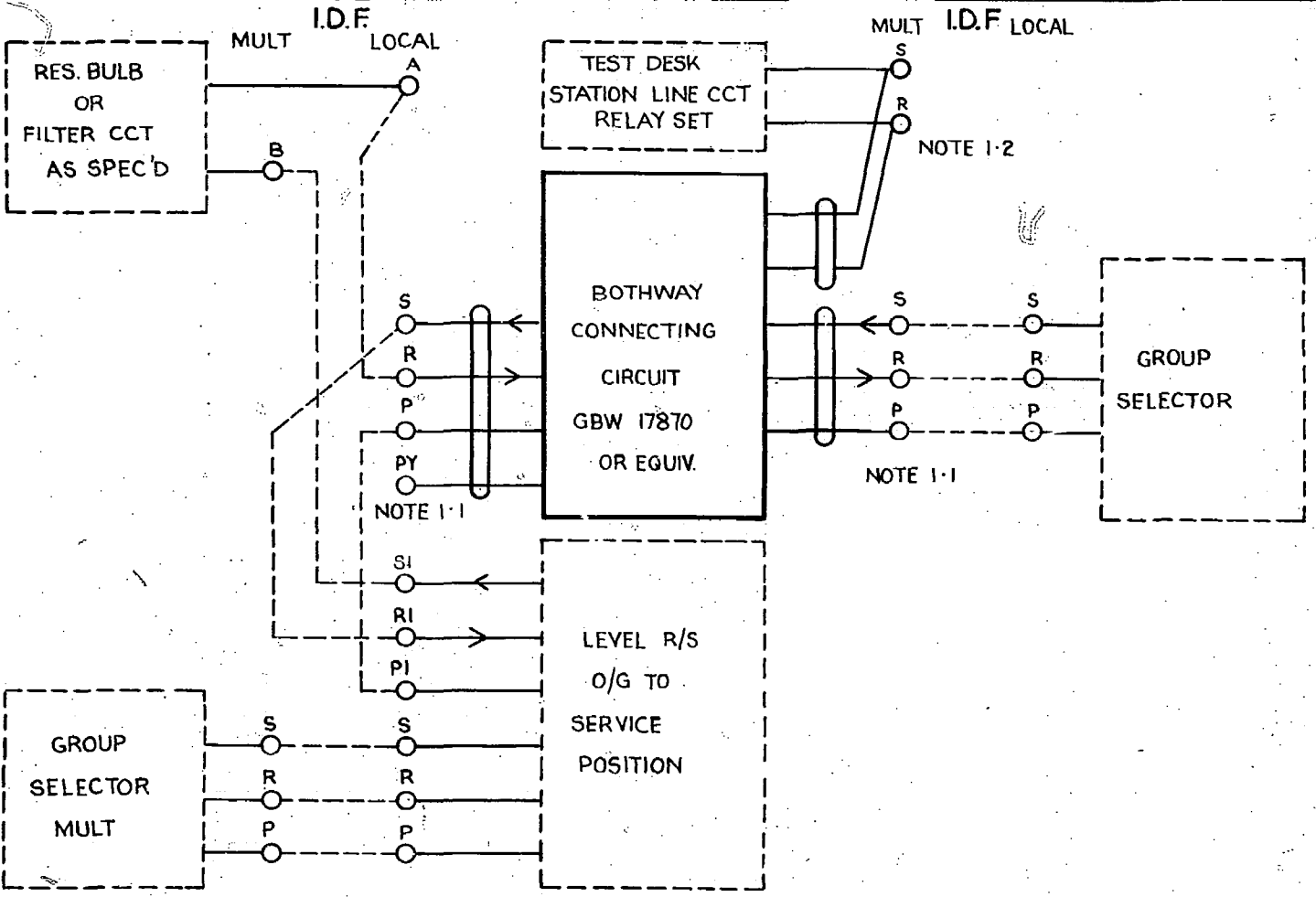
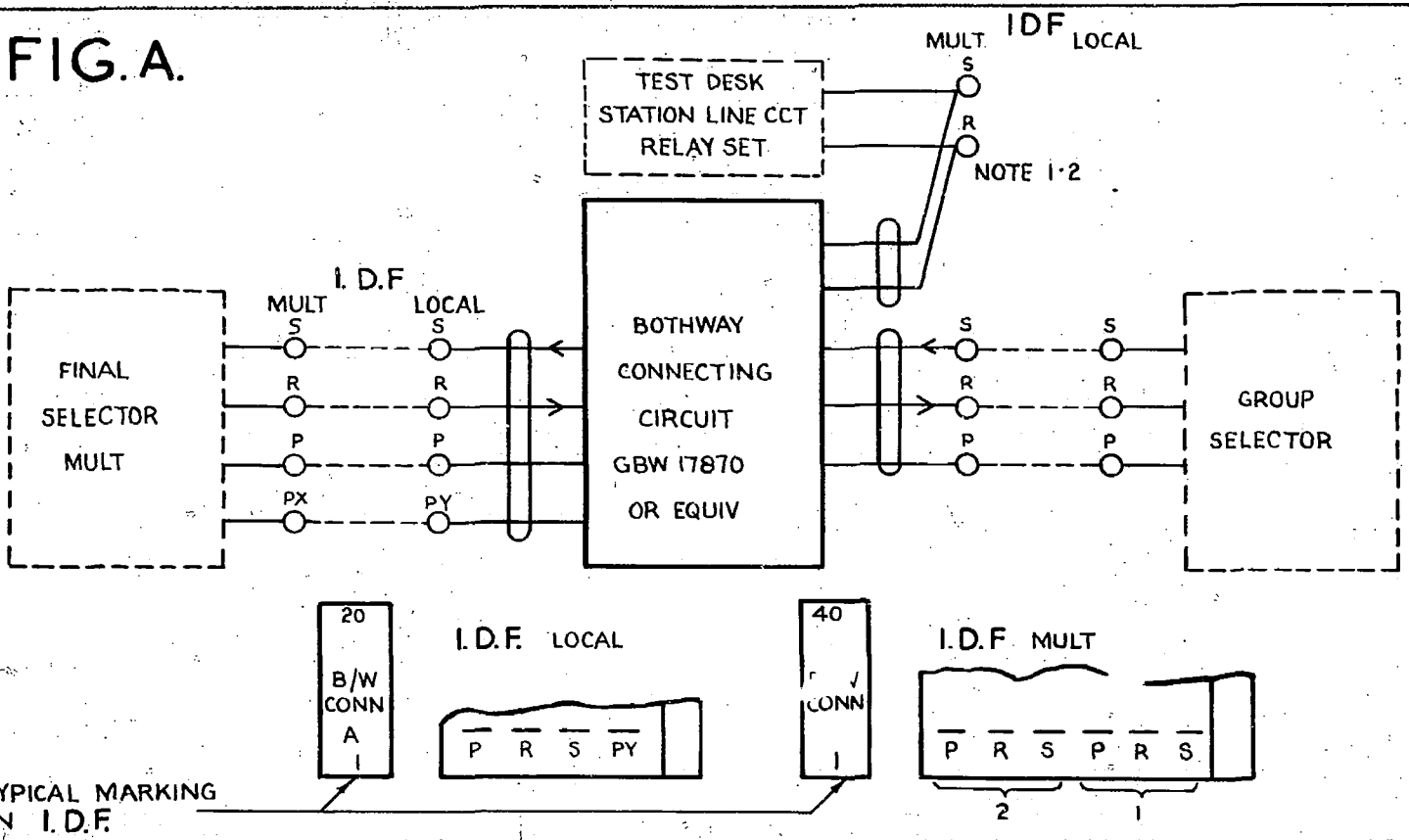

FIG.A.



NOTES

- 1-1 FOR MARKING OF CONN STRIP SEE FIG A
- 1-2 FOR MARKING OF CONN STRIP SEE GBX 17970 FIG G OR EQUIV

FIG.B

					AUTOMATIC TELEX SYSTEM	
					BOTHWAY CONNECTING CIRCUIT	
(86681)			1	8-4-68	Am	
AMENDMENT PARTICULARS			ISSUE	DATE	APP'D	E
N.Z.P.O.					DRAWN CHECKED WIRING CIRCUIT	
					GBX 17870	
					SHEET 1-2	

FIG. C.

I.D.F.

MULT LOCAL

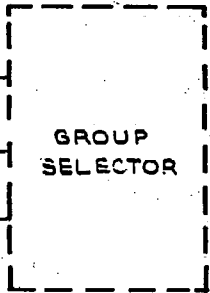
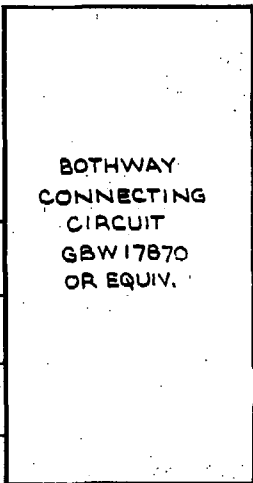
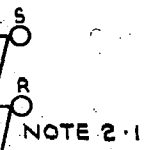
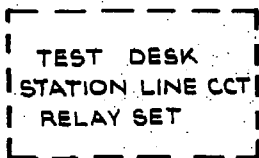

I.D.F.

MULT

LOCAL

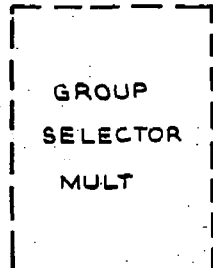
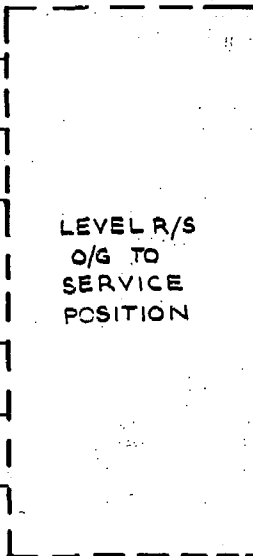
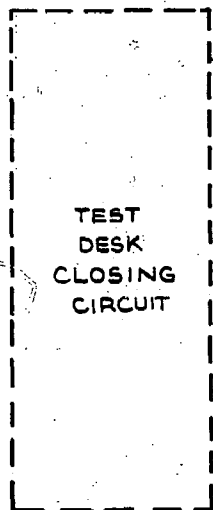

TYPICAL
MARKING
ON I.D.F.



I.D.F. LOCAL

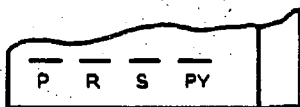

I.D.F. MULT

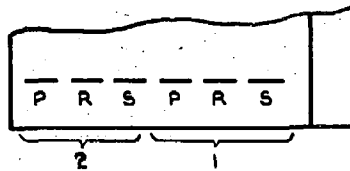

NOTES:-

2.1 FOR MARKING OF CONN. STRIP SEE GBX 17970 FIG. G. OR EQUIV.

					AUTOMATIC TELEX SYSTEM BOTHWAY CONNECTING CIRCUIT			
(86681)			1	8.4.68	Am			
AMENDMENT PARTICULARS			ISSUE	DATE	APPD	E		
					GBX 17870			
N.Z.P.O.		DRAWN	CHECKED	WIRING	CIRCUIT	SHEET 2-2		