

FIG.A GRADED FIRST SELECTOR WITH SUPERVISORY & METERING EQUIPMENT.

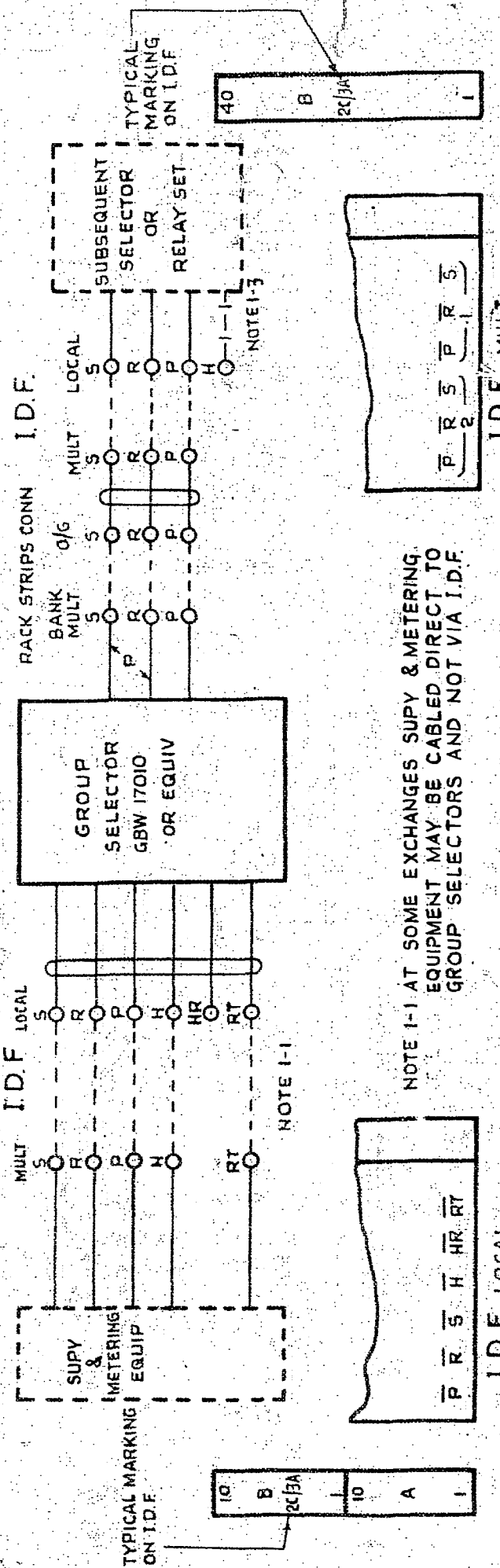
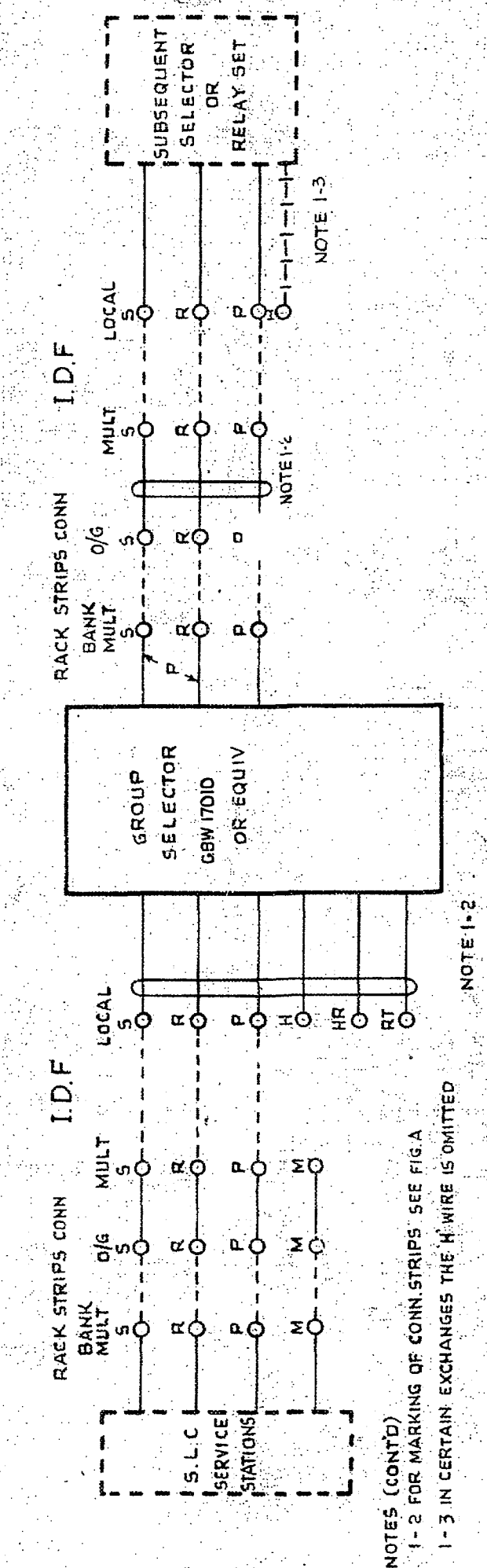

FIG.B GRADED FIRST SELECTOR WITHOUT SUPERVISORY & METERING EQUIPMENT



WAS SHEET 1-7	(86575)	2	12-12-67	A.M.
	(70502)	1	27-3-63	Lee
AMENDMENT PARTICULARS	ISSUE	DATE	APPD	
N.Z. P.O.	DRAWN	CHECKED	WIRING	CIRCUIT

AUTOMATIC TELEX SYSTEM
200 OUTLET
GROUP SELECTOR

GBX 17010

SHEET 1-8

FIG.C TRUNK FIRST SELECTOR (BOTHWAY)

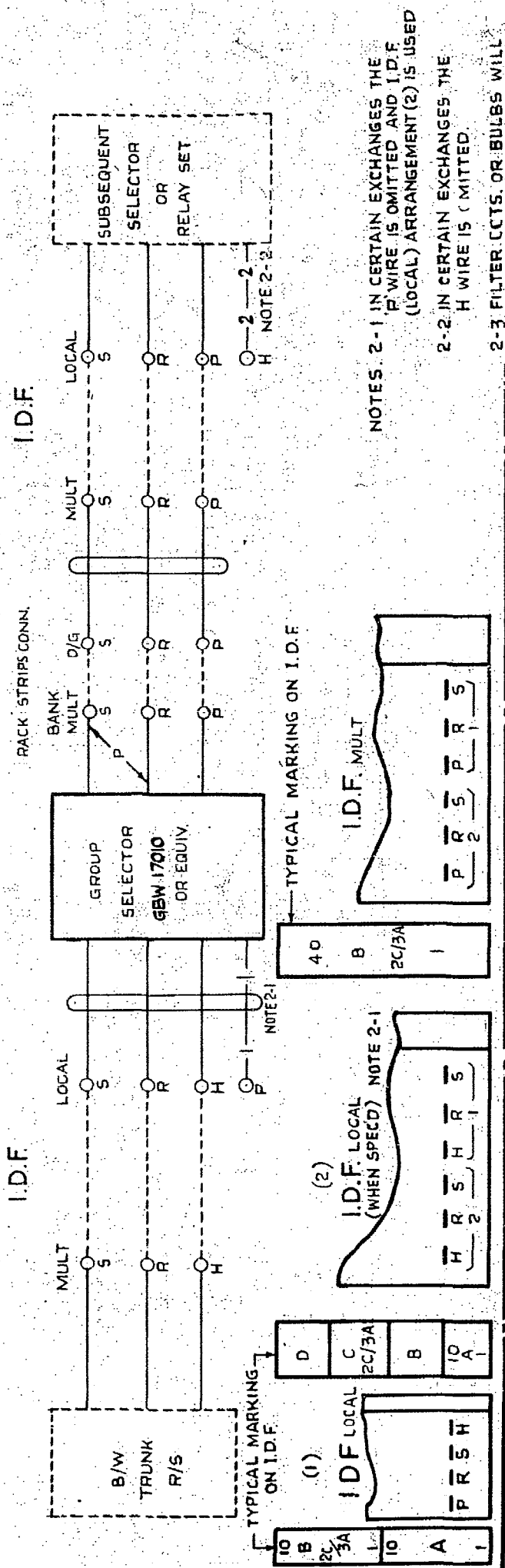
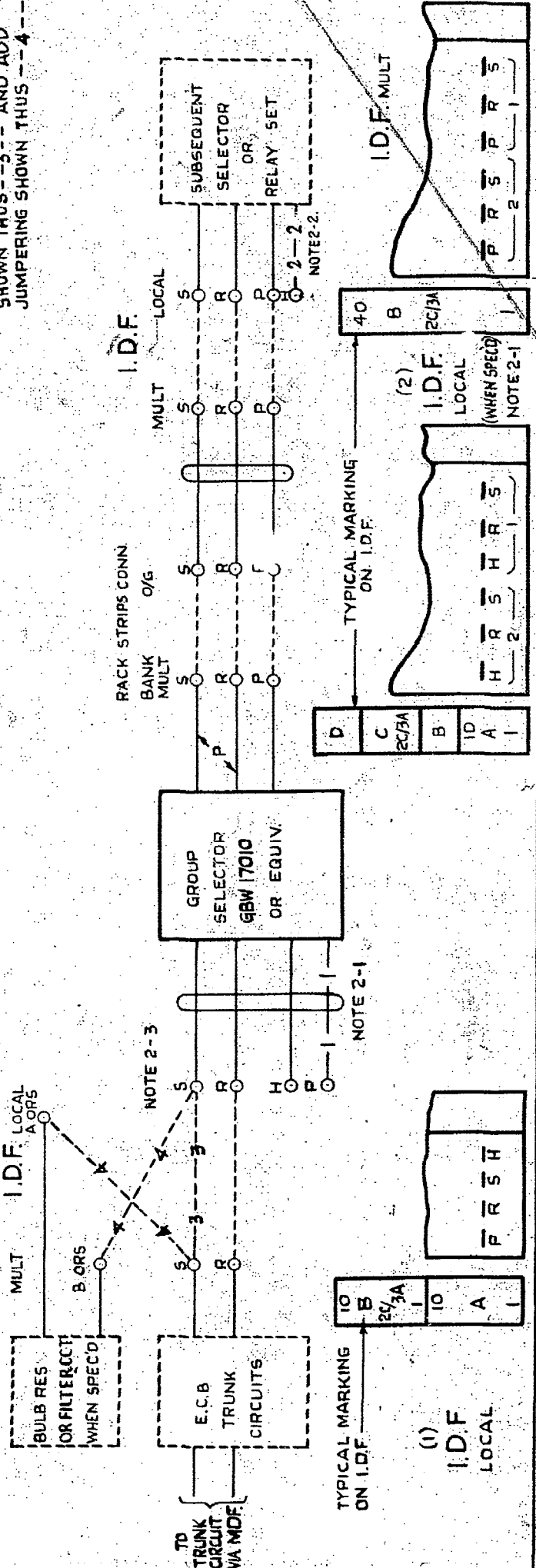
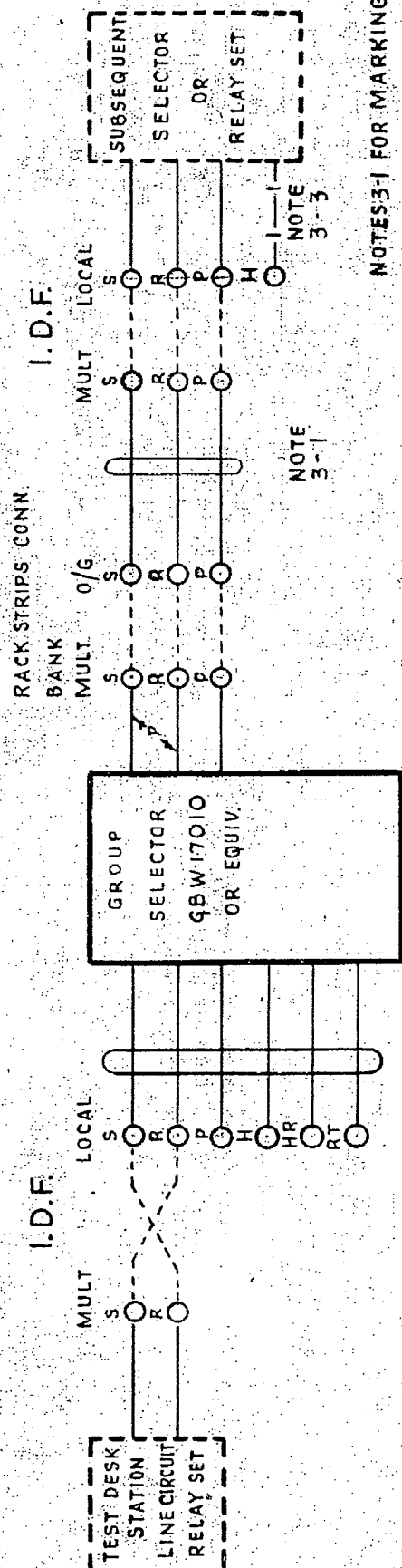

FIG.D TRUNK FIRST SELECTOR (INCOMING ONLY)



AUTOMATIC TELEX SYSTEM				
200 OUTLET				
GROUP SELECTOR				
WAS SHEET 2-7	(86575)	2	12-12-67	A.M.
	(10502)	1	27-3-63	
AMENDMENT PARTICULARS	ISSUE	DATE	APP'D	E
N.Z.P.O.	DRAWN	CHECKED	WIRING CIRCUIT	GBX 17010
				SHEET 2-B

FIG. E FIRST SELECTOR WITHOUT SUPY & METERING EQUIPMENT (DIRECTLY CONNECTED)



NOTE 3-1
NOTE 3-3
NOTES 3-1 FOR MARKING OF CONN. STRIPS SEE FIG. A. SHEET 1-7

3-2 'H' WIRE SHOWN - 2 - REQD ONLY FOR RELAY SETS

FIG. F SECOND, THIRD OR FOURTH SELECTOR

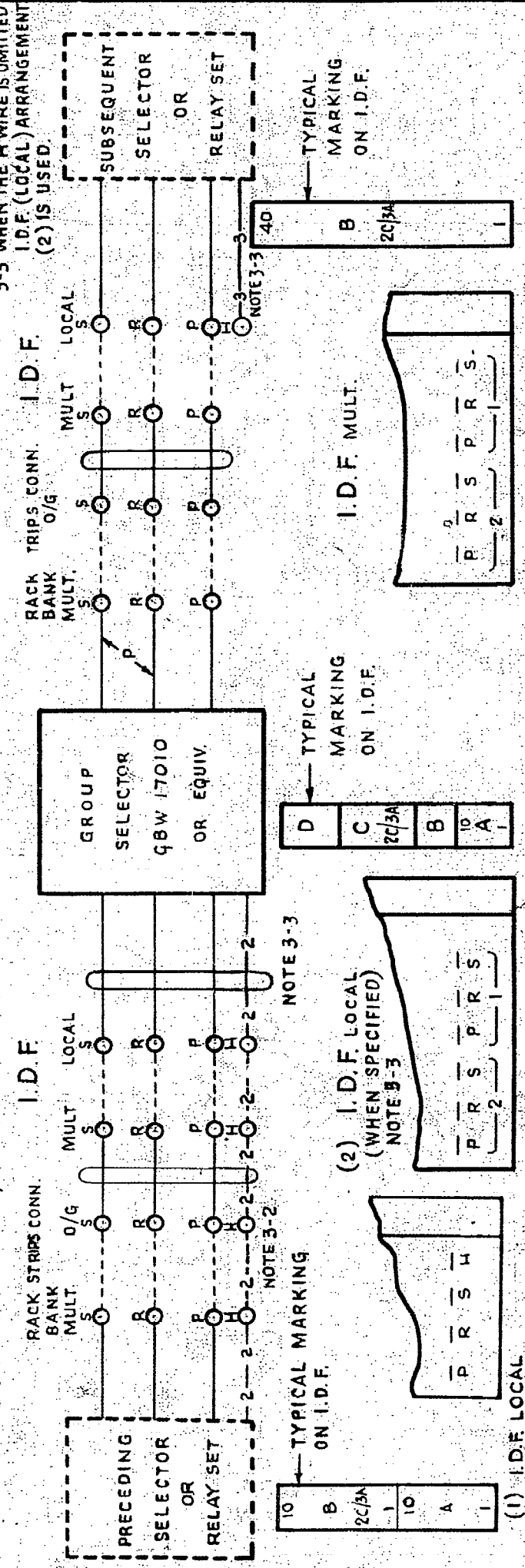

3-3 WHEN THE 'H' WIRE IS OMITTED I.D.F. (LOCAL) ARRANGEMENT (2) IS USED.

NOTE 3-2
NOTE 3-3
TYPICAL MARKING ON I.D.F.

WAS SHEET 3-7	(86575)	2	12-12-67	A M
	(70502)	1	27-3-63	
AMENDMENT PARTICULARS	ISSUE	DATE	APPD	
NZPO	DRAWN	CHECKED	WIRING	CIRCUIT

AUTOMATIC TELEX SYSTEM
200 OUTLET
GROUP SELECTOR

GBX 17010

SHEET 3-8

FIG. G. GRADED FIRST SELECTOR WITHOUT SUPY & METERING EQUIPMENT
 PRECEDED BY INTERNATIONAL DEMETERING CIRCUIT

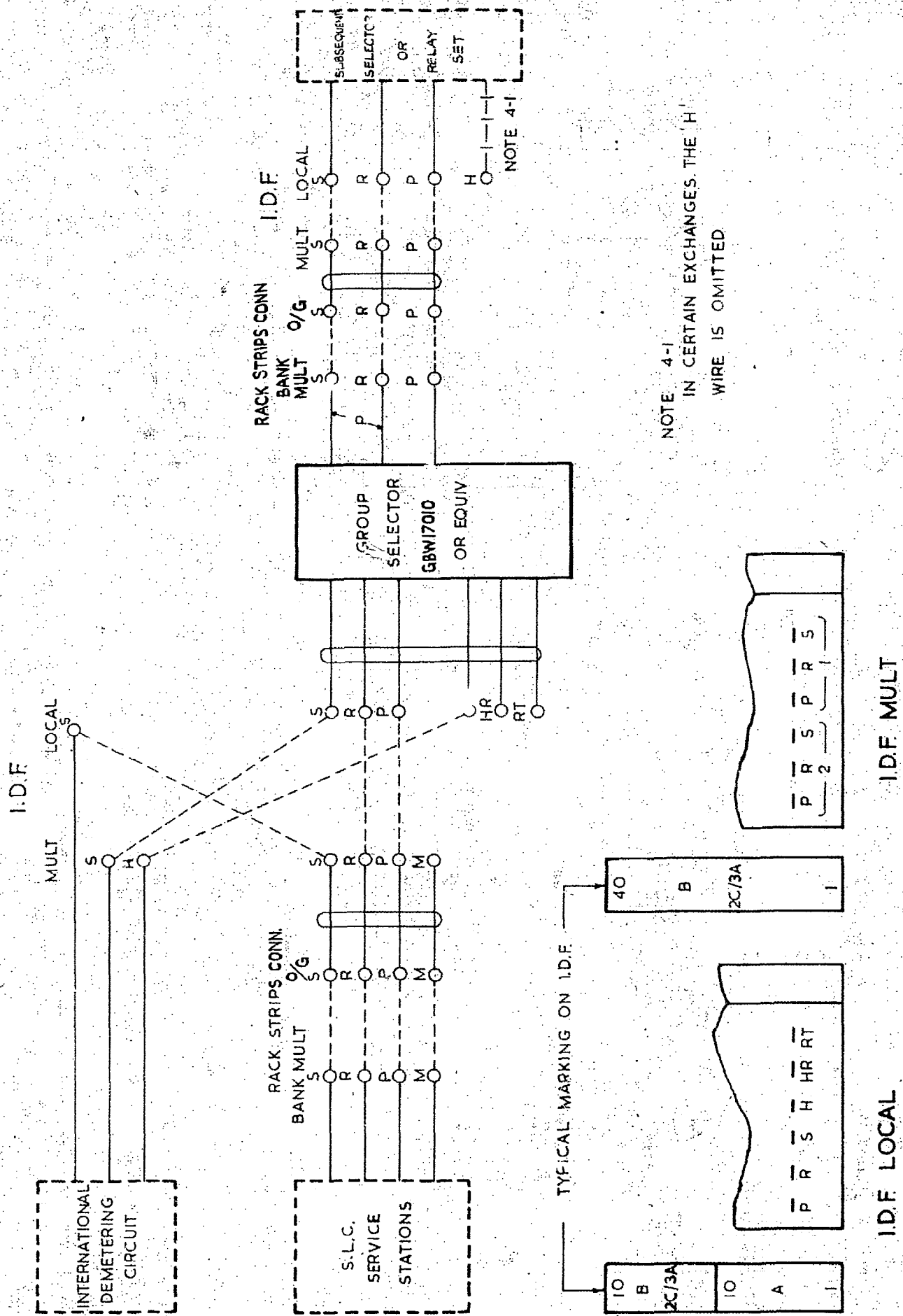

NOTE 4-1
 IN CERTAIN EXCHANGES THE 'H'
 WIRE IS OMITTED

N.Z.P.O.		DRAWN	CHECKED	WIRING	CIRCUIT
AMENDMENT PARTICULARS		ISSUE	DATE	APP'D	E
WAS SHEET 4-7		(86575)	2	12-12-67	A.M.
		(70502)	1	27-3-63	Fee

AUTOMATIC TELEX SYSTEM
 200 OUTLET
 GROUP SELECTOR

GBX 17010

FIG H TRUNK FIRST SELECTOR (INCOMING ONLY) PRECEDED BY INTERNATIONAL DEMETERING CIRCUIT

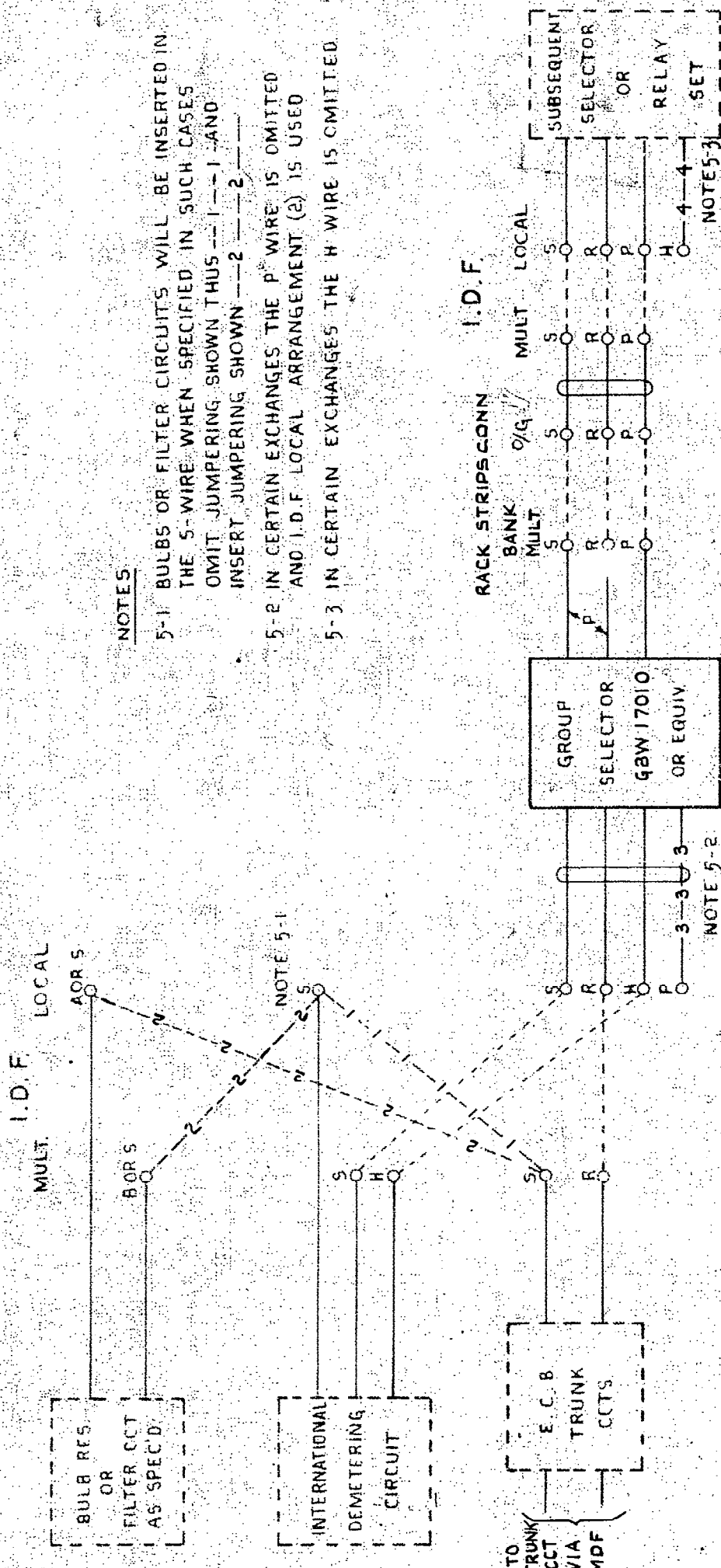

NOTES

- 5-1 BULBS OR FILTER CIRCUITS WILL BE INSERTED IN THE 5-WIRE WHEN SPECIFIED IN SUCH CASES OMIT JUMPERING SHOWN THUS ---1---1 AND INSERT JUMPERING SHOWN ---2---2
- 5-2 IN CERTAIN EXCHANGES THE P WIRE IS OMITTED AND I.D.F. LOCAL ARRANGEMENT (2) IS USED
- 5-3 IN CERTAIN EXCHANGES THE H WIRE IS OMITTED

TYPICAL MARKING ON I.D.F.

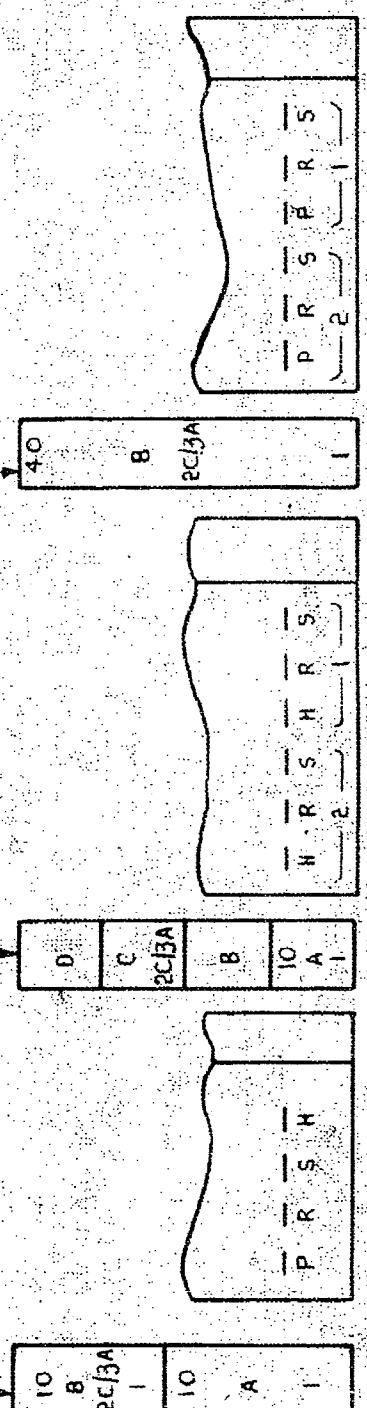

I.D.F. MULT.

NOTE 5-2 I.D.F. LOCAL (2)

I.D.F. LOCAL (1)

WAS SHEET 5-7

(86575) 2 12-12-67 A.M.
(70602) 1 27-3-63 *True*

AMENDMENT PARTICULARS

ISSUE DATE APP'D

N.Z.P.O.

DRAWN CHECKED WIRING CIRCUIT

GBX 17010

SHEET 5-8

AUTOMATIC TELEX SYSTEM
200 OUTLET
GROUP SELECTOR

**FIG J FIRST SELECTOR WITHOUT SUPY & METERING EQUIPMENT (DIRECTLY CONNECTED)
PRECEDED BY INTERNATIONAL DEMETERING CIRCUIT**

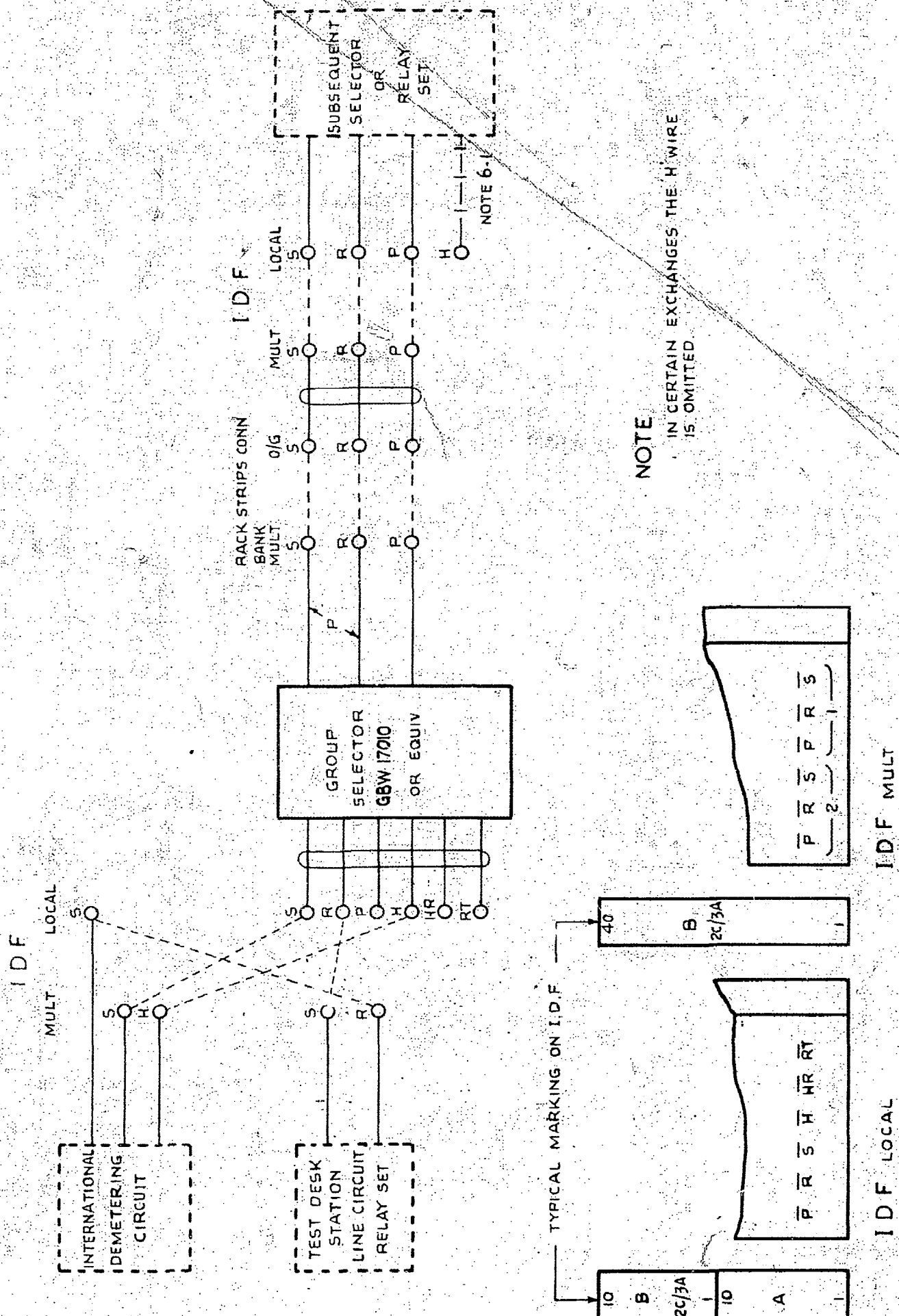

AMENDMENT	PARTICULARS	ISSUE	DATE	APP'D	E
NZ P.O.		DRAWN	CHECKED	WIRING	CIRCUIT

**AUTOMATIC TELEX SYSTEM
200 OUTLET
GROUP SELECTOR**

GBX 17010

**SHEET
6-8**

WAS SHEET 6-7 (86575) 2 12-12-67 A.M.
(70502) 1 27-3-63 *hr*

FIG K SECOND, THIRD OR FOURTH SELECTOR PRECEDED BY INTERNATIONAL DEMETERING CIRCUIT

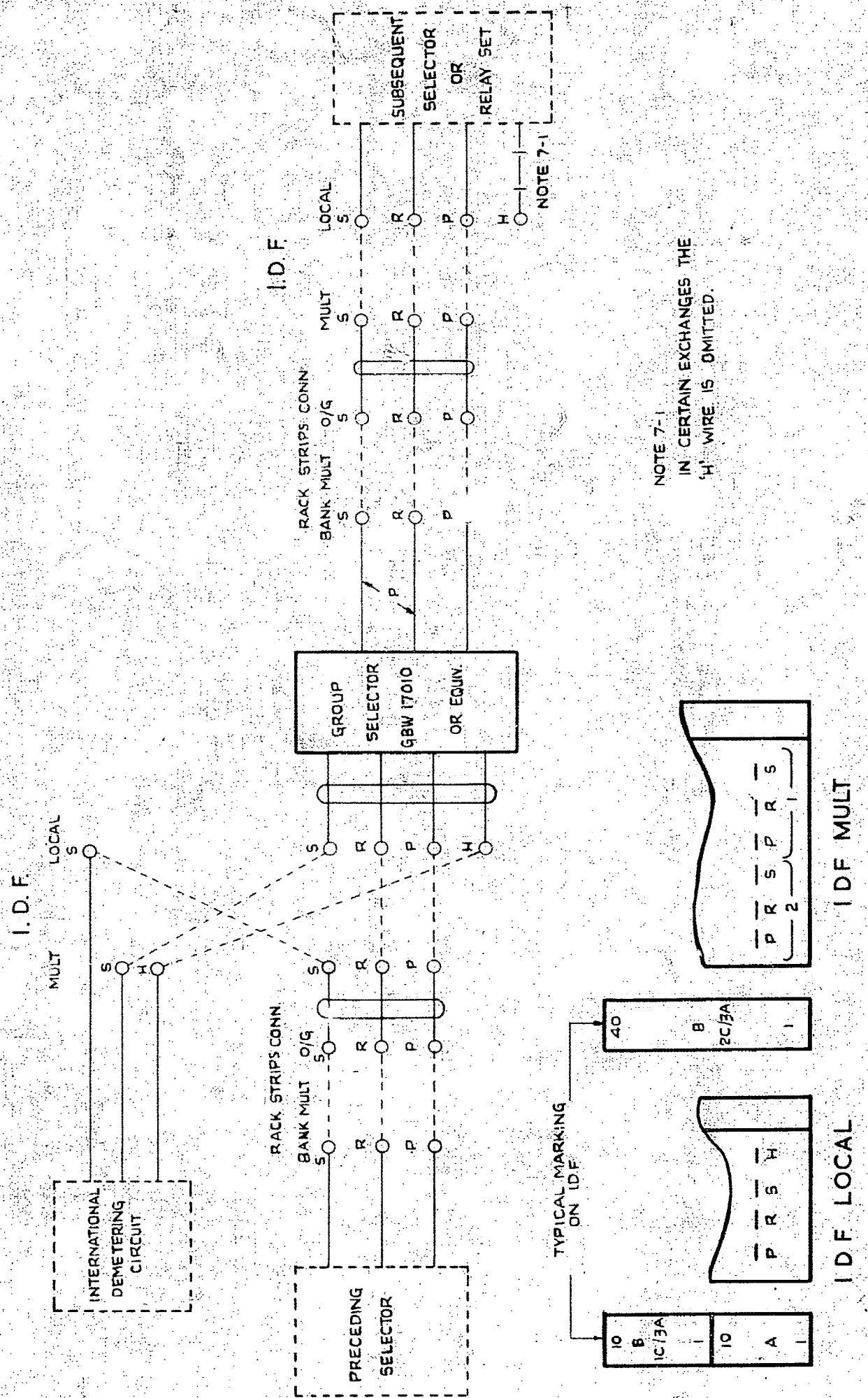

N.Z.P.O.					
	DRAWN	CHECKED	WIRING	CIRCUIT	
AMENDMENT PARTICULARS			ISSUE	DATE	APP'D
WAS SHEET 7-7			(86575)	2	12-12-67 A.M.
			(10502)	1	11-3-63

AUTOMATIC TELEX SYSTEM
200 OUTLET
GROUP SELECTOR

GBX 17010

SHEET 7-8

**FIG L FIRST SELECTOR WITHOUT SUPY & METERING EQUIPMENT
VIA BOTHWAY CONNECTING CIRCUIT**

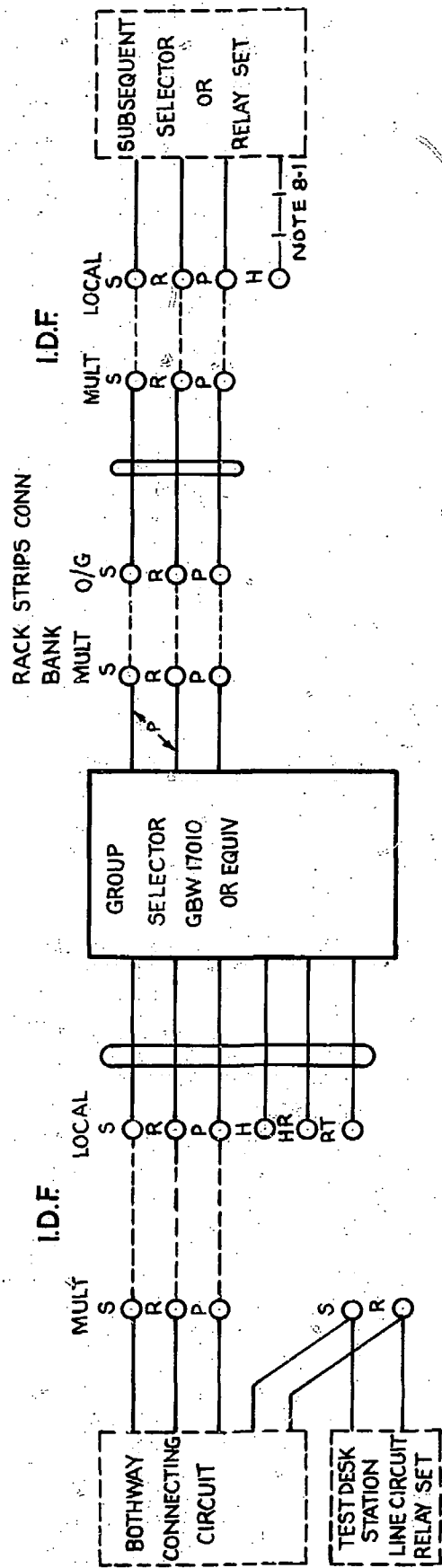

NOTE
8-1 IN CERTAIN EXCHANGES THE
'H' WIRE IS OMITTED

TYPICAL MARKING
ON I.D.F.

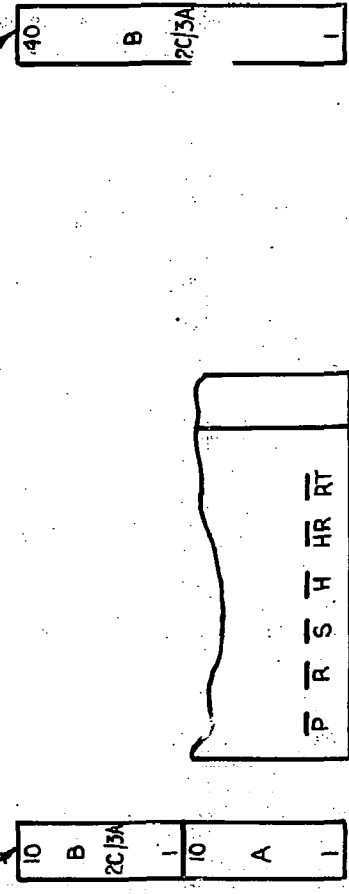

NZPO		DRAWN	CHECKED	WIRING	CIRCUIT
AMENDMENT PARTICULARS		(86375)	2	12-67	AM
		ISSUE	DATE	APPD	

AUTOMATIC TELEX SYSTEM
200 OUTLET
GROUP SELECTOR

GBX 17010