

TYPICAL MARKING

60
1/C
A.C.
No 2T
R/S
1A
1



CCT.3 CCT.2 CCT.1
M.D.F. EXCH.

TYPICAL MARKING

20
1/C
A.C.
No 2T
R/S
1A
1

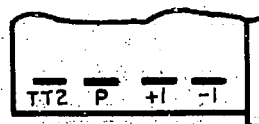

I.D.F. LOCAL

FIG.A.

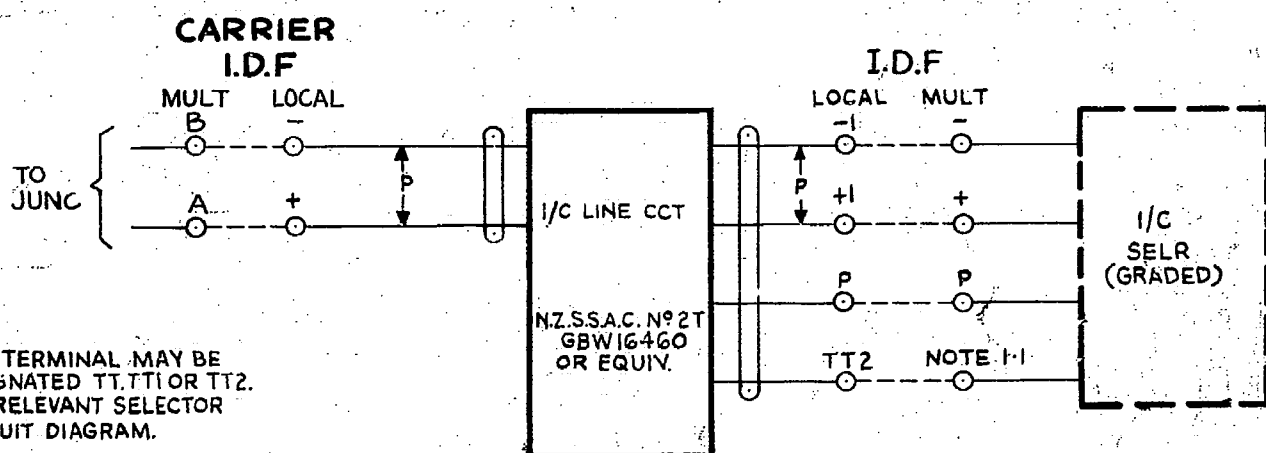

NOTES.

1:1 THIS TERMINAL MAY BE DESIGNATED TT.TT1 OR TT2. SEE RELEVANT SELECTOR CIRCUIT DIAGRAM.

TYPICAL MARKING

1
1/C
A.C.
No 2T
R/S
1A
60

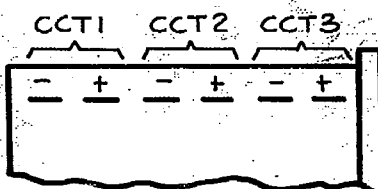

CARRIER I.D.F. LOCAL

TYPICAL MARKING

20
1/C
A.C.
No 2T
R/S
1A
1

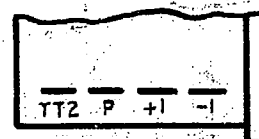

I.D.F. LOCAL

FIG.B.

| | | | | | | | |
|--|--|--|--|---|-------------------|---------------------------|---------------------------|
| | | | | 1/C LINE CIRCUIT N.Z. SIGNALLING SYSTEM A.C. No. 2T | | | |
| FIG.A REINSTATED.FIG.B CARR. I.D.F. BLK INVERTED(13812) | | | | 4 | 20-10-70 | RW | |
| FIG.A DELETED.FIG.B MAN.I.D.F. AMENDED TO CARR.I.D.F.(13812) | | | | 3 | 20-10-70 | RW | |
| TITLE AND CIRCUIT BOXES AMENDED(92971) | | | | 2 | 8-10-65 | JYL | |
| AMENDMENT PARTICULARS | | | | ISSUE | DATE | APP | REF:- I.V.F |
| N.Z.P.O. | | | | DRAWN D.M.G. | CHECKED D.M.G. | WIRING CIRCUIT FISH | GBX 16460 SHEET 1-3 |

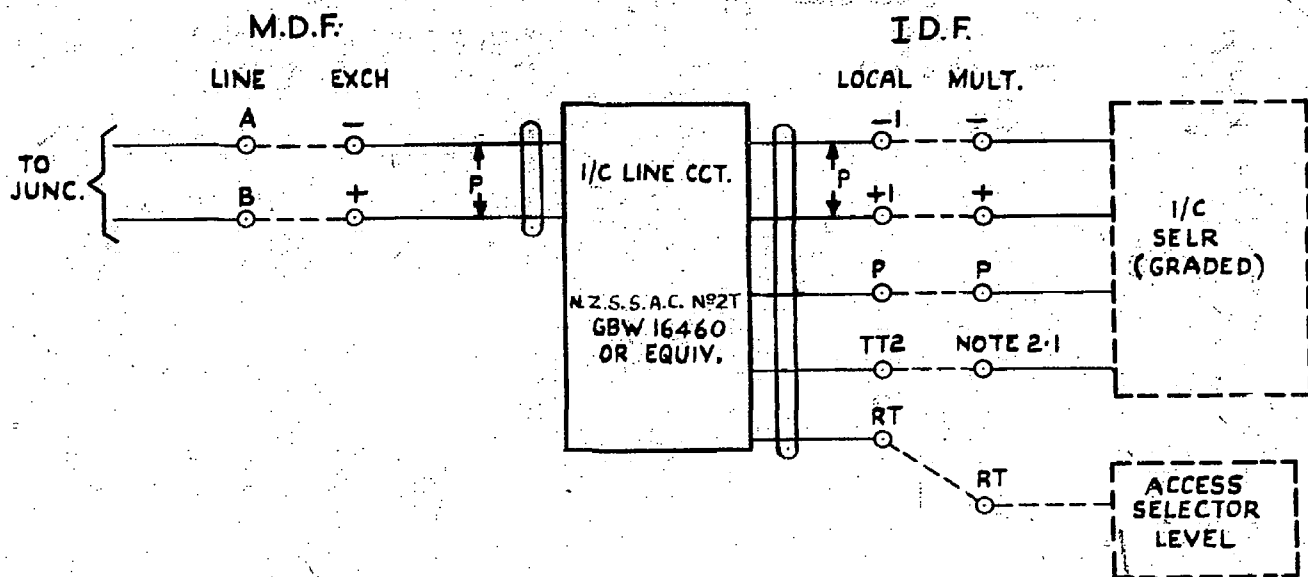

TYPICAL MARKING

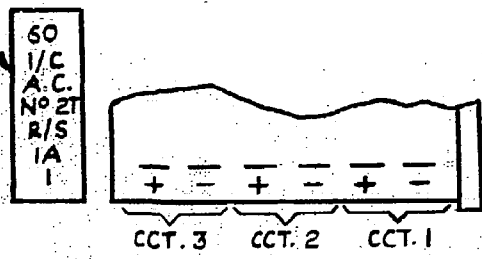

TYPICAL MARKING

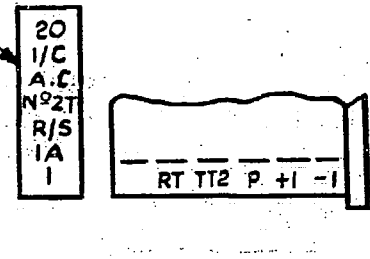
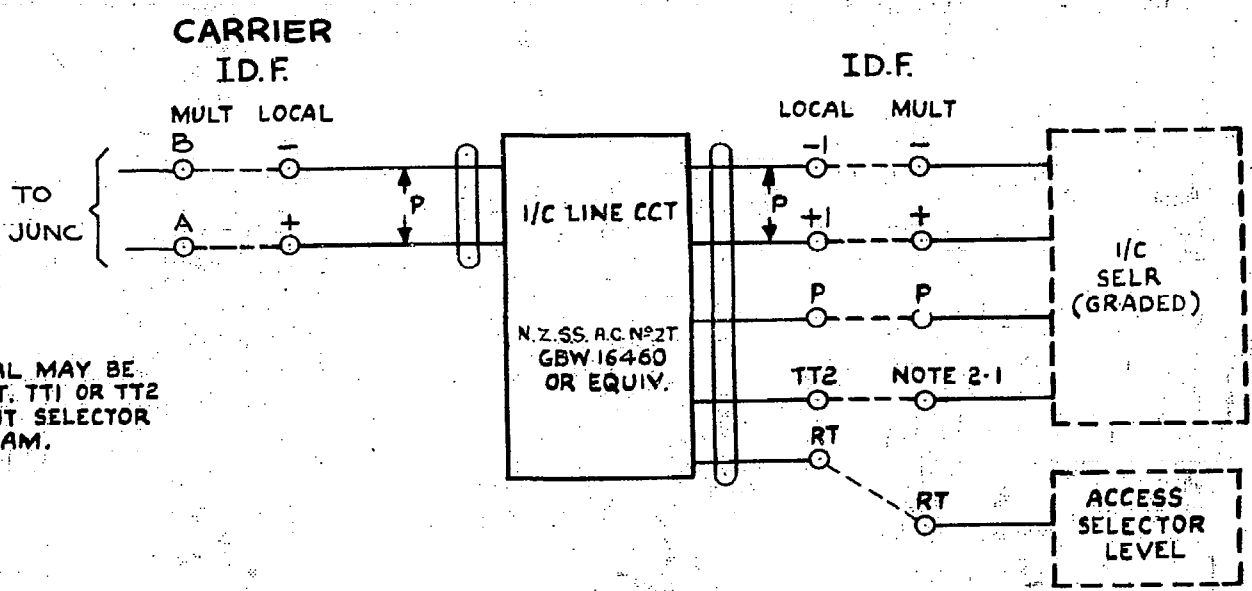

FIG. C

M.D.F. EXCH.

I.D.F. LOCAL



NOTES

2.1 THIS TERMINAL MAY BE DESIGNATED TT, TTI OR TT2 SEE RELEVANT SELECTOR CIRCUIT DIAGRAM.

TYPICAL MARKING

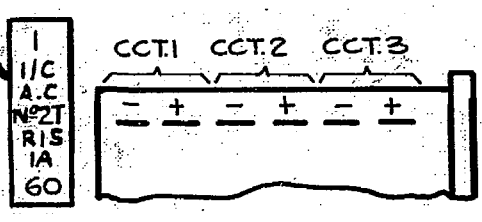

TYPICAL MARKING

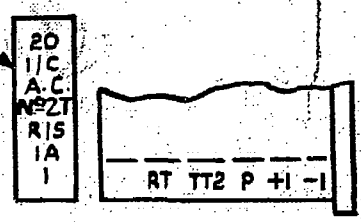

FIG. D

CARRIER I.D.F. LOCAL

I.D.F. LOCAL

| | | | | | |
|--|---|----------|--------------|---|-----------------------|
| | | | | 1/C LINE CIRCUIT N.Z. SIGNALLING SYSTEM A.C. No. 2T | |
| FIG. C REINSTATED. FIG. D. CARR. I.D.F. BLK INVERTED (13812) | 4 | 20.10.70 | RW | | |
| FIG. C. DELETED. FIG. D. MAN. I.D.F. AMENDED TO CARR. I.D.F. (13812) | 3 | 20.10.70 | RW | | |
| TITLE AND CIRCUIT BOXES AMENDED (92971) | 2 | 8.10.65 | VC | | |
| AMENDMENT PARTICULARS | | | ISSUE DATE | APP | REF - I.V.F. |
| | | | | | S |
| N.Z.P.O. | | | DRAWN DMG | CHECKED DMG | WIRING CIRCUIT ASH |
| GBX 16460 | | | | | SHEET 2-3 |

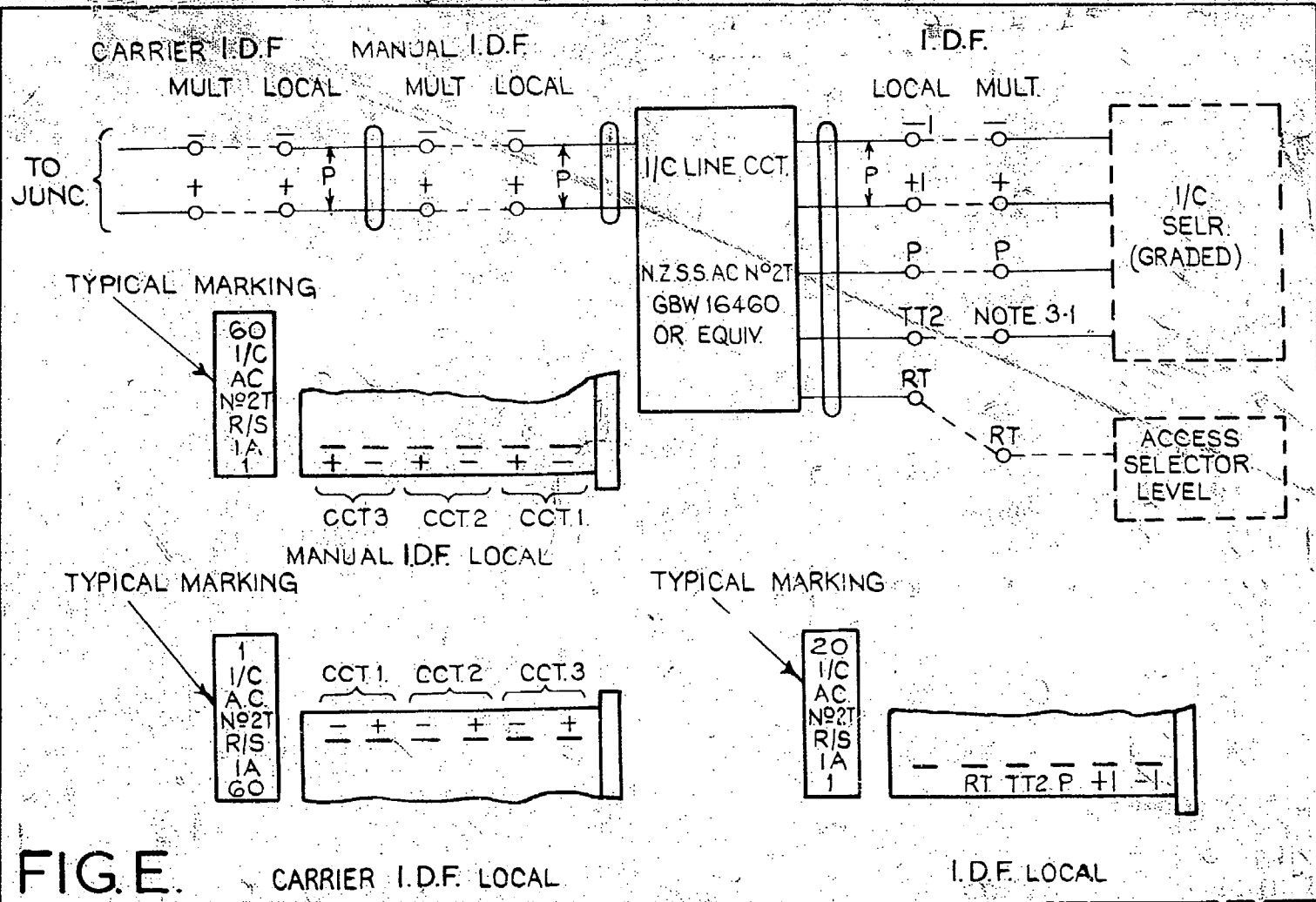

FIG. E. CARRIER I.D.F. LOCAL I.D.F. LOCAL

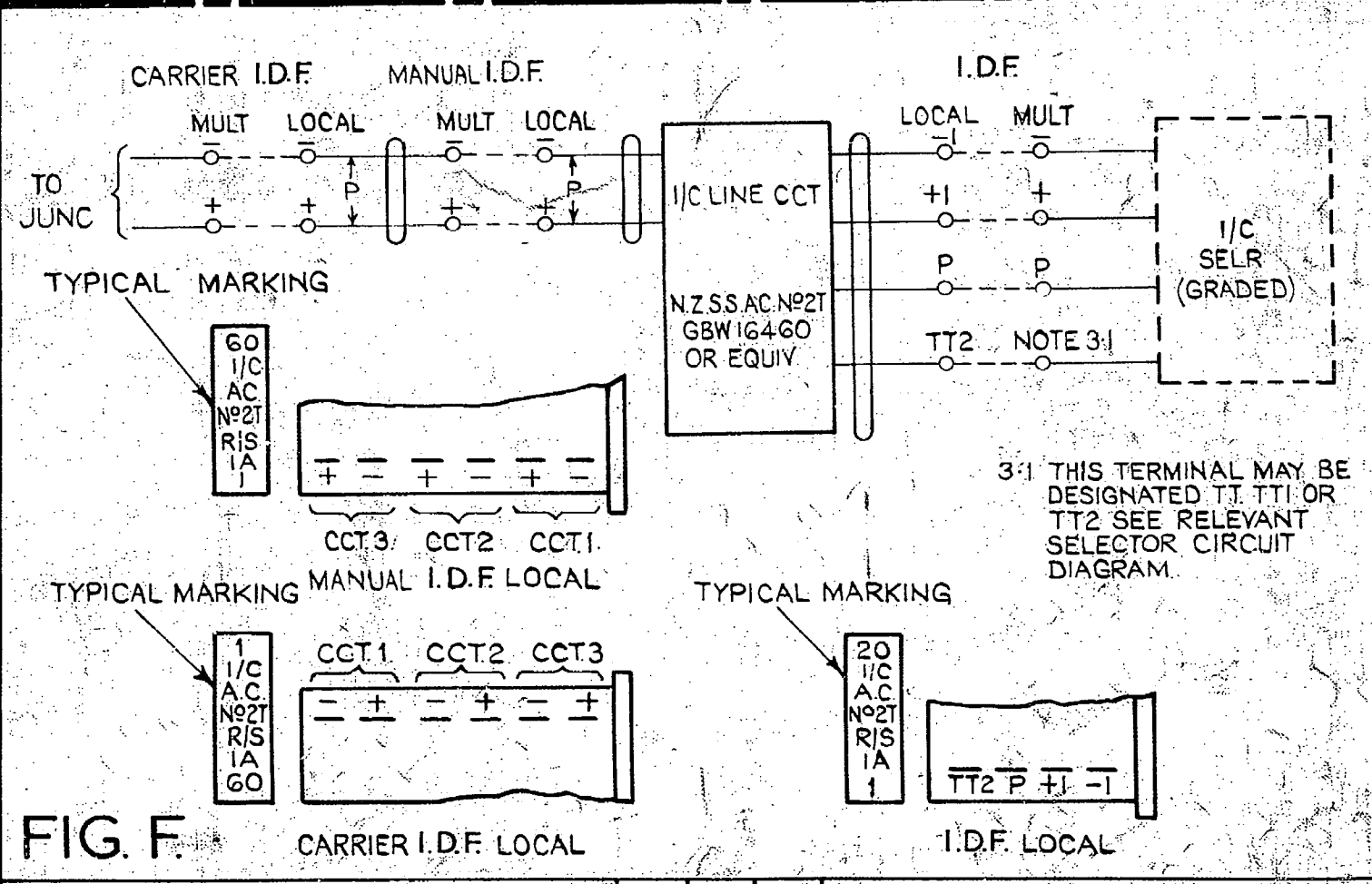

FIG. F. CARRIER I.D.F. LOCAL I.D.F. LOCAL

| | | | | | | | |
|-----------------------|--|--|--|---|------|------------------|------------|
| | | | | I/C LINE CIRCUIT N.Z. SIGNALLING SYSTEM A.C. No. 2T | | | |
| | | | | (13812) 4 20/10/70 RW | | | |
| AMENDMENT PARTICULARS | | | | ISSUE | DATE | APP ^o | REF I.V.F. |
| N.Z.P.O. | | | | DRAWN CHECKED E. RIG | | WIRING CIRCUIT | |
| GBX 16460 | | | | | | SHEET 3-3 | |