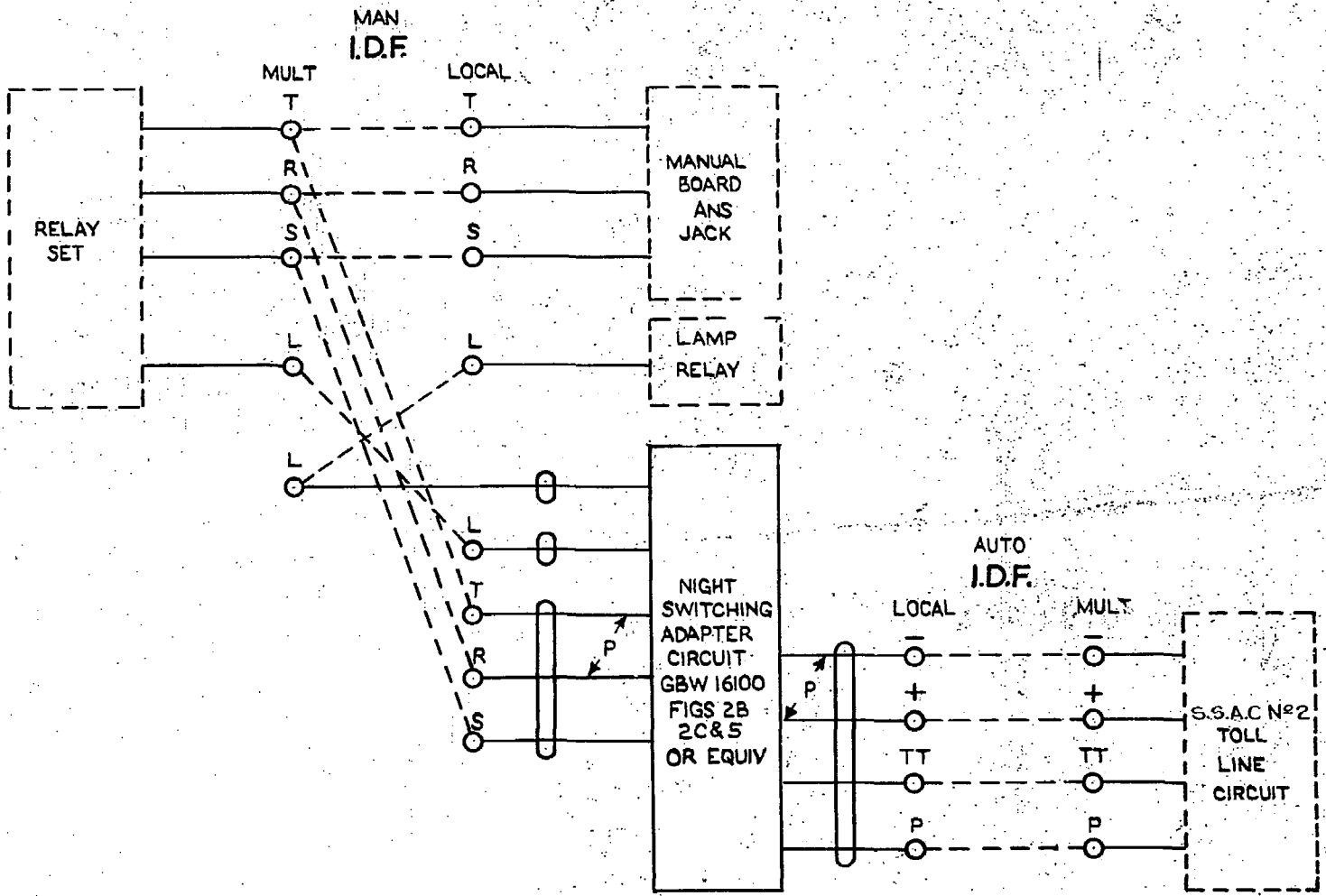
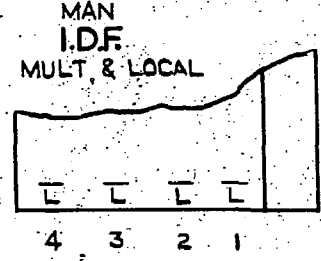
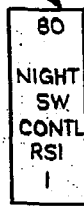
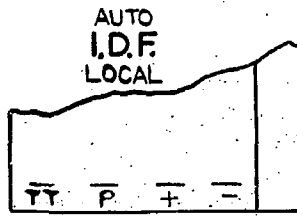
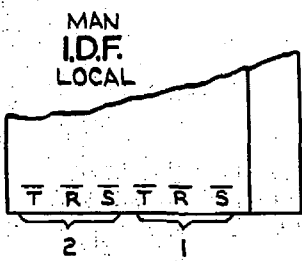

FIG. A ORD. OR. CCB GROUPS



TYPICAL MARKING



					NIGHT SWITCHING ADAPTER AND CONTROL CIRCUITS TO N.Z. S.S.A.C No 2 TRUNKS	
WAS SHEET 1-2 TITLE AMENDED (G9003) 2 6.9.63 DBH (74867) 1 20.8.63 DBH						
AMENDMENT PARTICULARS			ISSUE	DATE	APPD.	REF. ES120 SCHEME D
NZPO.			DRAWN	CHECKED	WIRING /CIRCUIT	GBX16100
						SHEET 1/4

FIG. B COMBINED ORD AND CCB GROUPS.

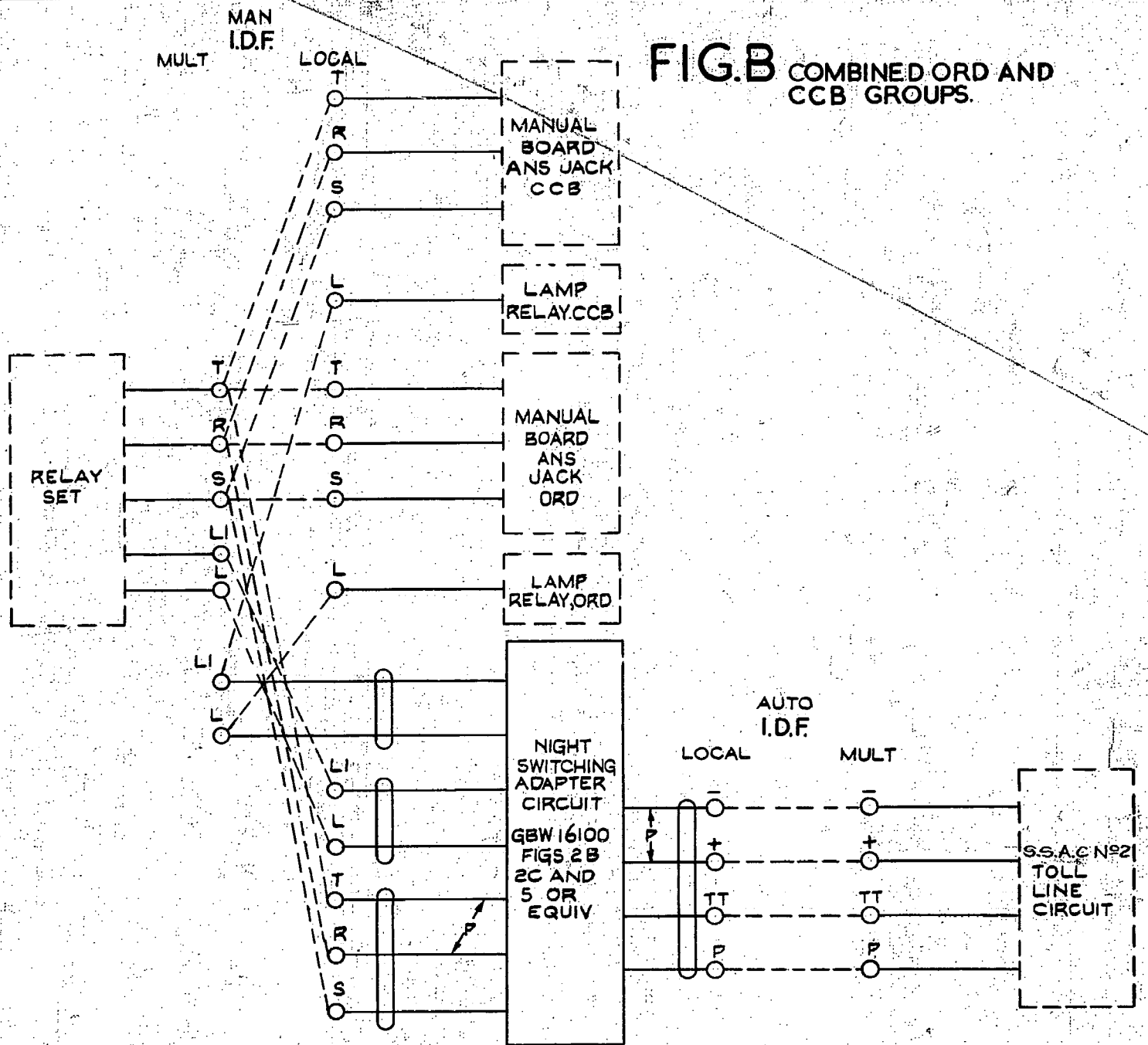

TYPICAL MARKING

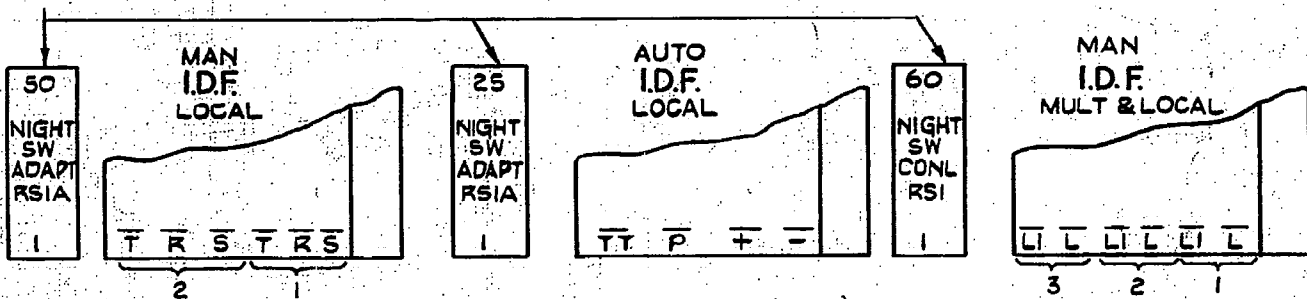

				NIGHT SWITCHING ADAPTER AND CONTROL CIRCUITS TO N.Z.SSAC N92 TRUNKS			
WAS SHEET 2-2, TITLE AMENDED		(63003)	2	6-9-63	DBX		
		(74867)	1	20-8-63	DBX		
AMENDMENT PARTICULARS			ISSUE	DATE	APPD.	REF ES120 SCHEME D	E
				GBX 16100			
NZPO		DRAWN	CHECKED	WIRING	CIRCUIT	SHEET 2-4	

FIG. C. ORD. OR CCB. GROUPS. MANUAL BOARD IN REMOTE BUILDING

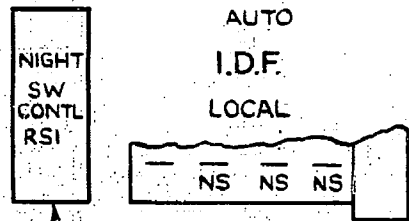
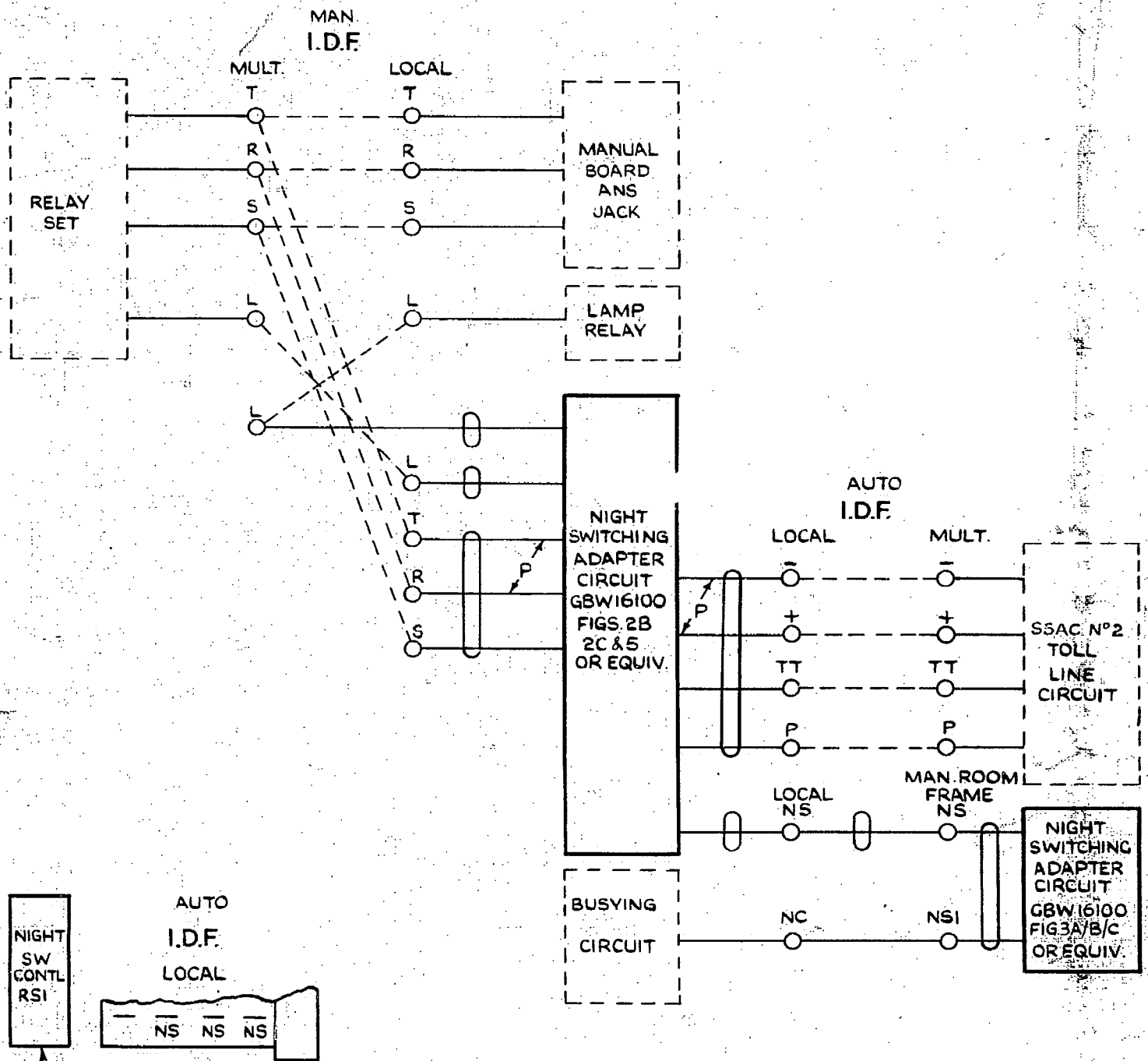

TYPICAL MARKING

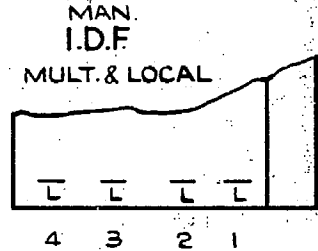
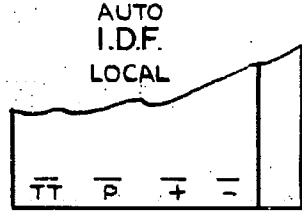
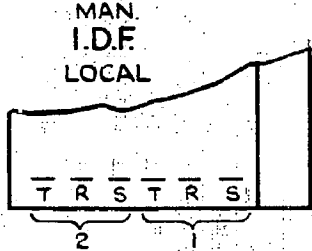

NIGHT SWITCHING ADAPTER AND CONTROL CIRCUITS TO N.Z. SSAC.No.2. TRUNKS

		(G9003)	2	6.9.63	DBH
AMENDMENT PARTICULARS		ISSUE	DATE	APPD.	REF ES120 SCHEM D
N.Z. P.O.		DRAWN	CHECKED	WIRING CIRCUIT	

GBX16100

FIG. D COMBINED ORD. AND CCB. GROUPS

MANUAL BOARD IN REMOTE BUILDING

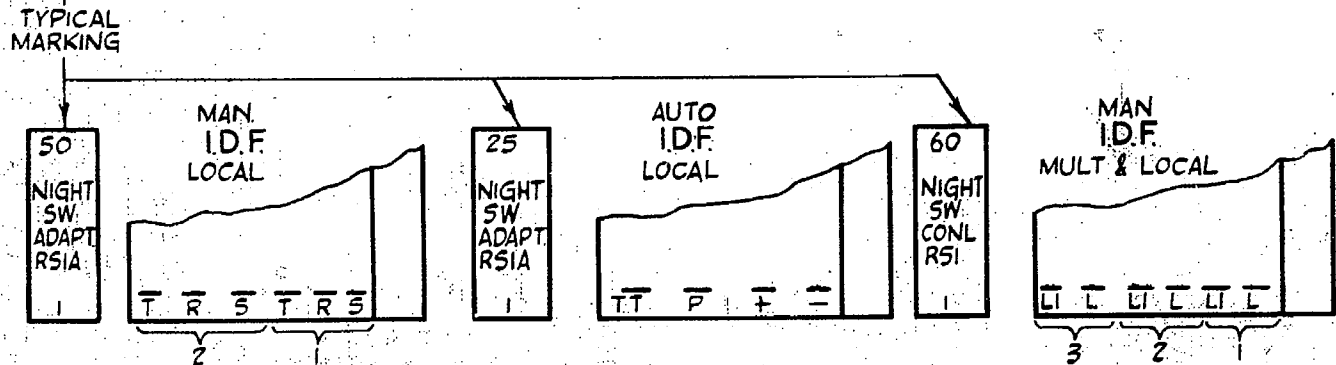
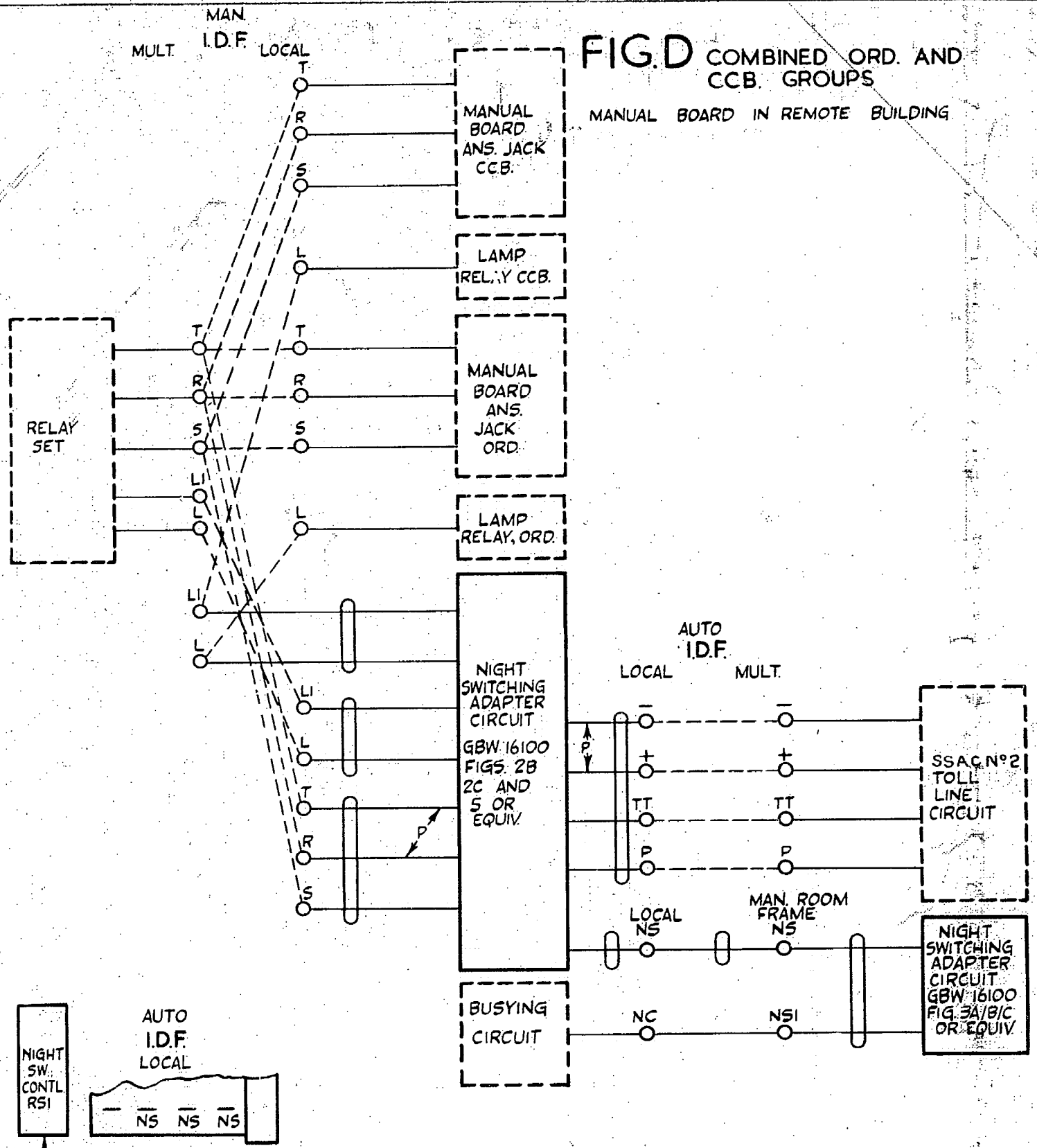

NIGHT SWITCHING ADAPTER & CONTROL CIRCUITS TO NZ. SSAC. NO 2 TRUNKS

(G9003) 2 G. 9. 63 DBN

AMENDMENT PARTICULARS ISSUE DATE APPR REF. ES120 SCHEME D E

N.Z.P.O.

DRAWN CHECKED WIRING CIRCUIT

GBX 16100

SHEET 4-4