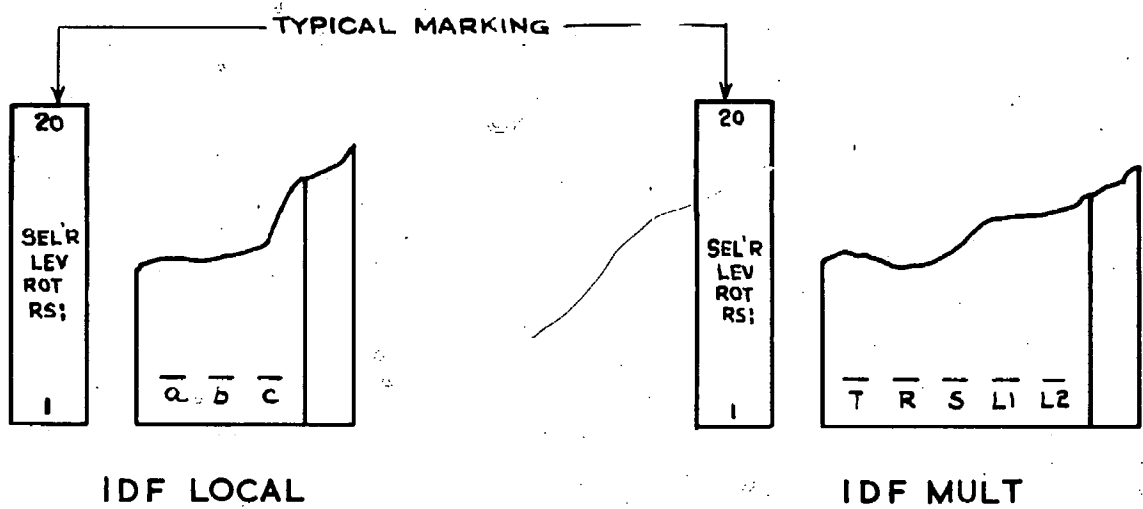
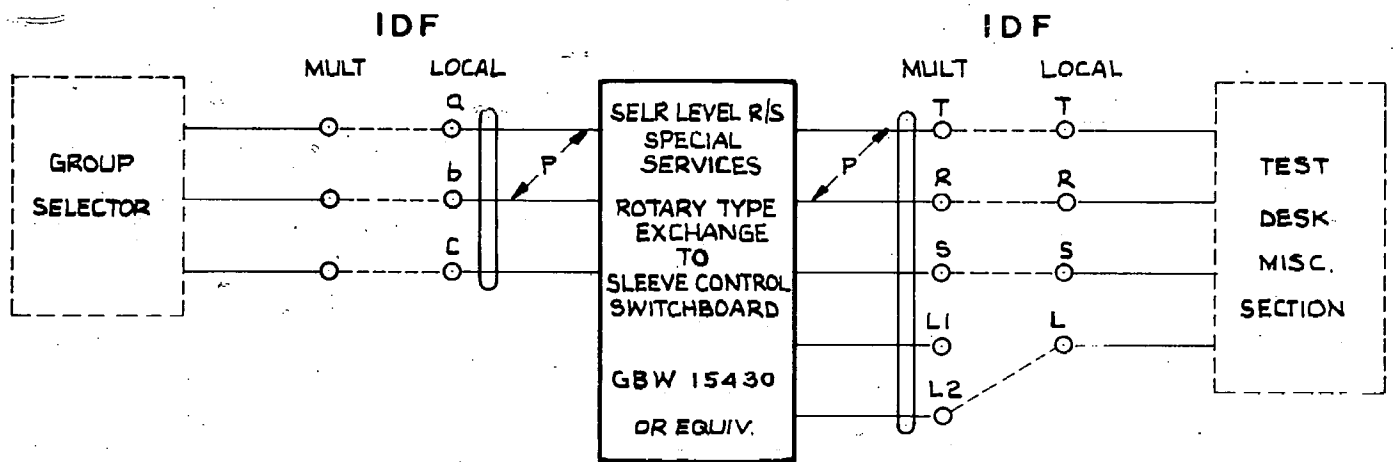
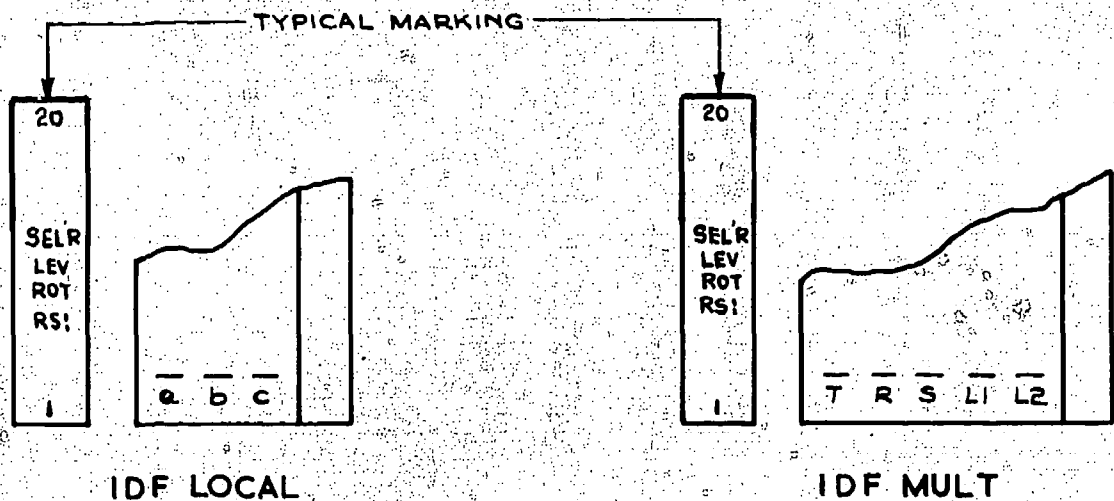
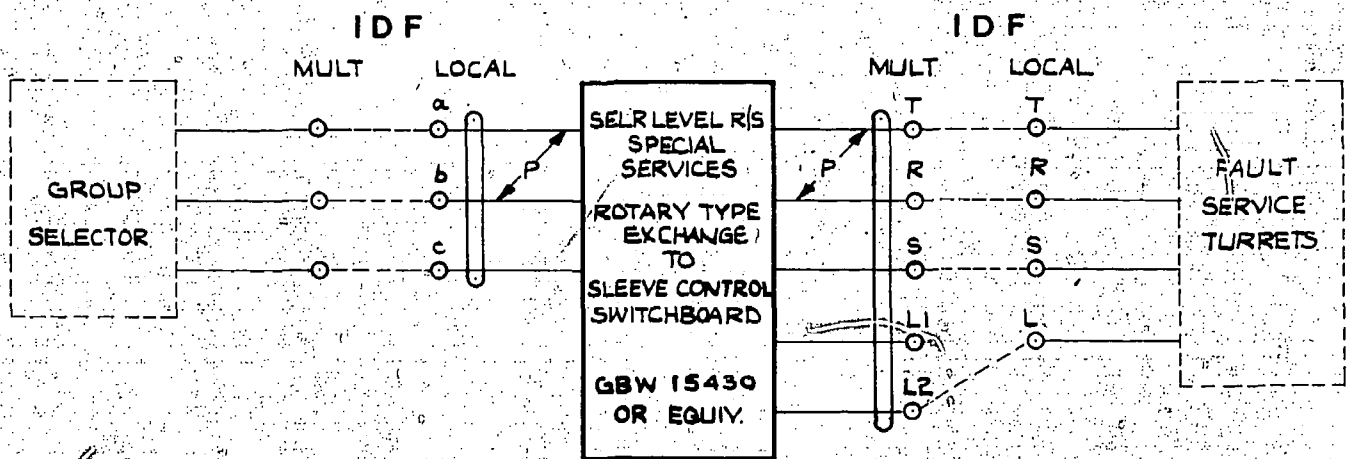

**FIG. 1A** WHEN CABLED TO TEST DESK MISC. SECTION



				SELECTOR LEVEL R/S SPECIAL SERVICES ROTARY TYPE EXCHANGE TO SLEEVE CONTROL SWITCHBOARD			
				(7588)	1	11:4:69	<i>[Signature]</i>
AMENDMENT PARTICULARS				ISSUE	DATE	APP	W
N.Z.P.O.				DRAWN	CHECKED	WIRING	CIRCUIT
				<b>GBX 15430</b>			SHEET 1-4

**FIG. 1B** WHEN CABLED TO FAULT SERVICE TURRETS



					<b>SELECTOR LEVEL R/S SPECIAL SERVICES ROTARY TYPE EXCHANGE TO SLEEVE CONTROL SWITCHBOARD</b>	
					(7588)	11-4-69
AMENDMENT PARTICULARS					ISSUE	DATE
					APPD	W
					<b>GBX 15430</b>	
N.Z.P.O.		DRAWN P.K.	CHECKED	WIRING	CIRCUIT	<b>SHEET 2-4</b>

**FIG. 1C**

WHEN CABLED TO DIRECTORY SERVICE & PRICING DESK TURRETS

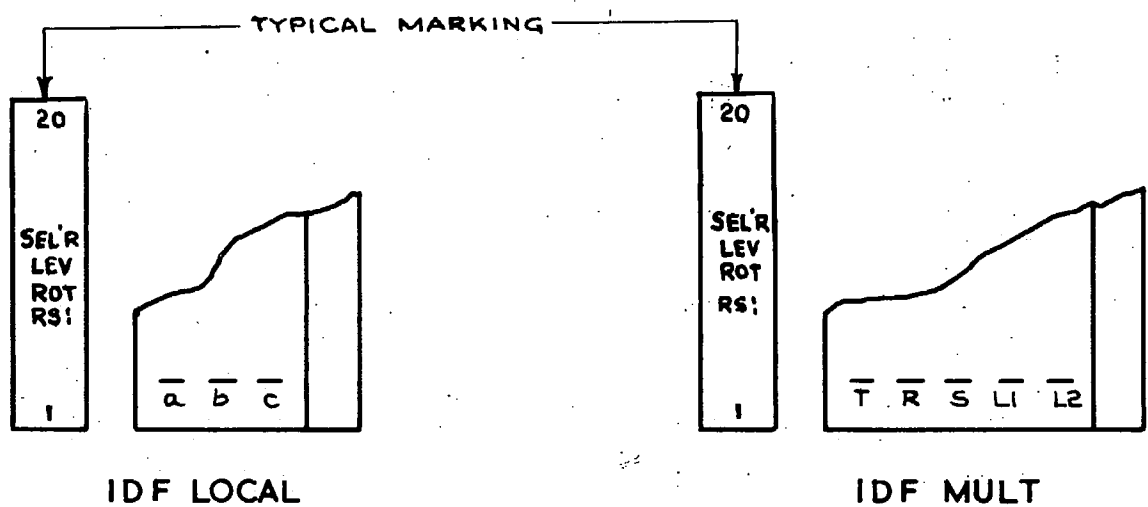
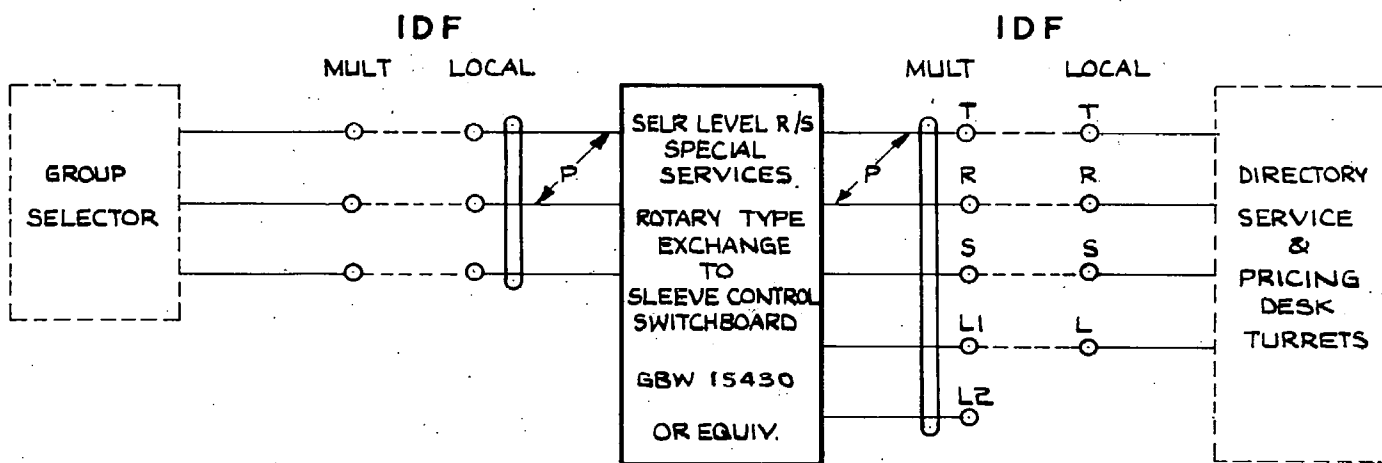

IDF LOCAL

IDF MULT

				SELECTOR LEVEL R/S SPECIAL SERVICES ROTARY TYPE EXCHANGE TO SLEEVE CONTROL SWITCHBOARD	
(7588)				1	11-4-69
AMENDMENT PARTICULARS			ISSUE DATE	APPD.	W
				GBX 15430	
N.Z.P.O.	DRAWN PK.	CHECKED	WIRING	CIRCUIT	SHEET 3-4

**FIG. 1D** WHEN CABLED TO S.C.S. MANUAL BOARDS

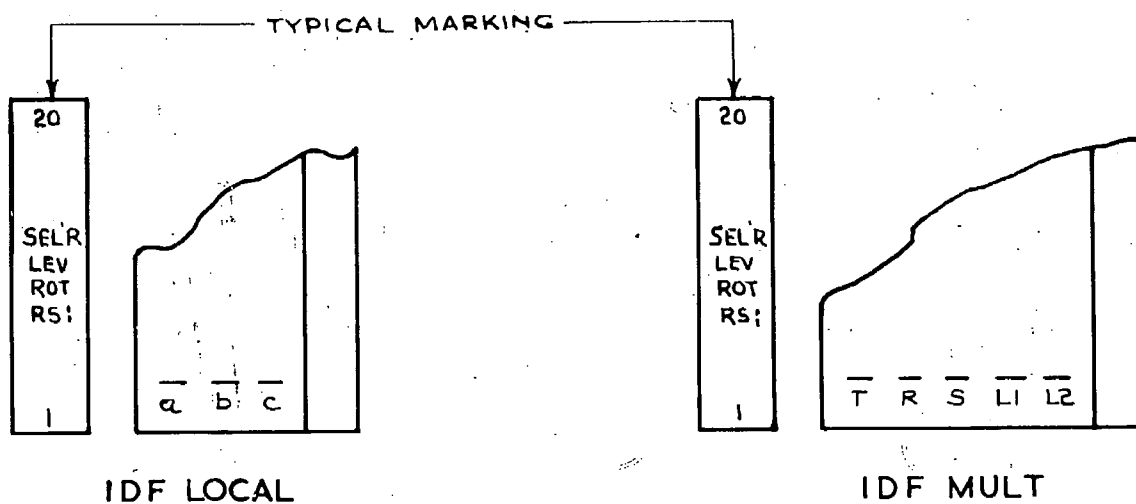
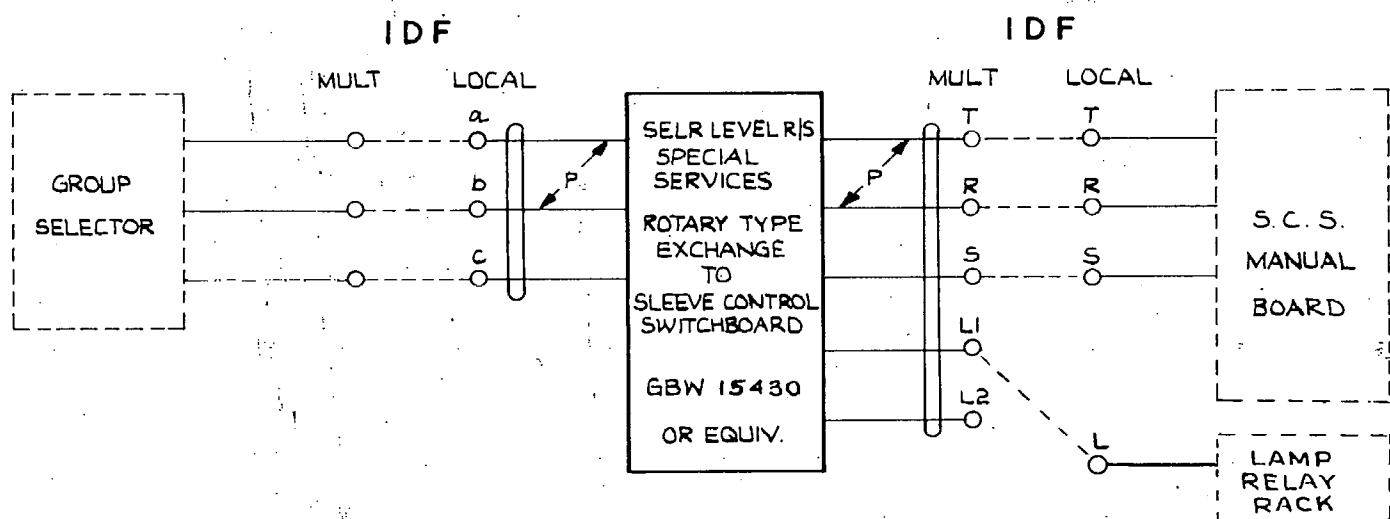

					<b>SELECTOR LEVEL R/S SPECIAL SERVICES ROTARY TYPE EXCHANGE TO SLEEVE CONTROL SWITCHBOARD</b>					
					(7588)	1	11-4-69	<i>SP.</i>		
AMENDMENT PARTICULARS					ISSUE	DATE	APP			W
					<b>GBX 15430</b>			SHEET		
								4-4		
N.Z.P.O.			DRAWN PK.	CHECKED	WIRING	CIRCUIT				