

FIG.A.

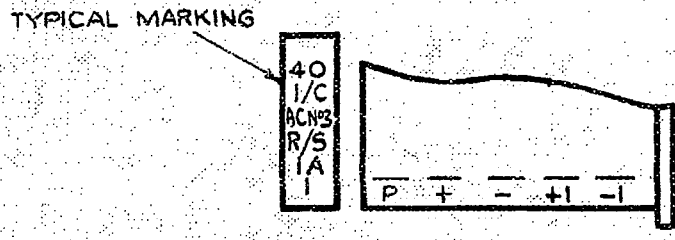
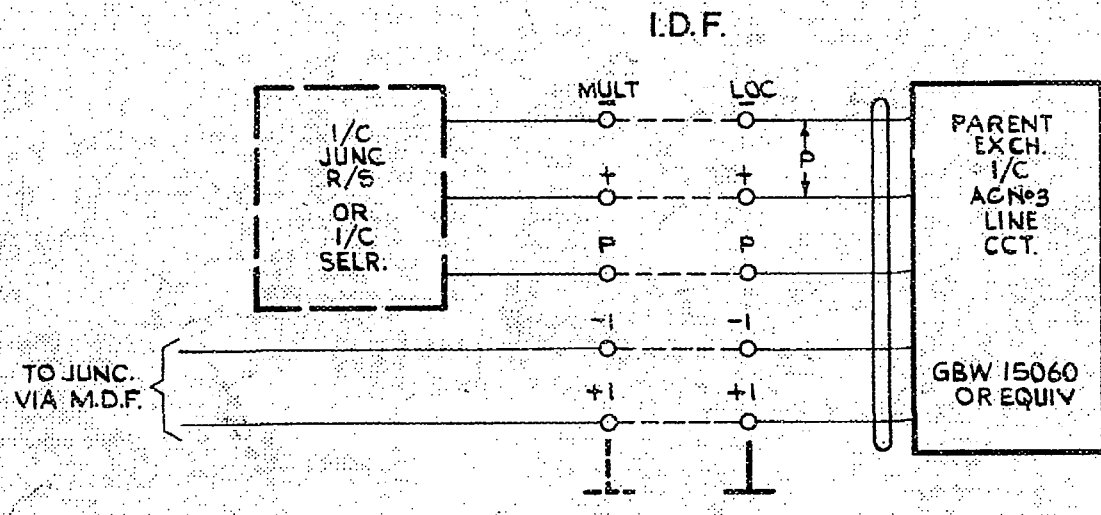

FIG.B.

				I/C LINE CIRCUIT N.Z.S.S. A.C. No 3. PARENT EXCHANGE FROM DEPENDENT EXCHANGE	
ISSUE ADVANCED NO CHANGE	(13734)	5	8-10-70	RW	
SHEET 3 ADDED	(13734)	4	8-10-70	RW	
TITLE AMENDED	(72212)	3	17-2-64	DBX	
SHEET 2 ADDED	(66585)	2	21-3-63	DBX	
	(35358)	1	10-11-60	DBX	
AMENDMENT PARTICULARS		ISSUE DATE	APPD		\$
				GBX 15060	
N.Z.P.O.	DRAWN B.A.	CHECKED B.A.	WIRING ASH	CIRCUIT	SHT 1-3

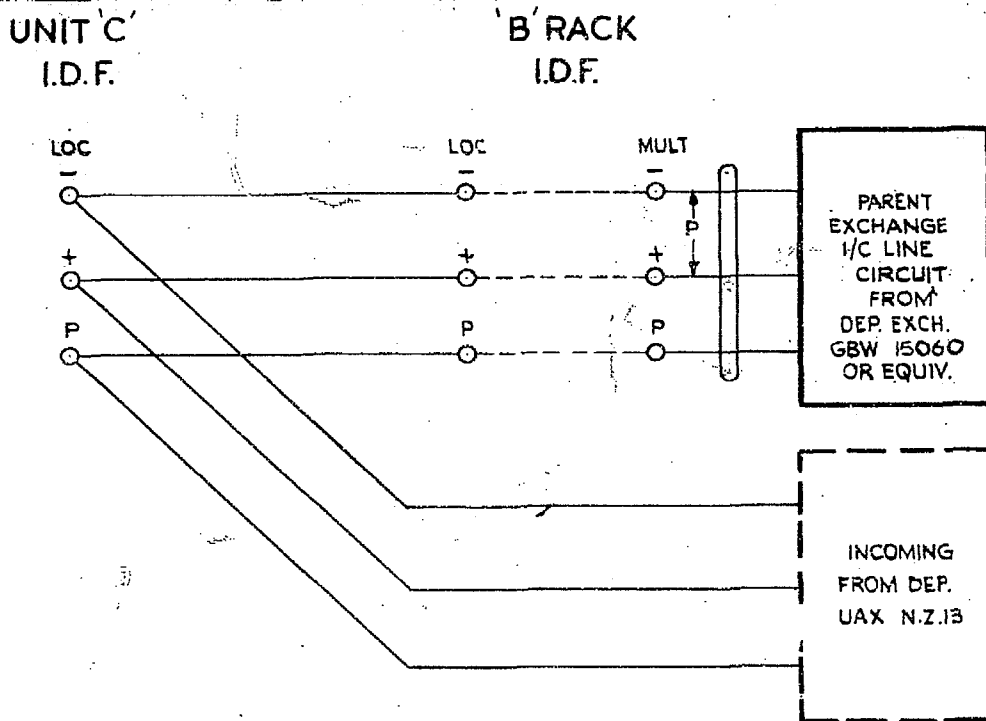

FIG. C. PARENT U.A.X. NZ 13. BOTHWAY WORKING.

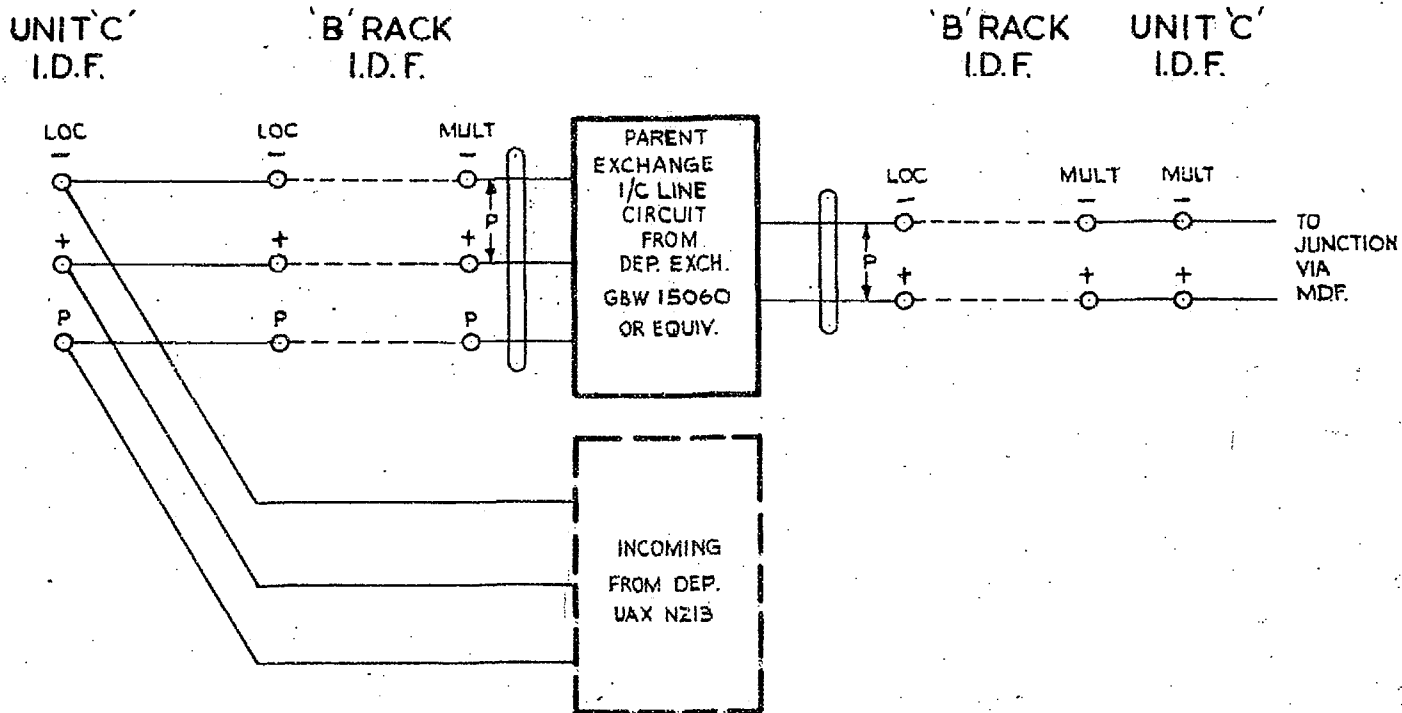
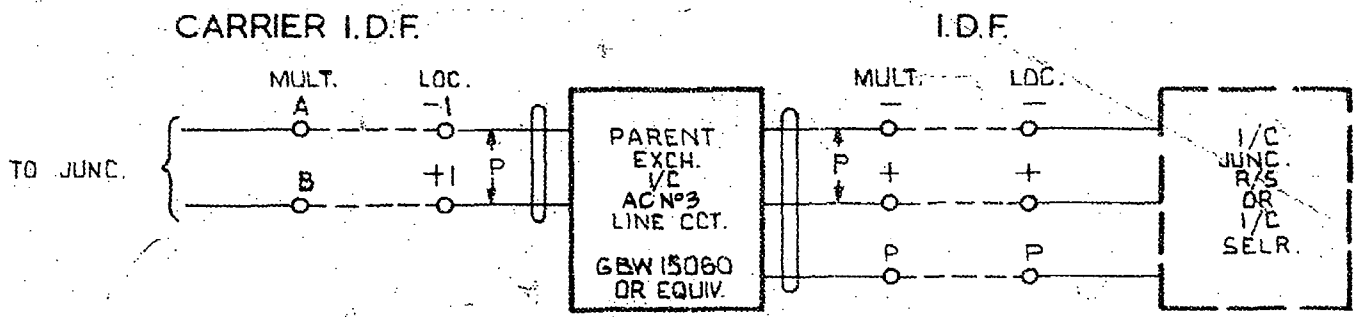
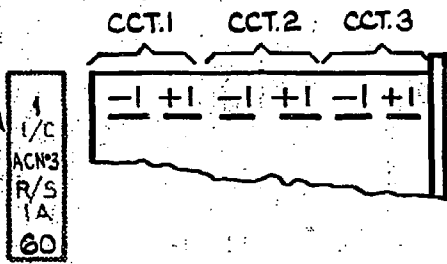

FIG. D. PARENT UAX. NZ13. UNI-DIRECTIONAL WORKING.

					1/C LINE CIRCUIT N.Z.S.S. A.C. N° 3 PARENT EXCHANGE FROM DEPENDENT EXCHANGE	
ISSUE ADVANCED NO CHANGE	(13734)	5	8-10-70	RW		
SHT.3 ADDED	(13734)	4	8-10-70	RW		
TITLE AMENDED	(72212)	3	17-2-64	DBK		
	(66585)	2	21-3-63	DBK		
AMENDMENT PARTICULARS				ISSUE	DATE	APP
						REF :- GBW 15780 FIGS.16&19
				GBX 15060		
N.Z.P.O.		DRAWN	CHECKED	WIRING	CIRCUIT	SHT.2-3



TYPICAL MARKING



TYPICAL MARKING

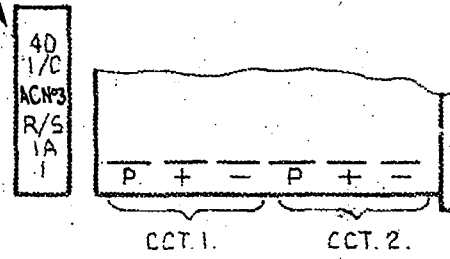

CARRIER I.D.F. LOC.

I.D.F. MULT.

FIG. E.

				I/C LINE CIRCUIT N.Z. S.S. AC. No 3 PARENT EXCHANGE FROM DEPENDENT EXCHANGE			
CARRIER I.D.F. BLK. VIEW INVERTED (13734)				5	8-10-70	RW	
(13734)				4	8-10-70	RW	
AMENDMENT PARTICULARS				ISSUE	DATE	APPD	
N.Z.P.O.				DRAWN LP	CHECKED <i>ble</i>	WIRING	CIRCUIT
GBX 15060						SHT. 3-3	