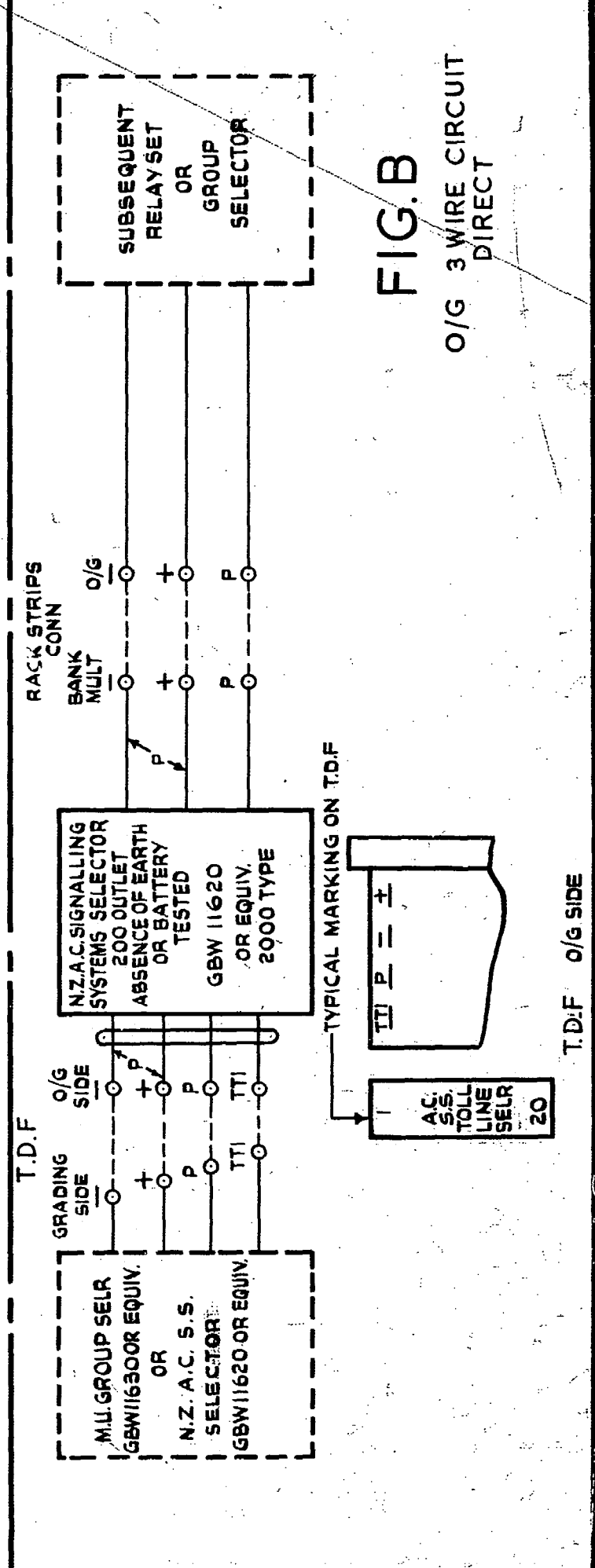


**FIG. A**  
O/G 3 WIRE CIRCUIT  
VIA I.D.F.

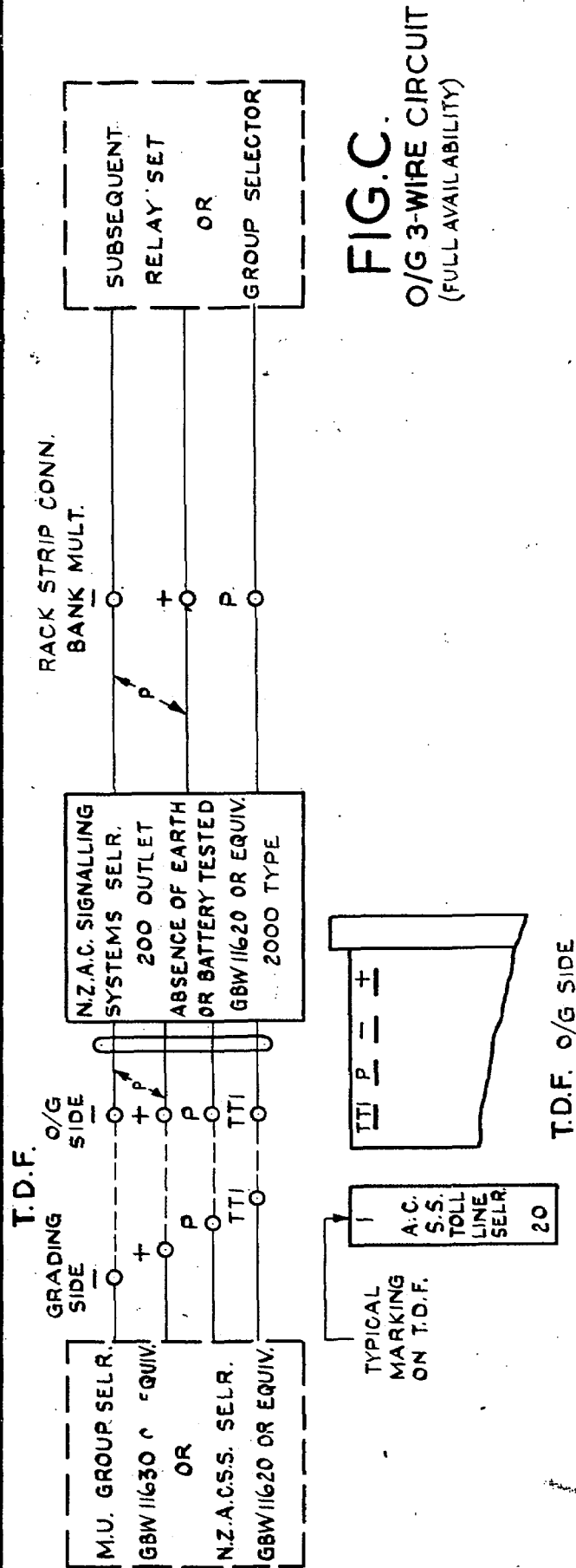
NOT TO BE USED  
FOR NEW WORK.



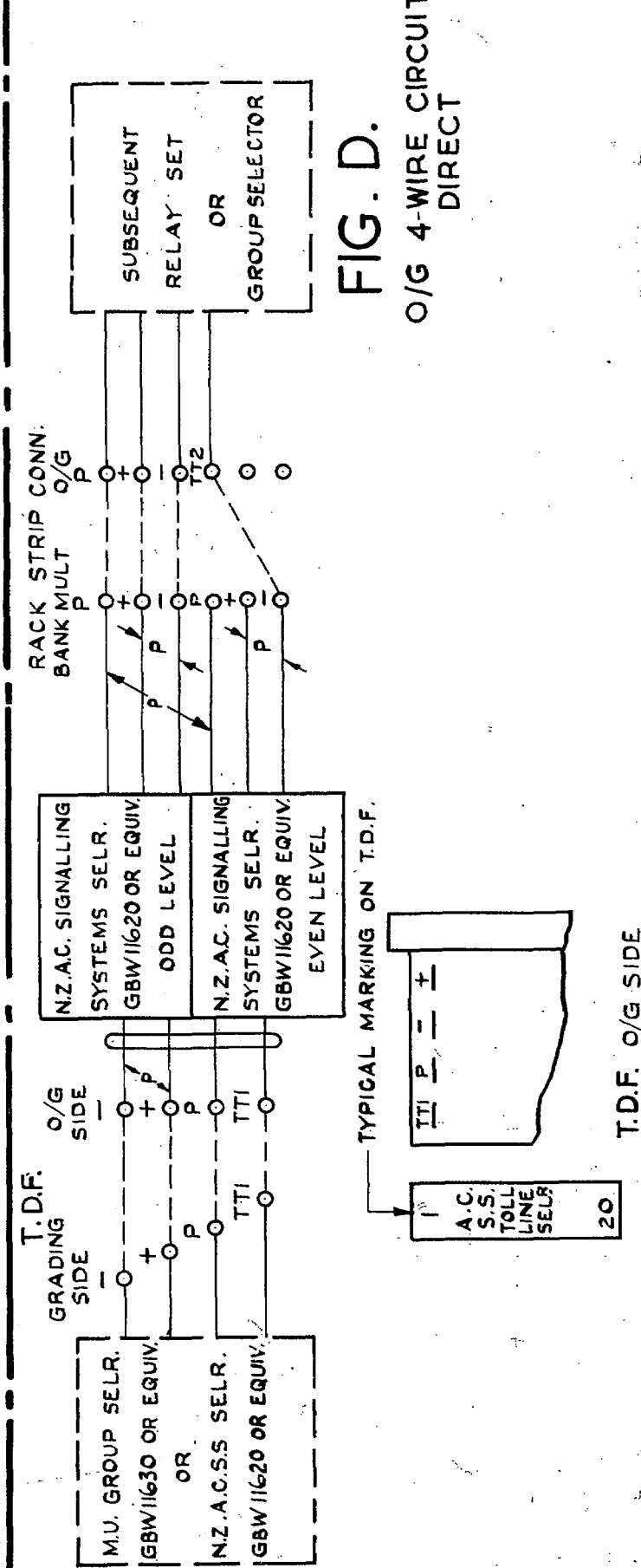
**FIG. B**  
O/G 3 WIRE CIRCUIT  
DIRECT

N.Z.A.C. SIGNALLING SYSTEMS SELECTOR 200 OUTLET (NOTE 2) ABSENCE OF EARTH OR BATTERY TESTED 2000 TYPE				
FIG. A. NOTE RE NEW WORK ADDED WAS SHT. 1-5 (9775)	5	17-6-68		
SHEETS 1,2&3 REDRAWN SHEETS 4&3 ADDED (72925)	4	21-5-64	DBH	
AMENDMENT PARTICULARS	ISSUE	DATE	APP.	REF. - VF
N.Z.P.O.	DRAWN	CHECKED	WIRING CIRCUIT	GBX 11620 11621
				SHT S.1-10

T.D.F. O/G SIDE

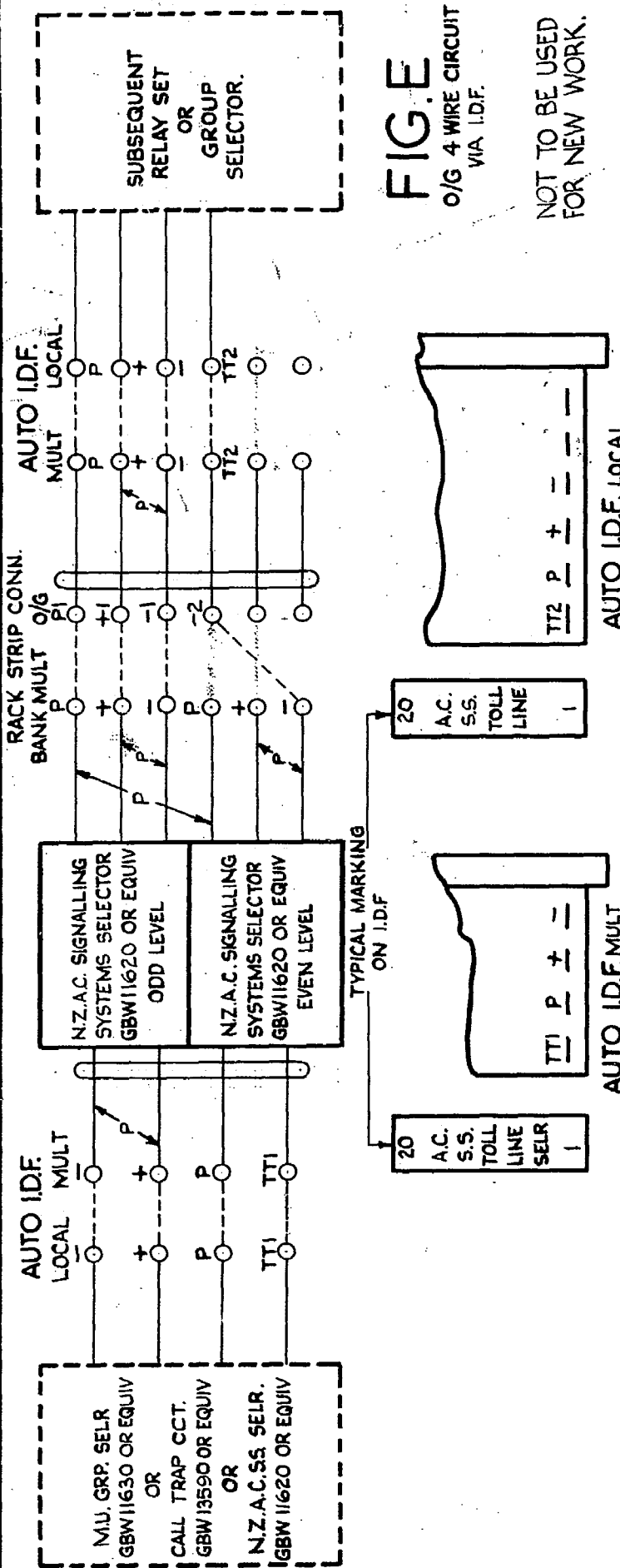


**FIG. C.**  
O/G 3-WIRE CIRCUIT  
(FULL AVAILABILITY)

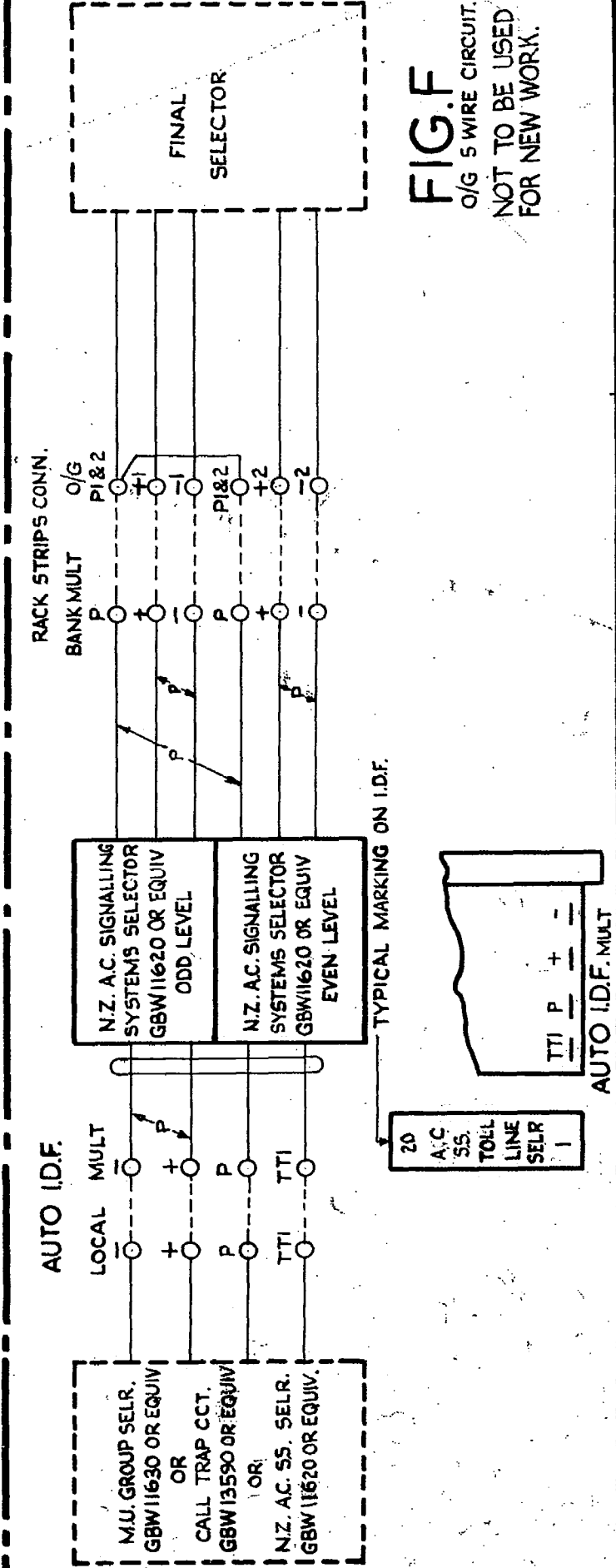


**FIG. D.**  
O/G 4-WIRE CIRCUIT  
DIRECT

					N.Z.A.C. SIGNALLING SYSTEMS SELECTOR 200 OUTLET (NOTE 2)	
					ABSENCE OF EARTH OR BATTERY TESTED 2000 TYPE	
NO AMENDMENT. SHEET 6-10 ADDED. (9775)			5	17-6-68		
SHTS. 1, 2, & 3 REDRAWN. SHTS. 4 & 5 ADDED (72925)			4	21-5-64	DBK	
AMENDMENT PARTICULARS			ISSUE	DATE	APP.	REF. - V.F.
N.Z.P.O.			DRAWN	CHECKED	WIRING	CIRCUIT
					<b>GBX 11620 11621</b>	
						SHT. 2-10



**FIG. E**  
O/G 4 WIRE CIRCUIT  
VIA I.D.F.  
NOT TO BE USED  
FOR NEW WORK.



**FIG. F**  
O/G 5 WIRE CIRCUIT.  
NOT TO BE USED  
FOR NEW WORK.

					N.Z. A.C. SIGNALLING SYSTEMS SELECTOR 200 OUTLET (NOTE 2)	
					ABSENCE OF EARTH OR BATTERY TESTED 2000 TYPE	
FIG. E & F NOTE RE NEW WORK ADDED: WAS SHEET 3-5 (9775)			5	17-6-68		
SHEETS 1, 2 & 3 REDRAWN. SHEETS 4 & 5 ADDED (72925)			4	21-5-64	DBK	
AMENDMENT PARTICULARS			ISSUE	DATE	APP.	REF. :- V.F.
N.Z. P.O.			DRAWN	CHECKED	WIRING	CIRCUIT
			<b>GBX 11620</b>		<b>11621</b>	
						SHEET 3:10

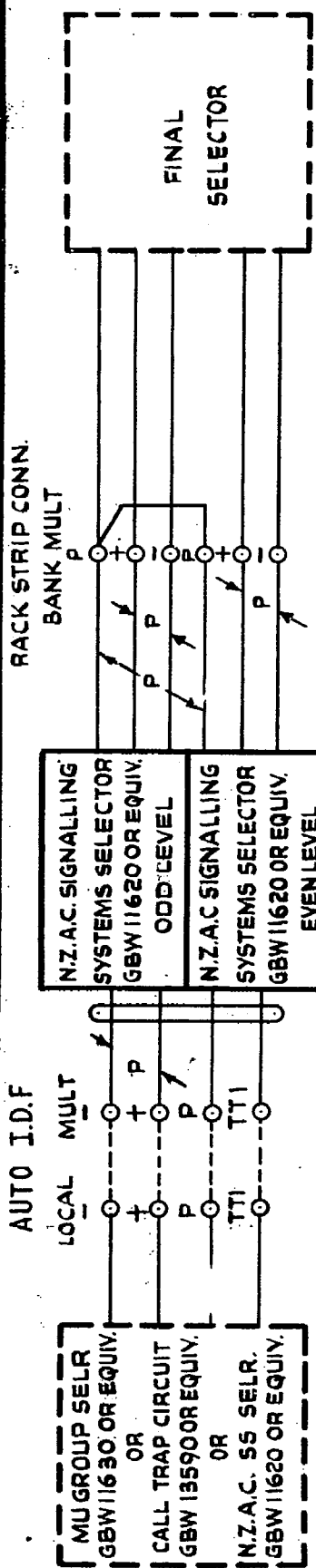


FIG. G

O/G 5 WIRE CIRCUIT  
(FULL AVAILABILITY)

NOT TO BE USED FOR NEW WORK.

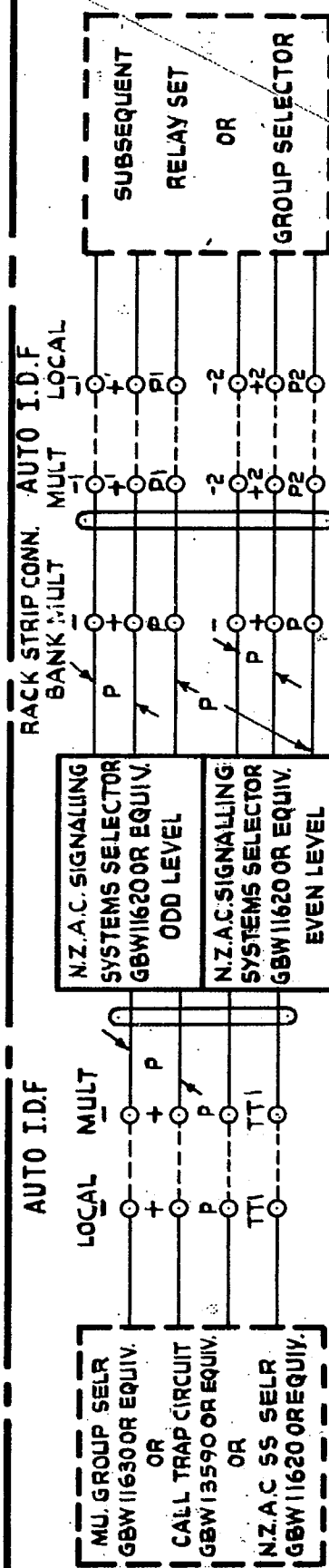


FIG. H

CENTRAL GRADING  
VIA I.D.F.

NOT TO BE USED  
FOR NEW WORK.

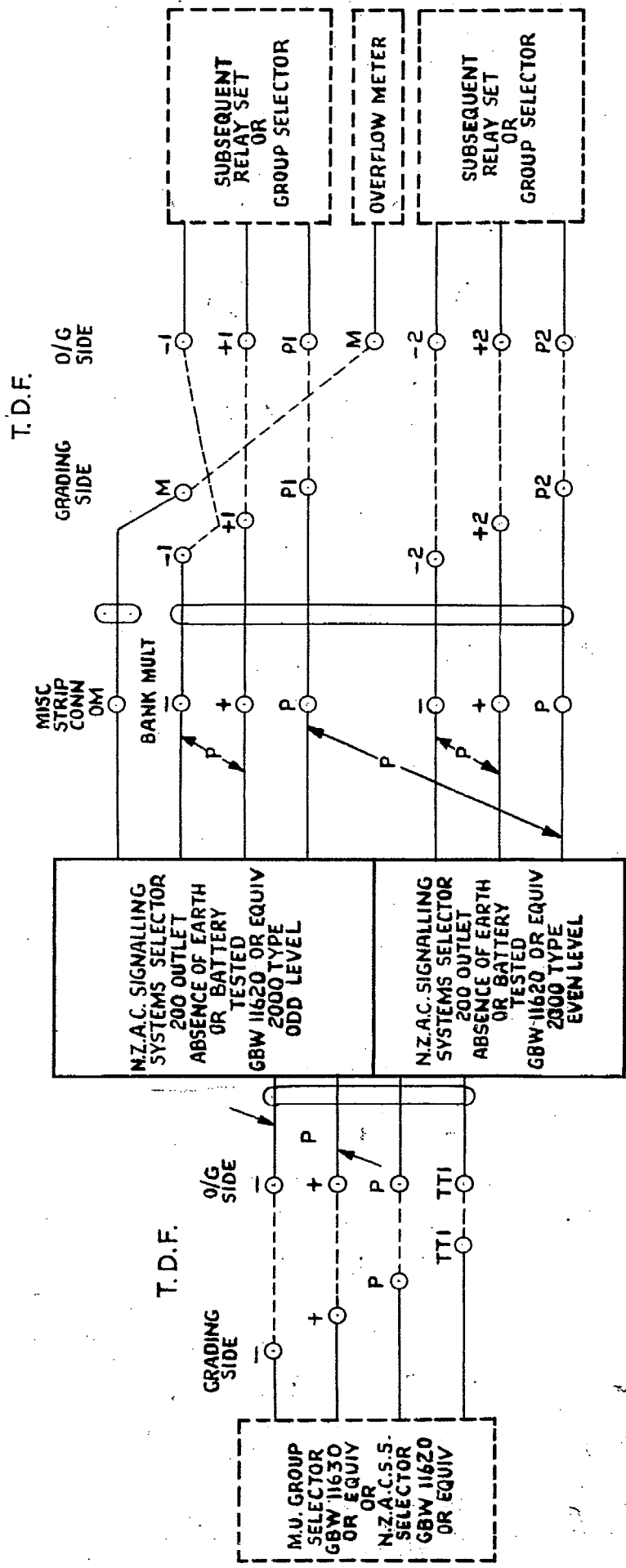
FIG. G & H. NOTE RE: NEW WORK ADDED. WAS SHT. 4-5 (9775)	5	17-6-63	
(72925)	4	21-5-64	DBX
AMENDMENT PARTICULARS	ISSUE	DATE	APP
N.Z.P.O.	DRAWN	CHECKED	WIRING CIRCUIT

N.Z.A.C. SIGNALLING  
SYSTEMS SELECTOR 200 OUTLET  
(NOTE 2)  
ABSENCE OF EARTH OR BATTERY TESTED  
2000 TYPE

REF: -VF

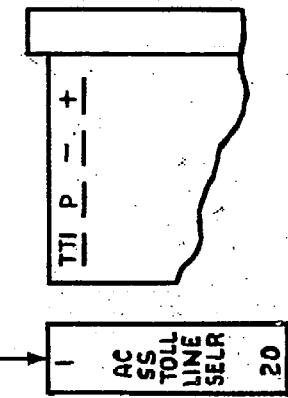
GBX 11620  
11621

SHT. 4-10



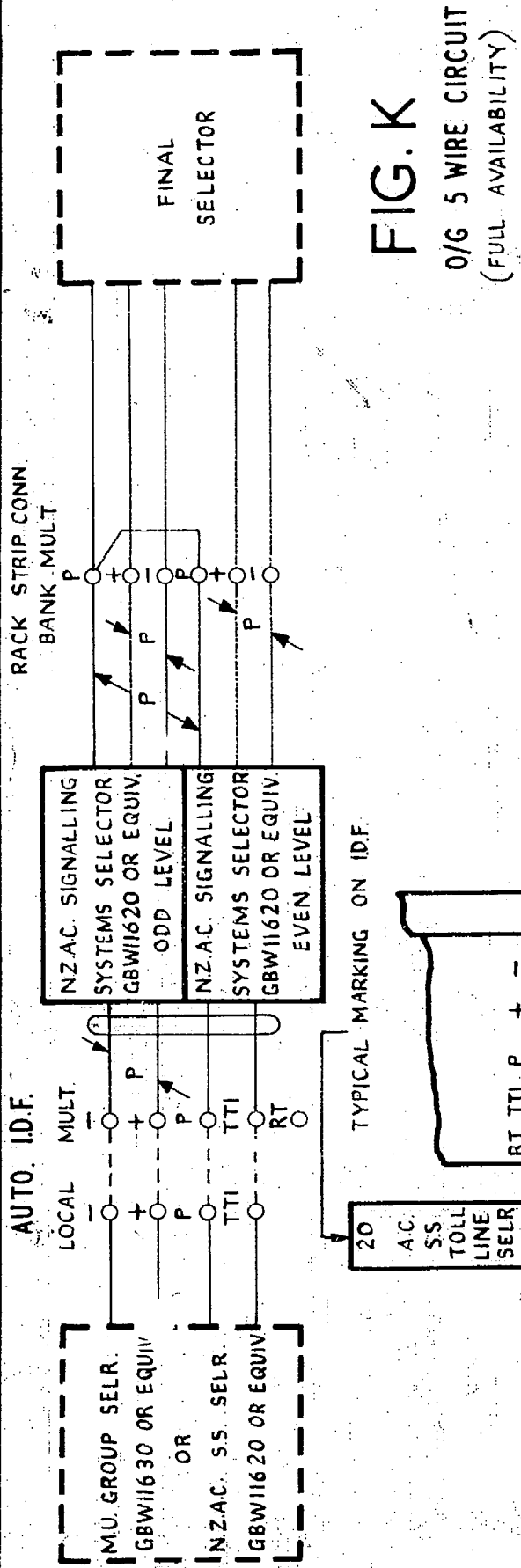
**FIG. J**  
CENTRAL GRADING  
VIA T.D.F.

TYPICAL MARKING ON T.D.F.

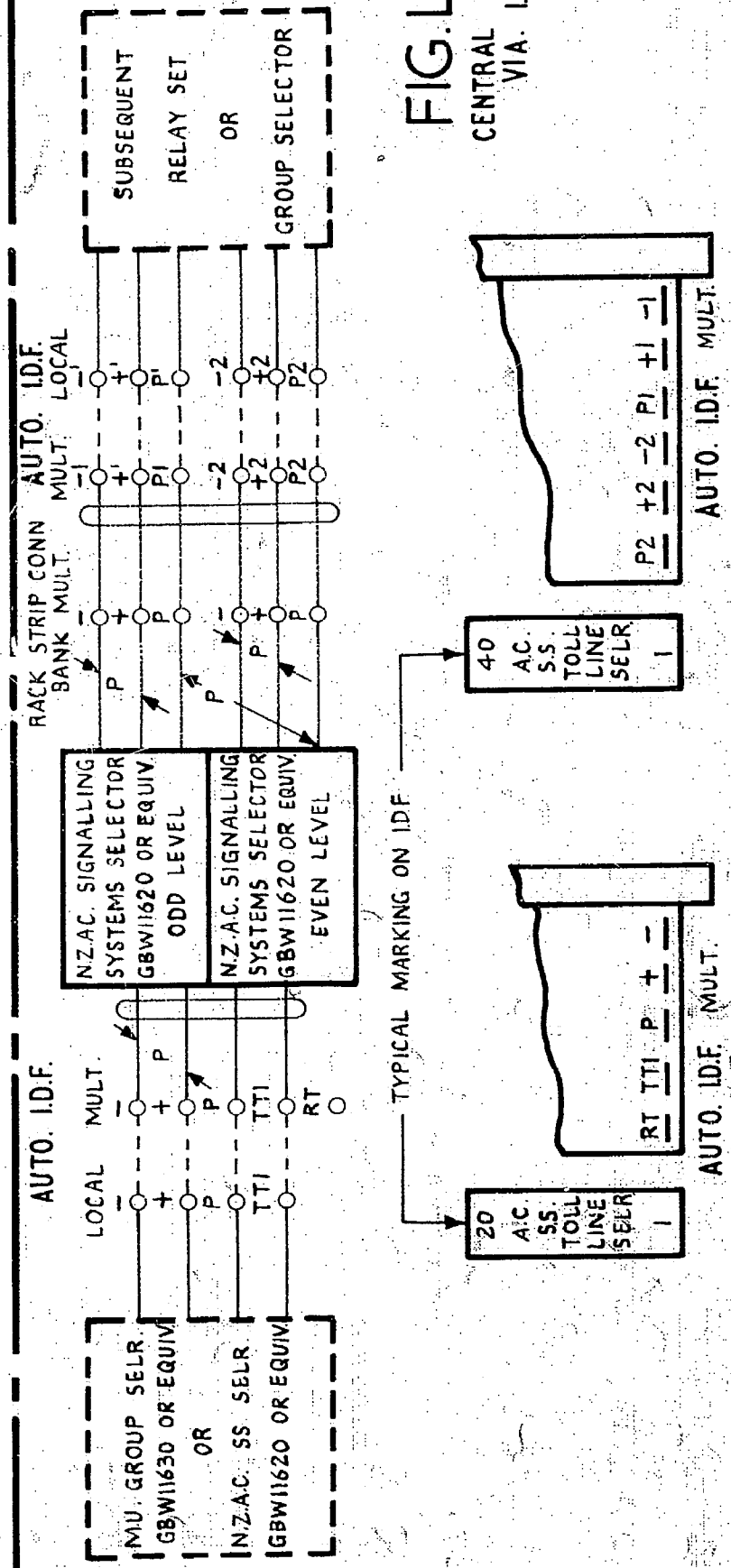


T.D.F. o/g SIDE

				<b>N.Z.A.C. SIGNALLING SYSTEMS SELECTOR 200 OUTLET (NOTE 2)</b>	
				<b>ABSENCE OF EARTH OR BATTERY TESTED 2000 TYPE</b>	
NO AMENDMENT SHEETS 6-10 ADDED (9775)		5	17-6-68	<b>REF - VF</b>	
(72925)		4	21-5-64		
<b>AMENDMENT PARTICULARS</b>		ISSUE	DATE	APP	<b>S</b>
N.Z.P.O.		DRAWN	CHECKED	WIRING	CIRCUIT
				<b>GBX 11620 11621</b>	
				SHEET 5-10	



**FIG. K**  
0/G 5 WIRE CIRCUIT  
(FULL AVAILABILITY)



**FIG. L**  
CENTRAL GRADING  
VIA. I.D.F.

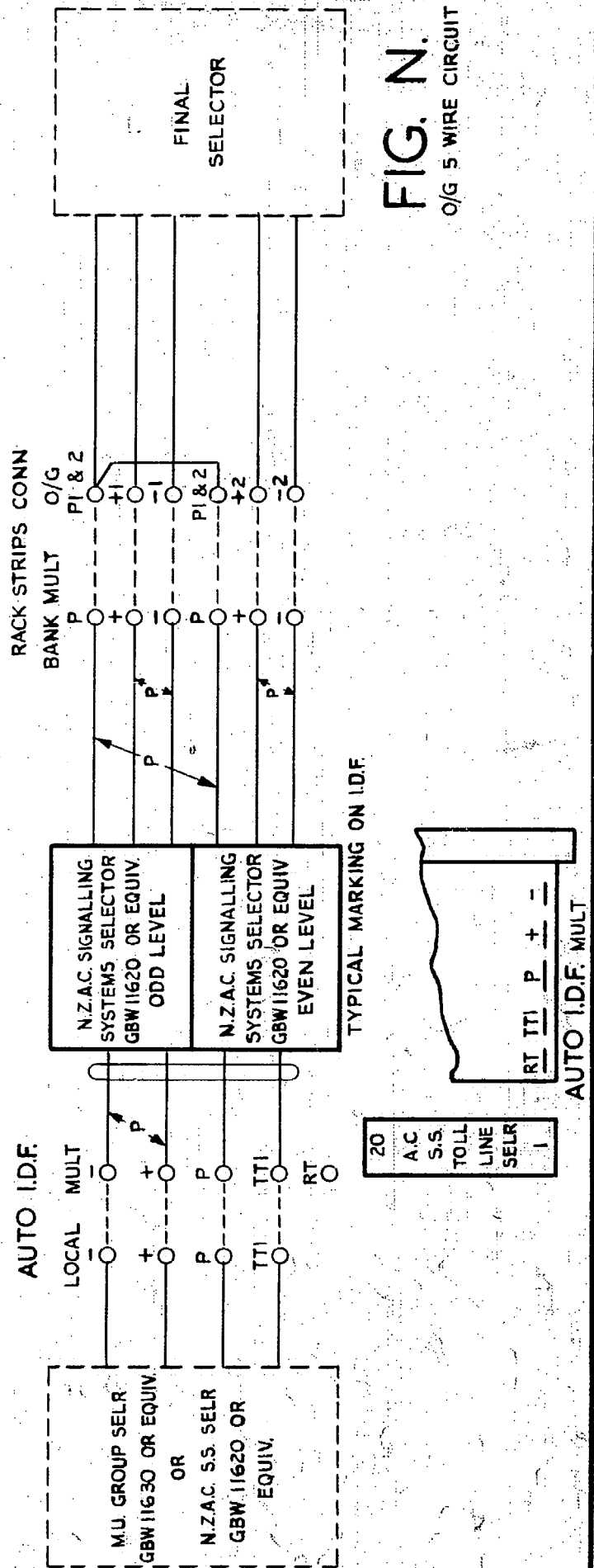
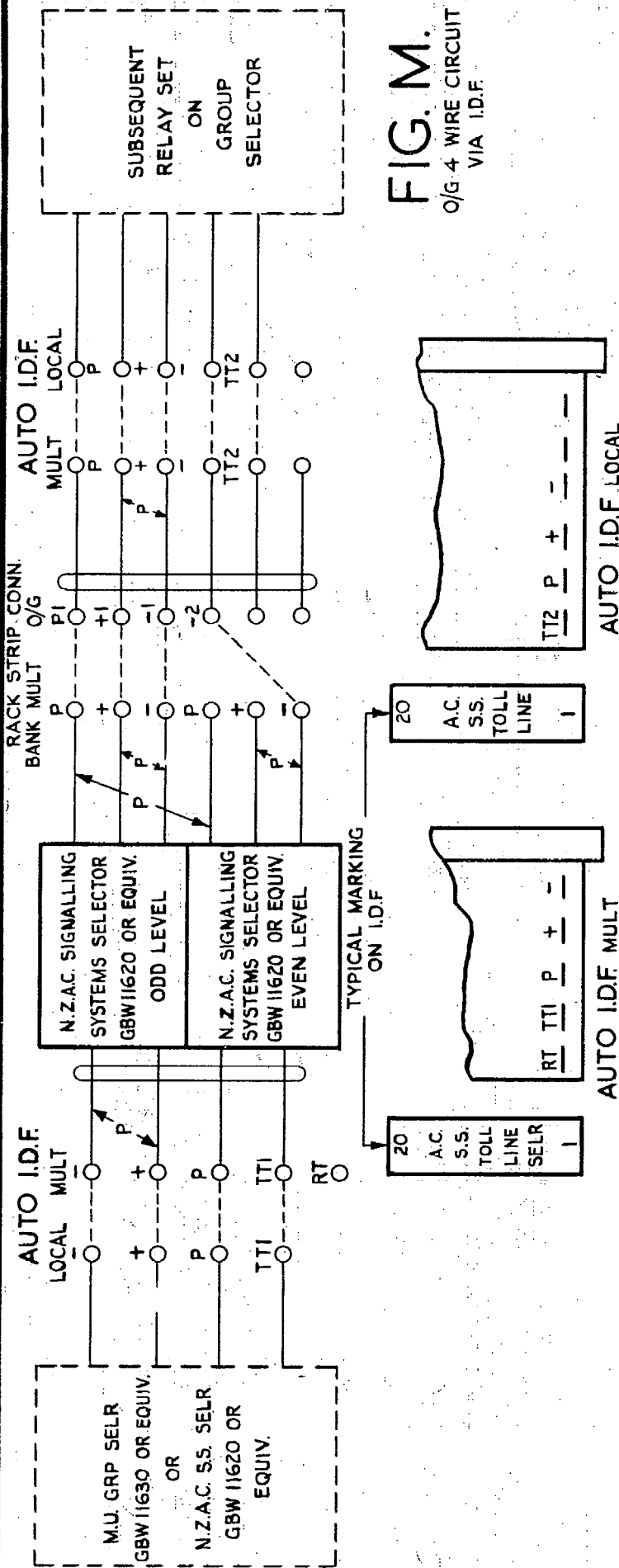
N.Z.P.O.	DRAWN MH	CHECKED MH	WIRING	CIRCUIT ASH
AMENDMENT PARTICULARS		ISSUE	DATE	APP
(9775)		5	17-6-68	

N.Z.A.C. SIGNALLING  
SYSTEMS SELECTOR 200 OUTLET  
(NOTE 2)  
ABSENCE OF EARTH OR BATTERY TESTED  
2000 TYPE

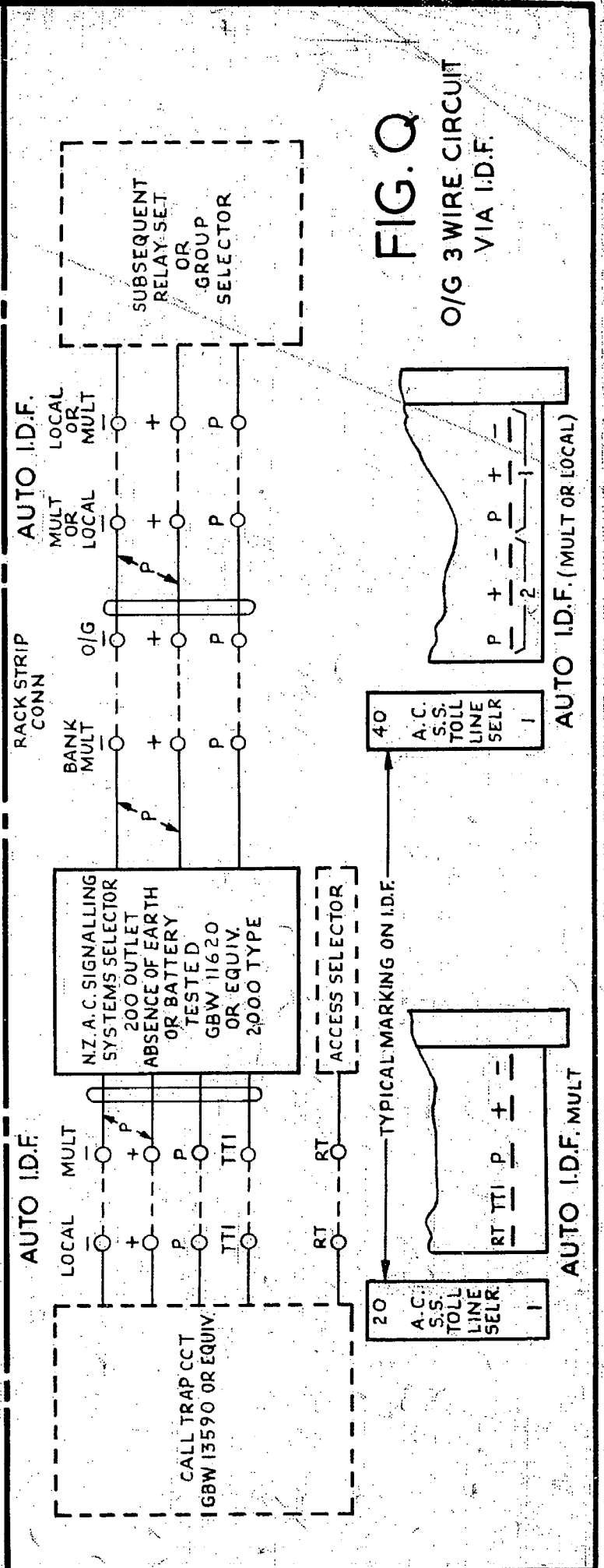
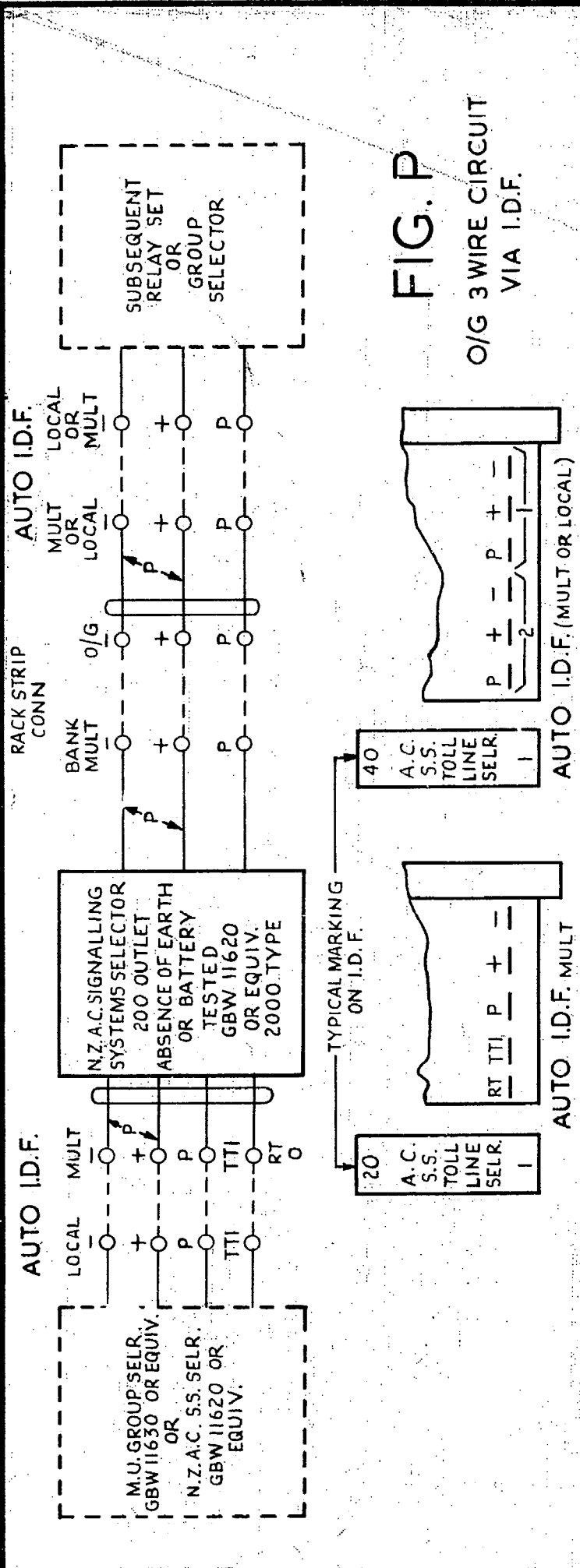
REF - VF

**GBX 11620**  
**11621**

SHT.6-10

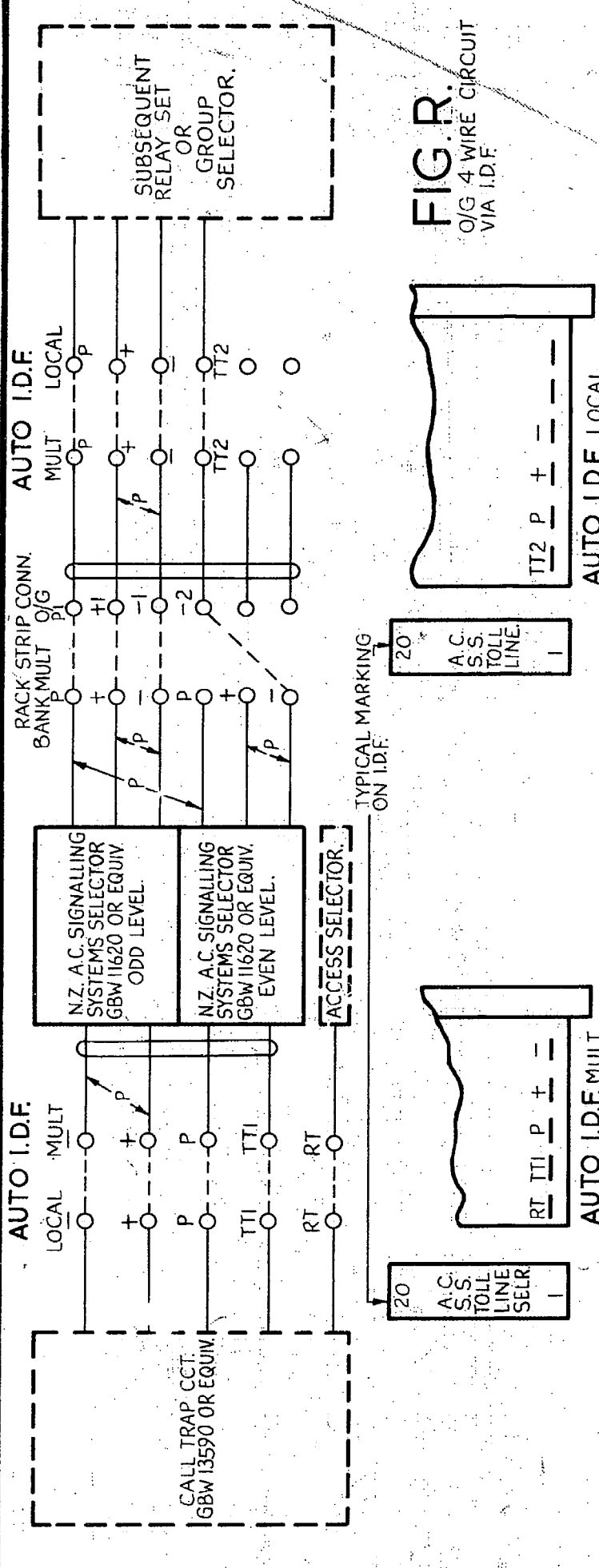


				N.Z.A.C. SIGNALLING SYSTEMS SELECTOR 200 OUTLET (NOTE 2)	
				ABSENCE OF EARTH OR BATTERY TESTED 2000 TYPE	
AMENDMENT PARTICULARS		ISSUE	DATE	APP	REF. - VF.
		5	17.6.68		S
N.Z.P.O.		DRAWN	CHECKED	WIRING	CIRCUIT
		MH	MH	GH	GH
				GBX 11620 11621	
				SHEET 7-10	

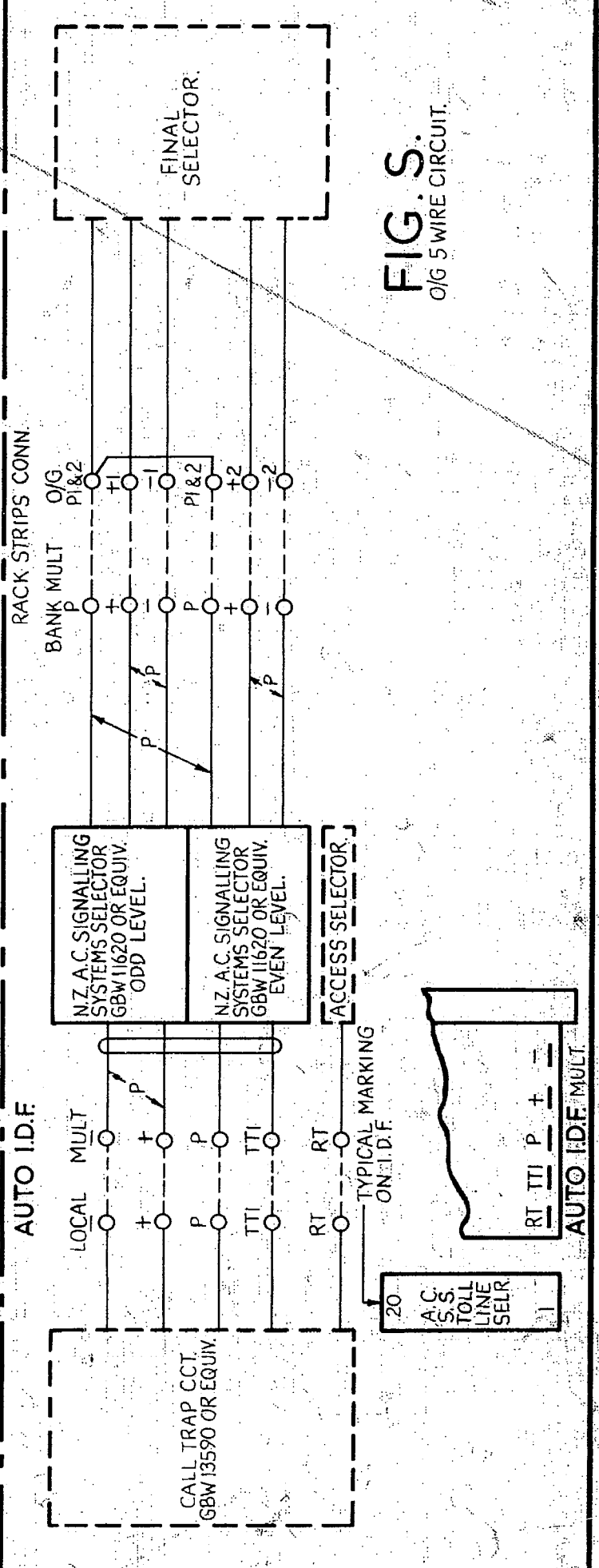


					N.Z.A.C. SIGNALLING SYSTEMS SELECTOR 200 OUTLET (NOTE 2) ABSENCE OF EARTH OR BATTERY TESTED 2000 TYPE	
		(9775)	5	17/6/68	SE	
AMENDMENT PARTICULARS			ISSUE	DATE	APP.	REF. - VF
N.Z.P.O.	DRAWN MH	CHECKED MH	WIRING	CIRCUIT	<b>GBX 11620 11621</b>	
						SHTS. 8-10





**FIG. R.**  
O/G 4 WIRE CIRCUIT  
VIA I.D.F.



**FIG. S.**  
O/G 5 WIRE CIRCUIT.

N.Z.P.O.	DRAWN MH	CHECKED MH	WIRING	CIRCUIT
AMENDMENT PARTICULARS		ISSUE	DATE	APP
(9775)		5	17-6-68	<i>[Signature]</i>

N.Z. A.C. SIGNALLING  
SYSTEMS SELECTOR 200 OUTLET  
(NOTE 2)  
ABSENCE OF EARTH OR BATTERY TESTED  
2000 TYPE

REF -V.F. S

**GBX 11620  
11621**

SHEET. 9-10

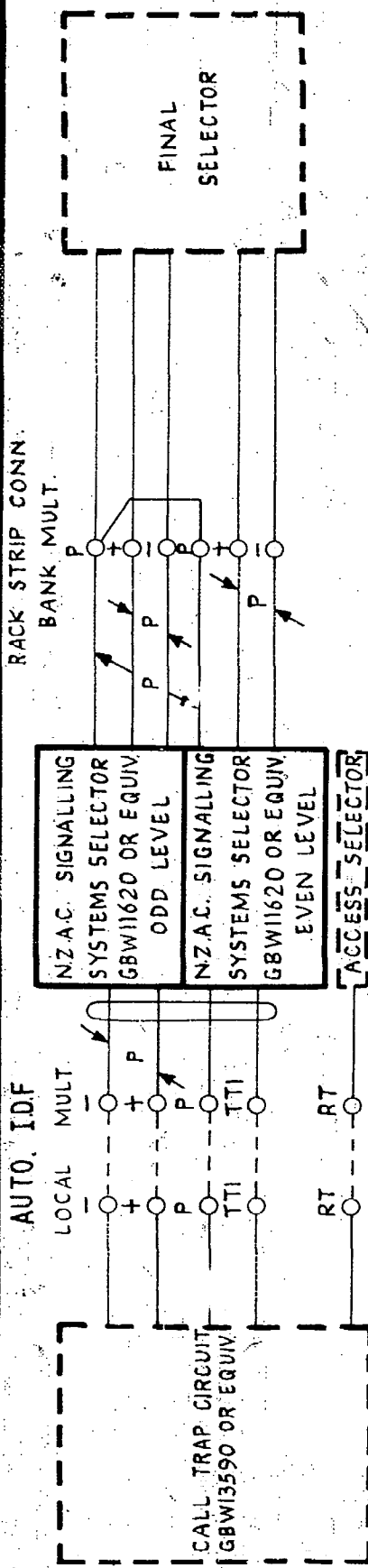


FIG. T  
O/G 5 WIRE CIRCUIT  
(FULL AVAILABILITY)

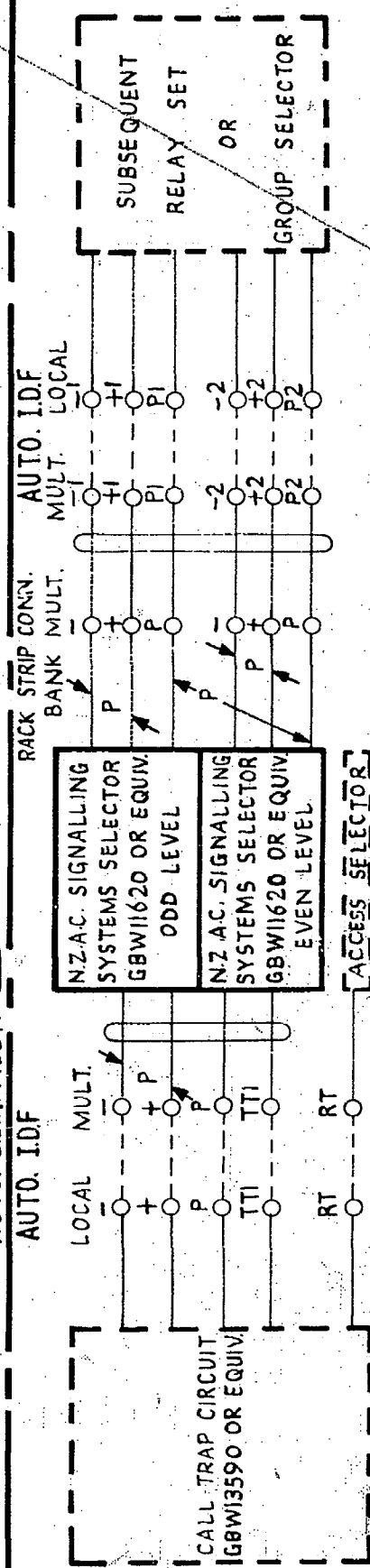


FIG. U  
CENTRAL GRADING  
VIA. IDF

NZ.P.O.	DR. AWN MH	CHECKED MH	WIRING CIRCUIT	APP.	REF - VF	S
AMENDMENT PARTICULARS			ISSUE	DATE		
(9775)			5	17.6.68		

N.Z.A.C. SIGNALLING  
SYSTEMS SELECTOR 200 OUTLET  
(NOTE 2)  
ABSENCE OF EARTH OR BATTERY TESTED  
2000 TYPE

GBX 11620  
11621

SHT 10 - 10