

FIG. A
O/G 3 WIRE CIRCUIT
VIA I.D.F.

NOT TO BE USED
FOR NEW WORK.

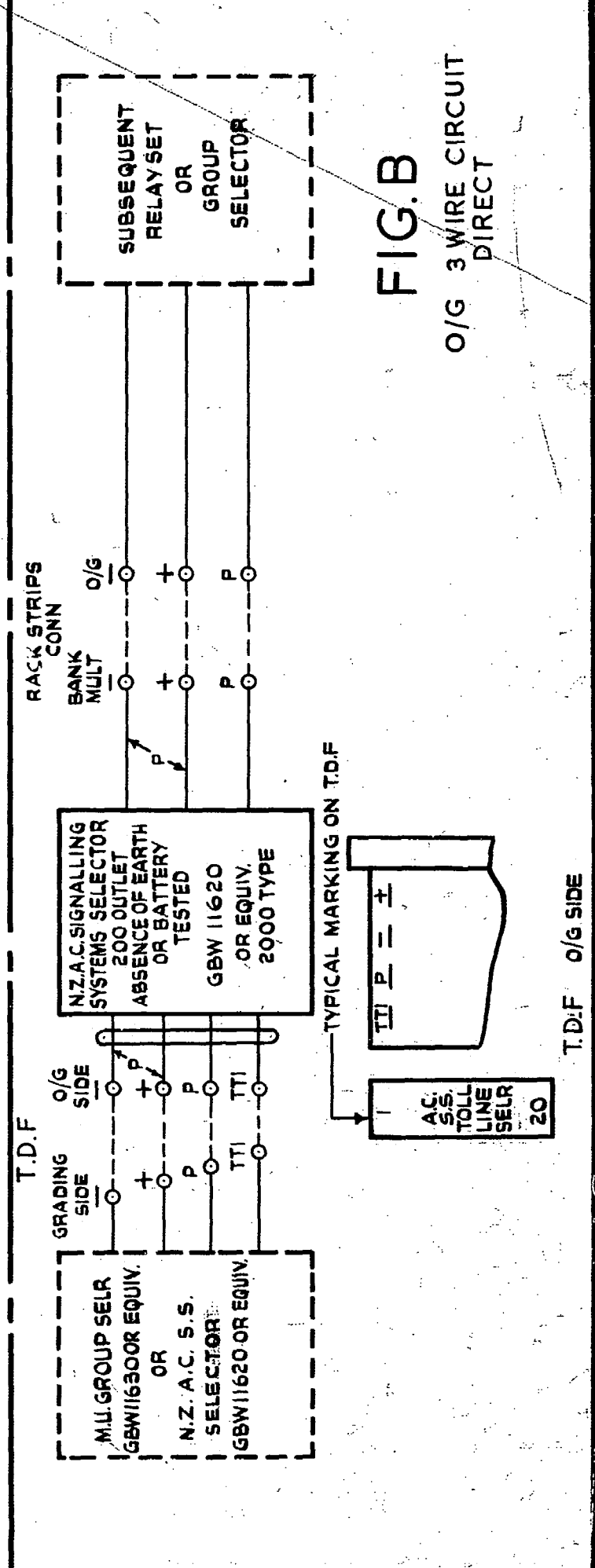

FIG. B
O/G 3 WIRE CIRCUIT
DIRECT

N.Z.A.C. SIGNALLING SYSTEMS SELECTOR 200 OUTLET (NOTE 2) ABSENCE OF EARTH OR BATTERY TESTED 2000 TYPE				
FIG. A. NOTE RE NEW WORK ADDED WAS SHT. 1-5 (9775)	5	17-6-68		
SHEETS 1,2&3 REDRAWN SHEETS 4&3 ADDED (72925)	4	21-5-64	DBH	
AMENDMENT PARTICULARS	ISSUE	DATE	APP.	REF. - VF
N.Z.P.O.	DRAWN	CHECKED	WIRING CIRCUIT	GBX 11620 11621
				SHTS. 1-10

T.D.F. O/G SIDE

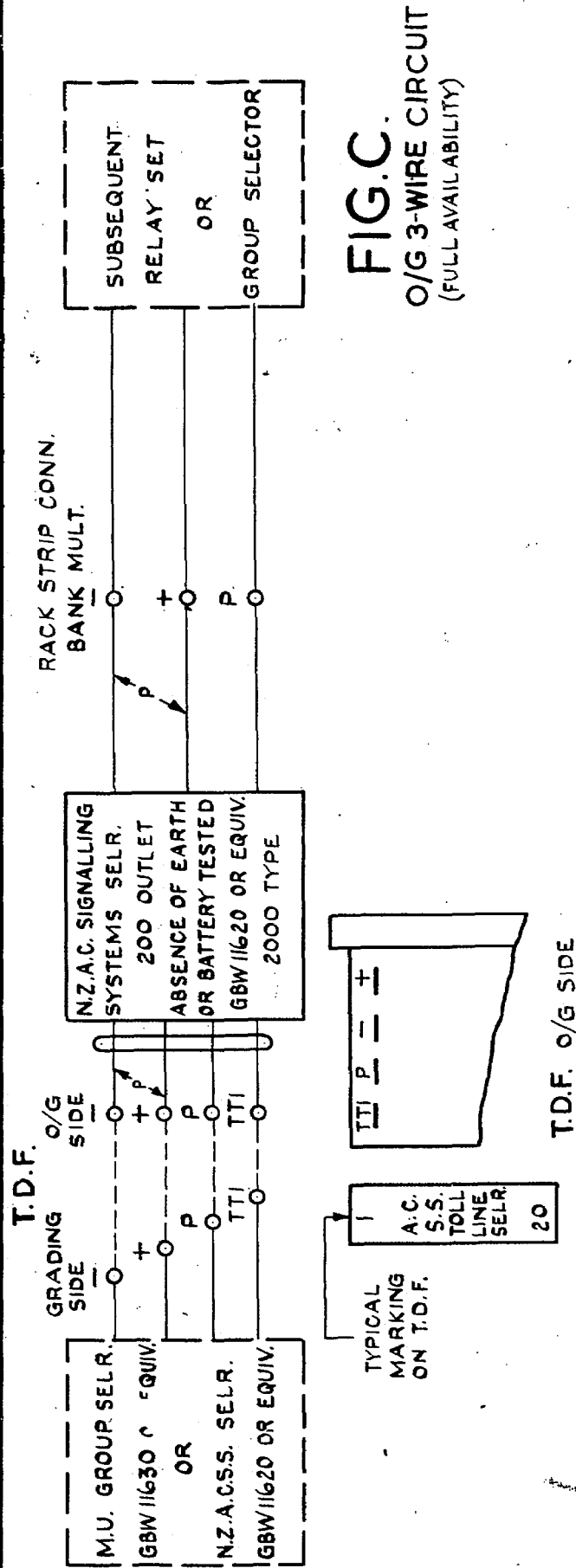

FIG. C.
O/G 3-WIRE CIRCUIT
(FULL AVAILABILITY)

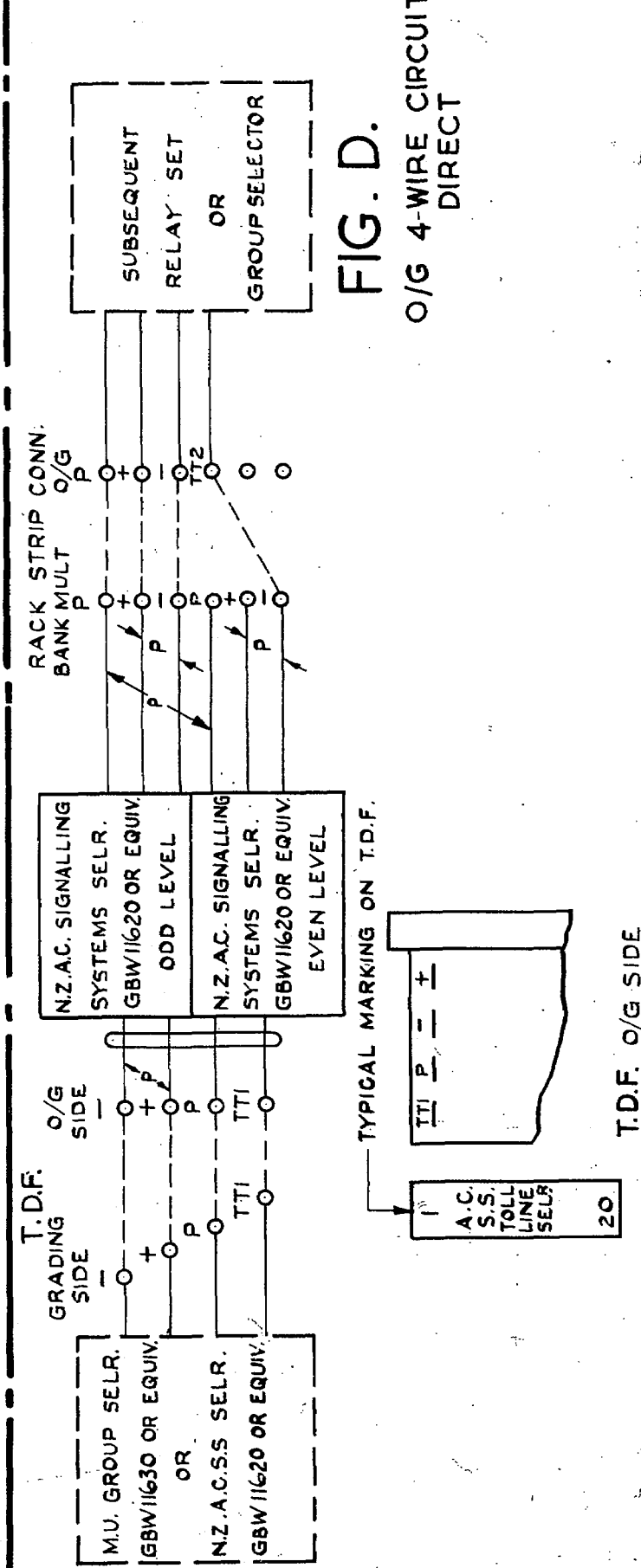

FIG. D.
O/G 4-WIRE CIRCUIT
DIRECT

				N. Z. A. C. SIGNALLING SYSTEMS SELECTOR 200 OUTLET (NOTE 2)	
				ABSENCE OF EARTH OR BATTERY TESTED 2000 TYPE	
NO AMENDMENT. SHEET 6-10 ADDED. (9775)		5	17-6-68		
SHTS. 1, 2, & 3 REDRAWN. SHTS. 4 & 5 ADDED (72925)		4	21-5-64	DBK	
AMENDMENT PARTICULARS		ISSUE	DATE	APP.	REF. - V.F.
N.Z.P.O.		DRAWN	CHECKED	WIRING	CIRCUIT
				GBX 11620 11621	
					SHT. 2-10

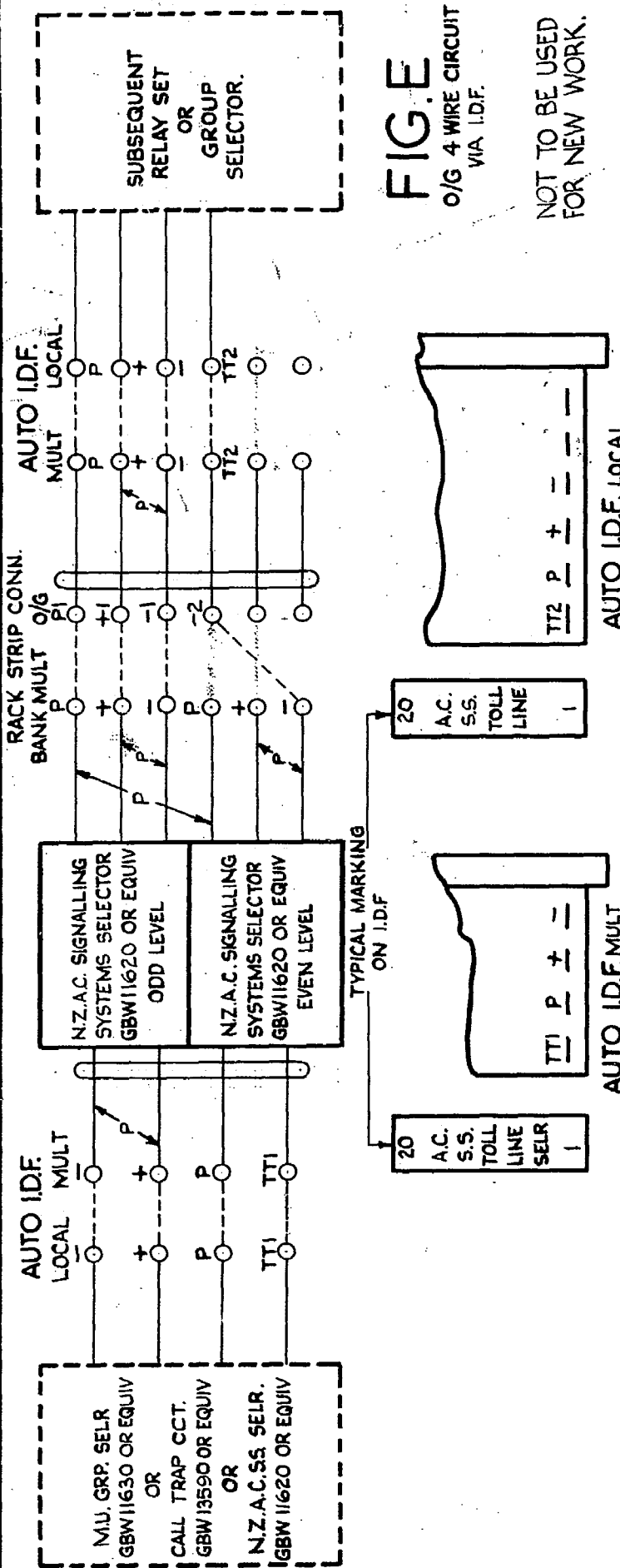

FIG. E
O/G 4 WIRE CIRCUIT
VIA I.D.F.
NOT TO BE USED
FOR NEW WORK.

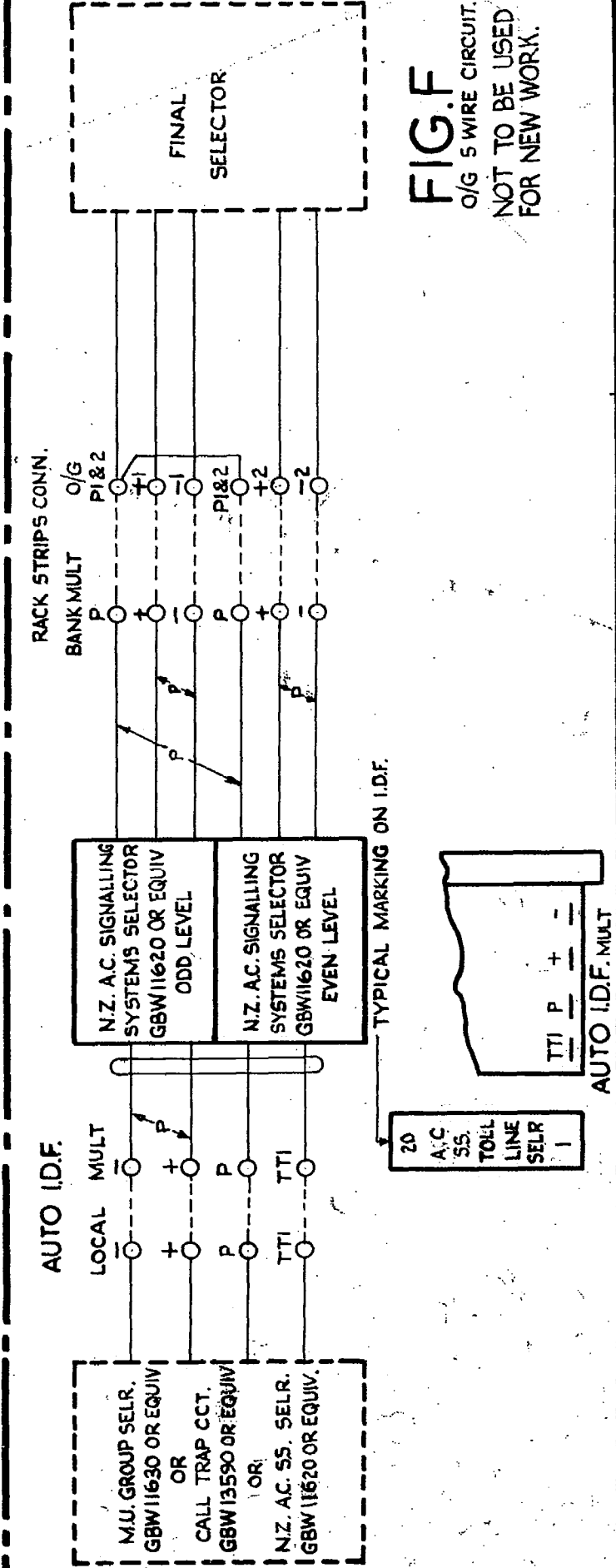

FIG. F
O/G 5 WIRE CIRCUIT.
NOT TO BE USED
FOR NEW WORK.

					N.Z. A.C. SIGNALLING SYSTEMS SELECTOR 200 OUTLET (NOTE 2)	
					ABSENCE OF EARTH OR BATTERY TESTED 2000 TYPE	
FIG. E & F NOTE RE NEW WORK ADDED: WAS SHEET 3-5 (9775)			5	17-6-68		
SHEETS 1, 2 & 3 REDRAWN. SHEETS 4 & 5 ADDED (72925)			4	21-5-64	DBK	
AMENDMENT PARTICULARS			ISSUE	DATE	APP.	REF. :- V.F.
N.Z. P.O.			DRAWN	CHECKED	WIRING	CIRCUIT
			GBX 11620		11621	
						SHEET 3:10

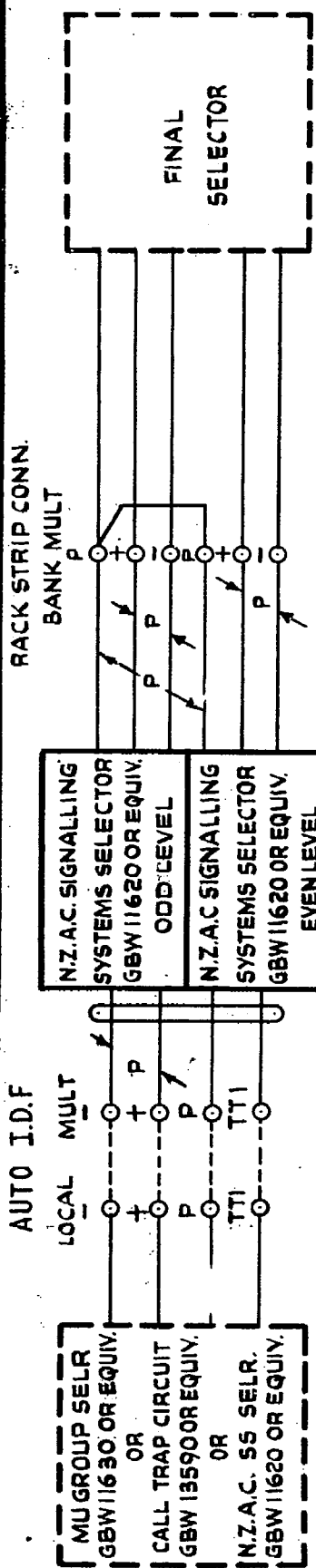

FIG. G

O/G 5 WIRE CIRCUIT
(FULL AVAILABILITY)

NOT TO BE USED FOR NEW WORK.

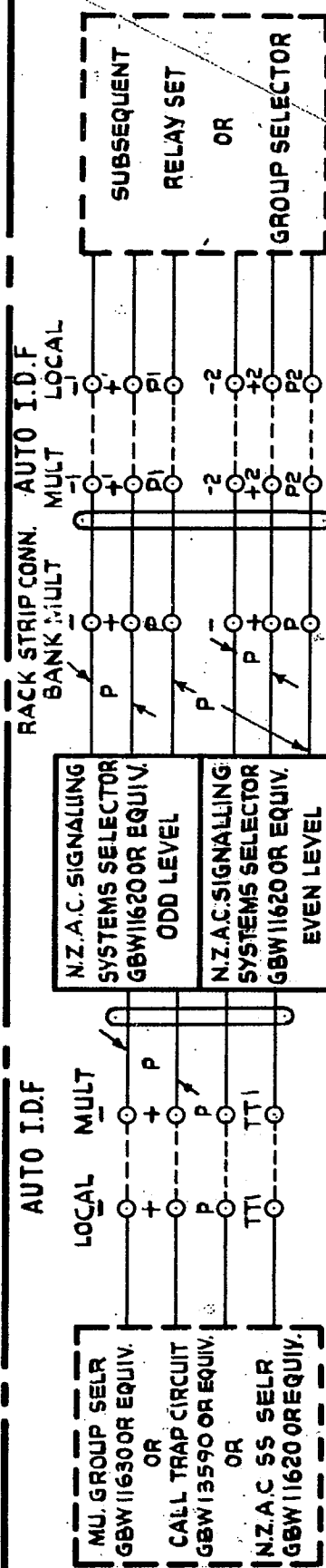

FIG. H

CENTRAL GRADING
VIA I.D.F.

NOT TO BE USED
FOR NEW WORK.

				N.Z.A.C. SIGNALLING SYSTEMS SELECTOR 200 OUTLET (NOTE 2)	
				ABSENCE OF EARTH OR BATTERY TESTED 2000 TYPE	
FIG. G & H. NOTE RE: NEW WORK ADDED. WAS SHT. 4-5 (9775)		5	17-6-63		
(72925)		4	21-5-64	DBX	
AMENDMENT PARTICULARS		ISSUE	DATE	APP	REF: -VF
N.Z.P.O.		DRAWN	CHECKED	WIRING	CIRCUIT
				GBX 11620 11621	
					SHT. 4-10

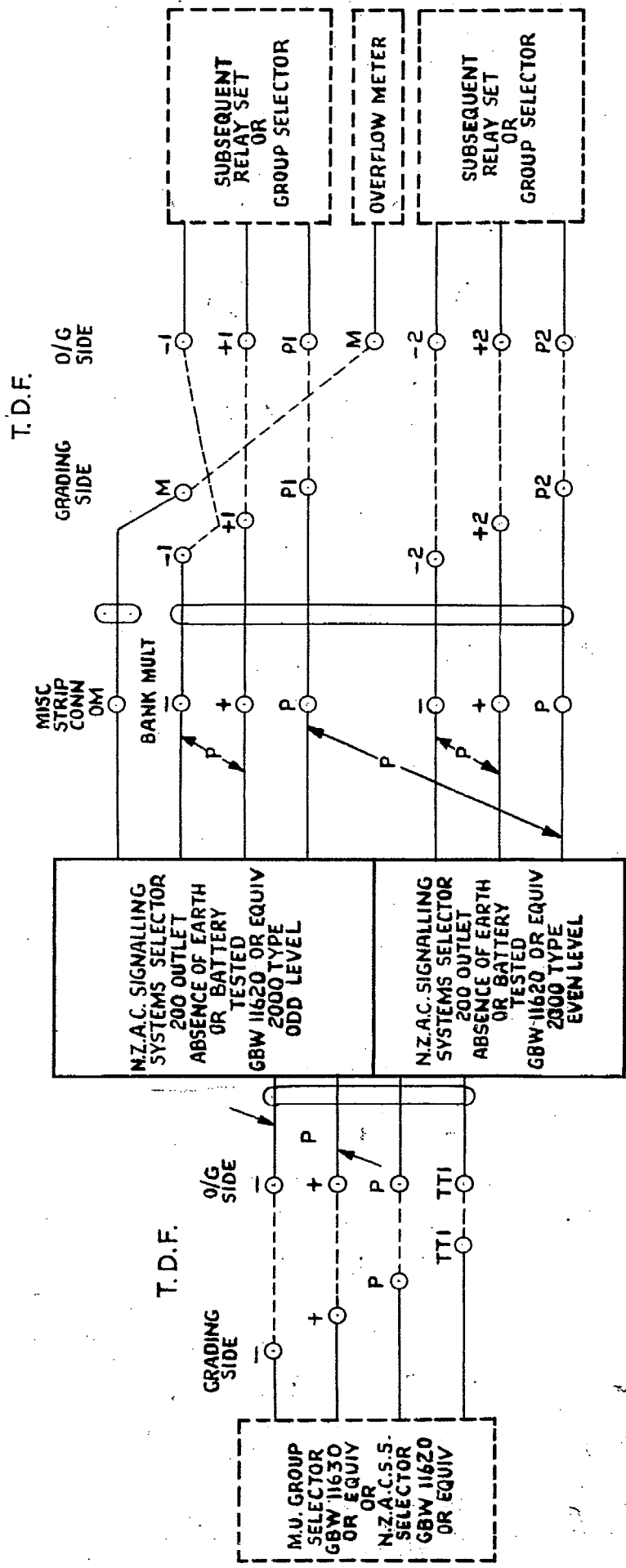
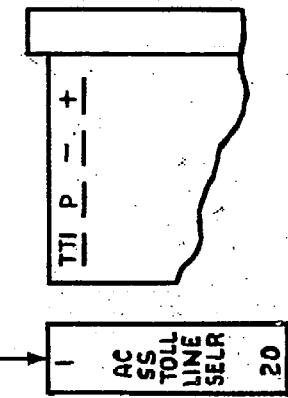

FIG. J
CENTRAL GRADING
VIA T.D.F.

TYPICAL MARKING ON T.D.F.



T.D.F. o/g SIDE

				N.Z.A.C. SIGNALLING SYSTEMS SELECTOR 200 OUTLET (NOTE 2)	
				ABSENCE OF EARTH OR BATTERY TESTED 2000 TYPE	
NO AMENDMENT SHEETS 6-10 ADDED (9775)		5	17-6-68		
(72925)		4	21-5-64		
AMENDMENT PARTICULARS		ISSUE	DATE	APP	REF - VF
N.Z.P.O.		DRAWN	CHECKED	WIRING	CIRCUIT
				GBX 11620 11621	
				SHEET 5-10	

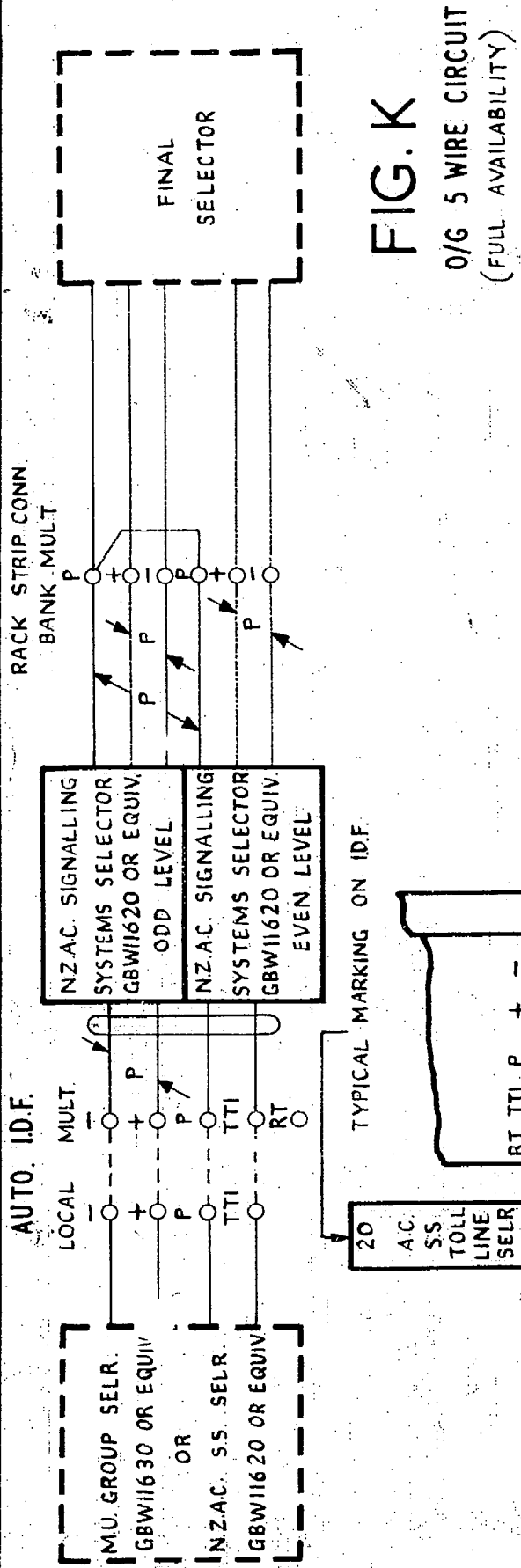

FIG. K

0/G 5 WIRE CIRCUIT
(FULL AVAILABILITY)

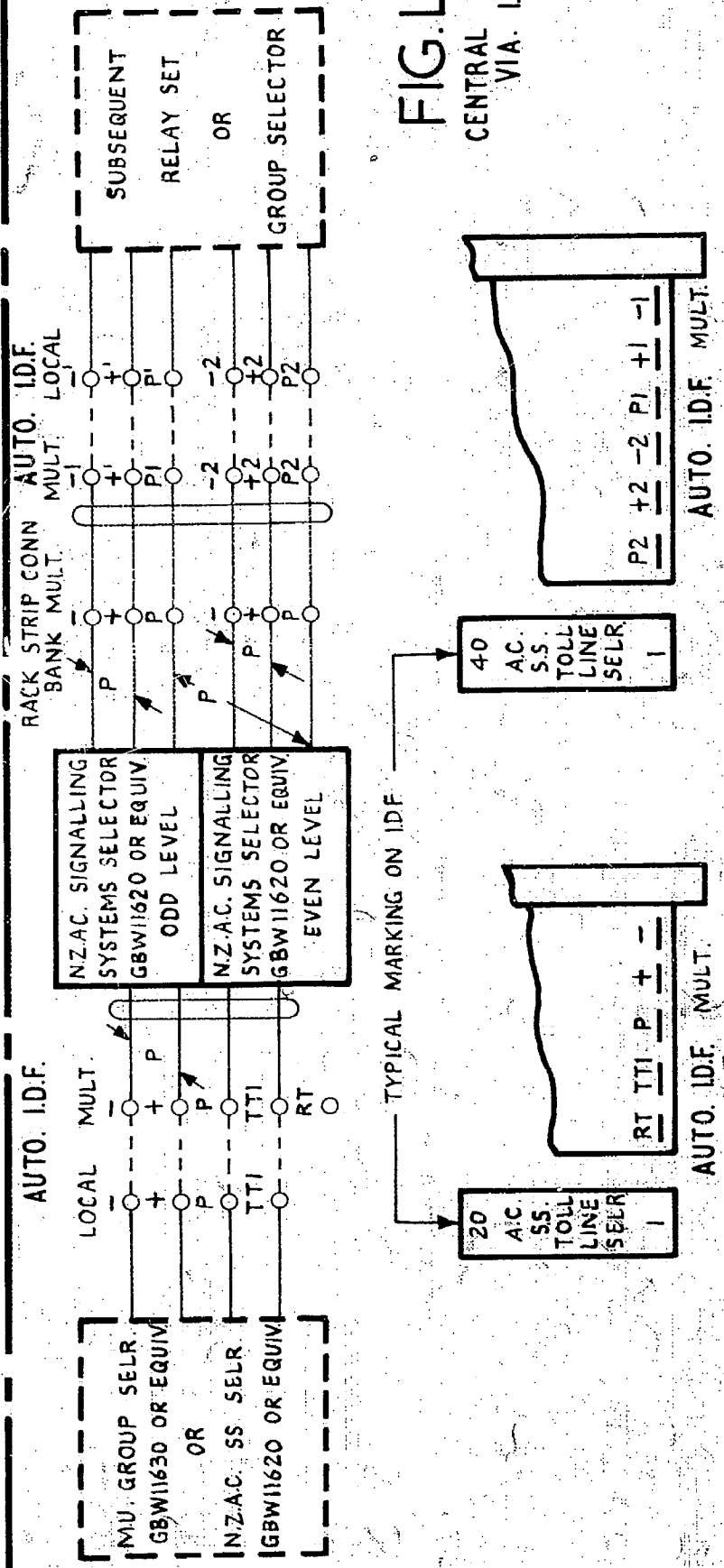

FIG. L

CENTRAL GRADING
VIA. IDF.

N.Z.P.O.	DRAWN MH	CHECKED MH	WIRING	CIRCUIT ASH
AMENDMENT PARTICULARS		ISSUE	DATE	APP
(9775)		5	17-6-68	

NZ.A.C. SIGNALLING
SYSTEMS SELECTOR 200 OUTLET
(NOTE 2)
ABSENCE OF EARTH OR BATTERY TESTED
2000 TYPE

REF - VF

GBX 11620
11621

SHT.6-10

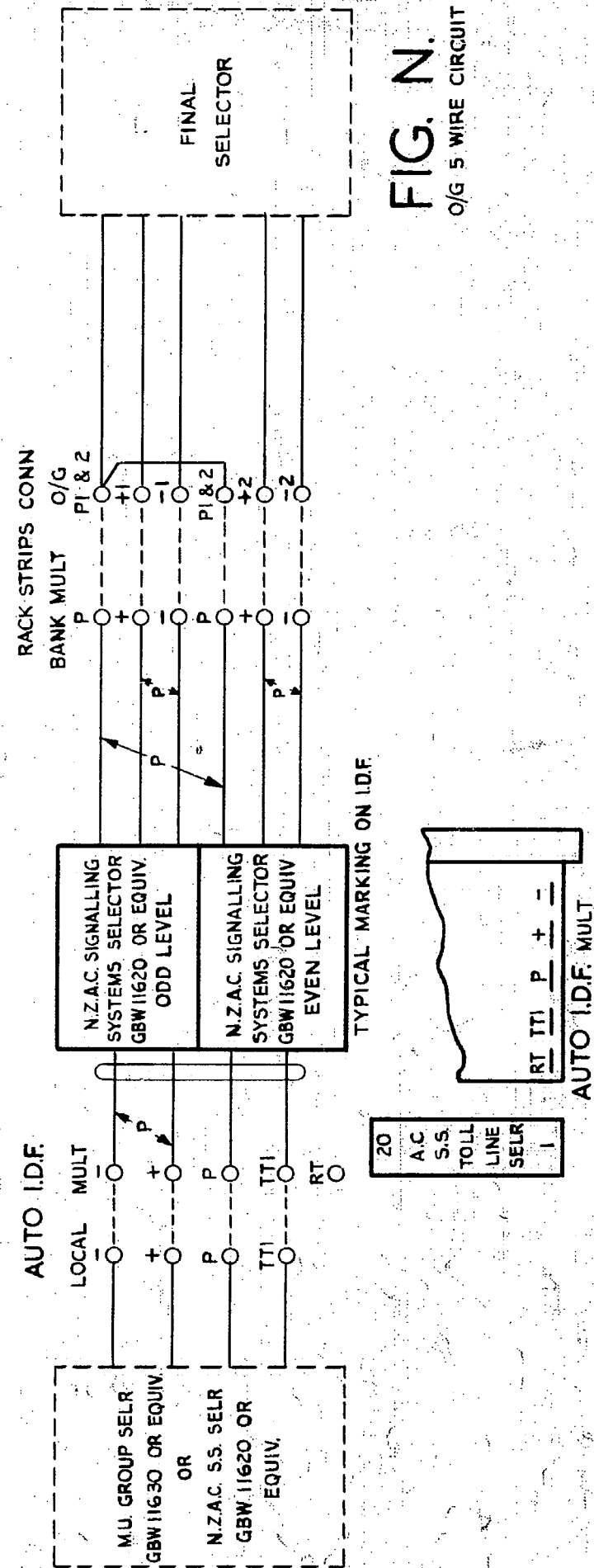
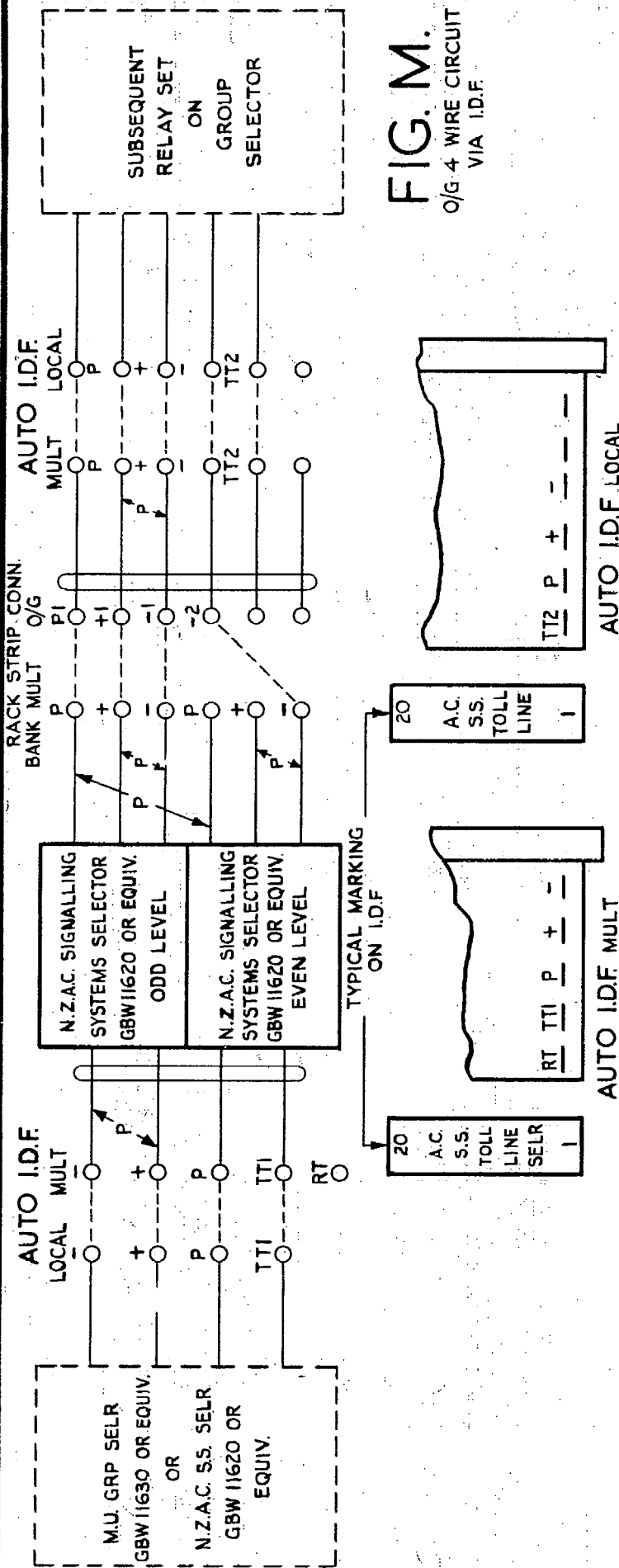

				N.Z.A.C. SIGNALLING SYSTEMS SELECTOR 200 OUTLET (NOTE 2)			
				ABSENCE OF EARTH OR BATTERY TESTED 2000 TYPE			
				(9775)	5	17.6.68	
AMENDMENT PARTICULARS				ISSUE	DATE	APP	REF. - VF.
							S
N.Z.P.O.				DRAWN	CHECKED	WIRING	CIRCUIT
				MH	MH	GH	GBX 11620 11621
							SHEET 7-10

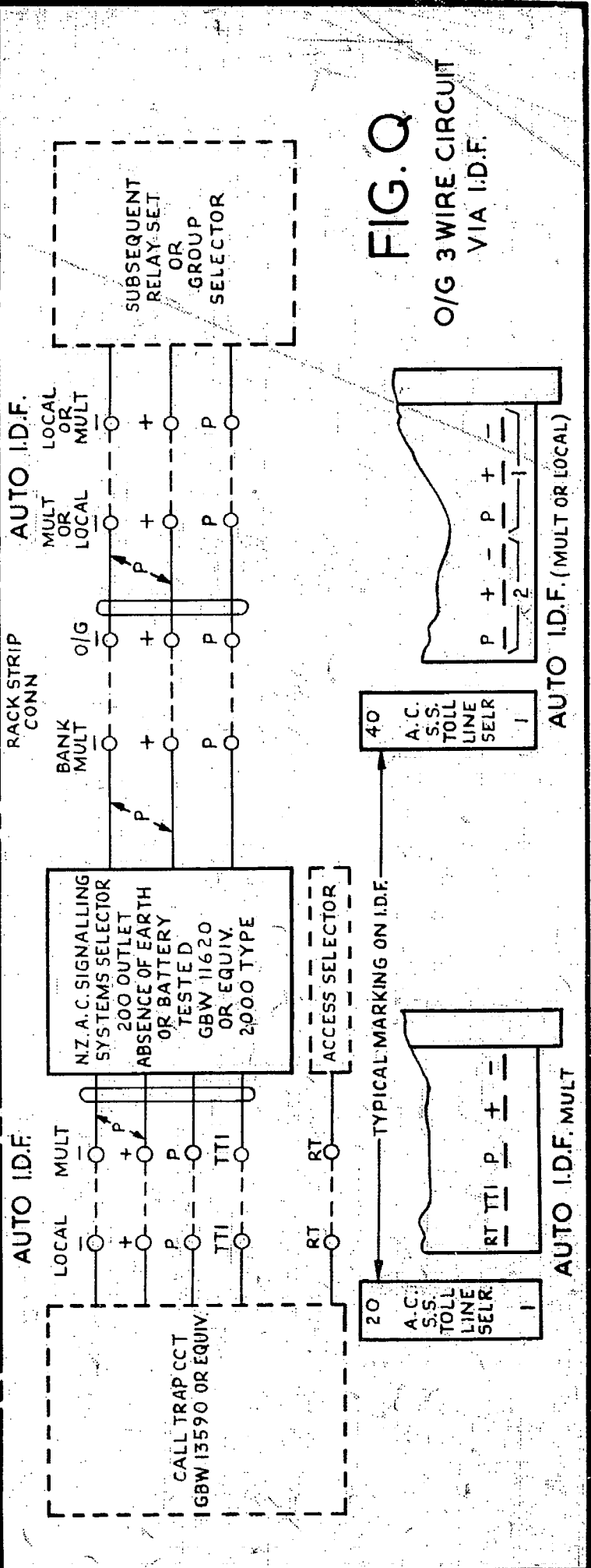
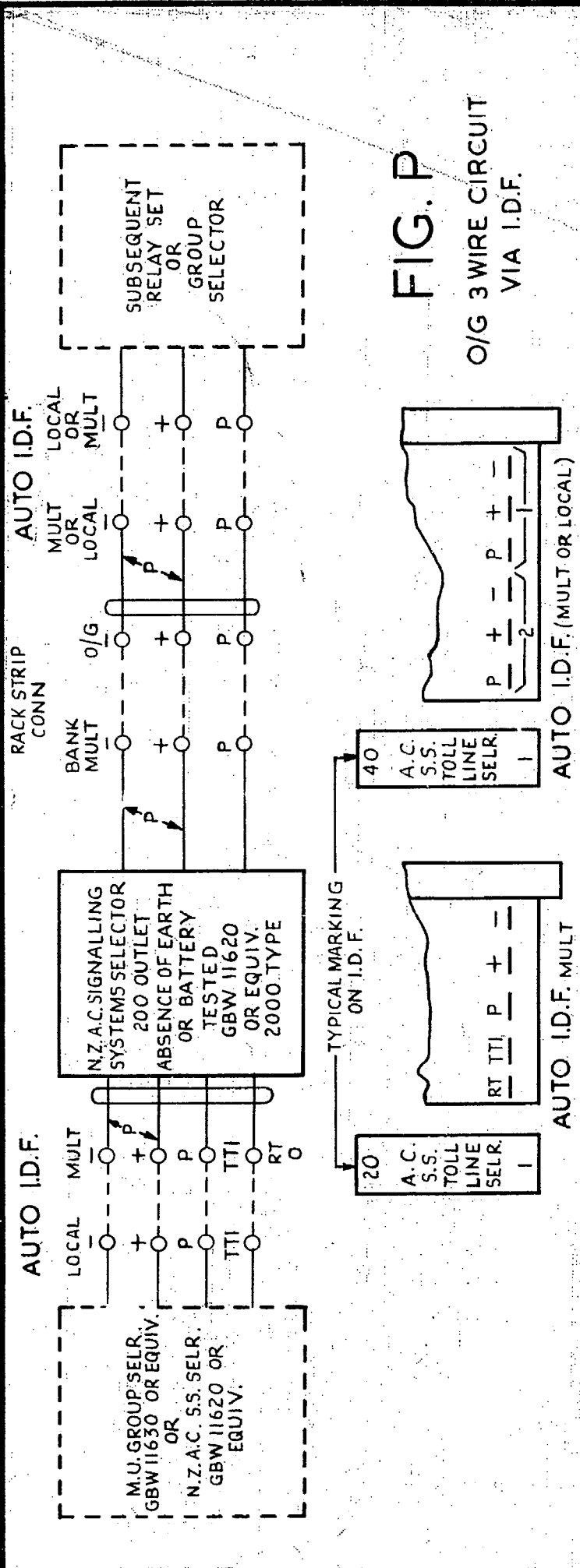

				N.Z.A.C. SIGNALLING SYSTEMS SELECTOR 200 OUTLET (NOTE 2) ABSENCE OF EARTH OR BATTERY TESTED 2000 TYPE	
		(9775)	5	17/6/68	SE
AMENDMENT PARTICULARS			ISSUE	DATE	APP.
				REF. - VF	
N.Z.P.O.		DRAWN MH	CHECKED MH	WIRING CIRCUIT FCH	GBX 11620 11621
					SHTS. 8-10

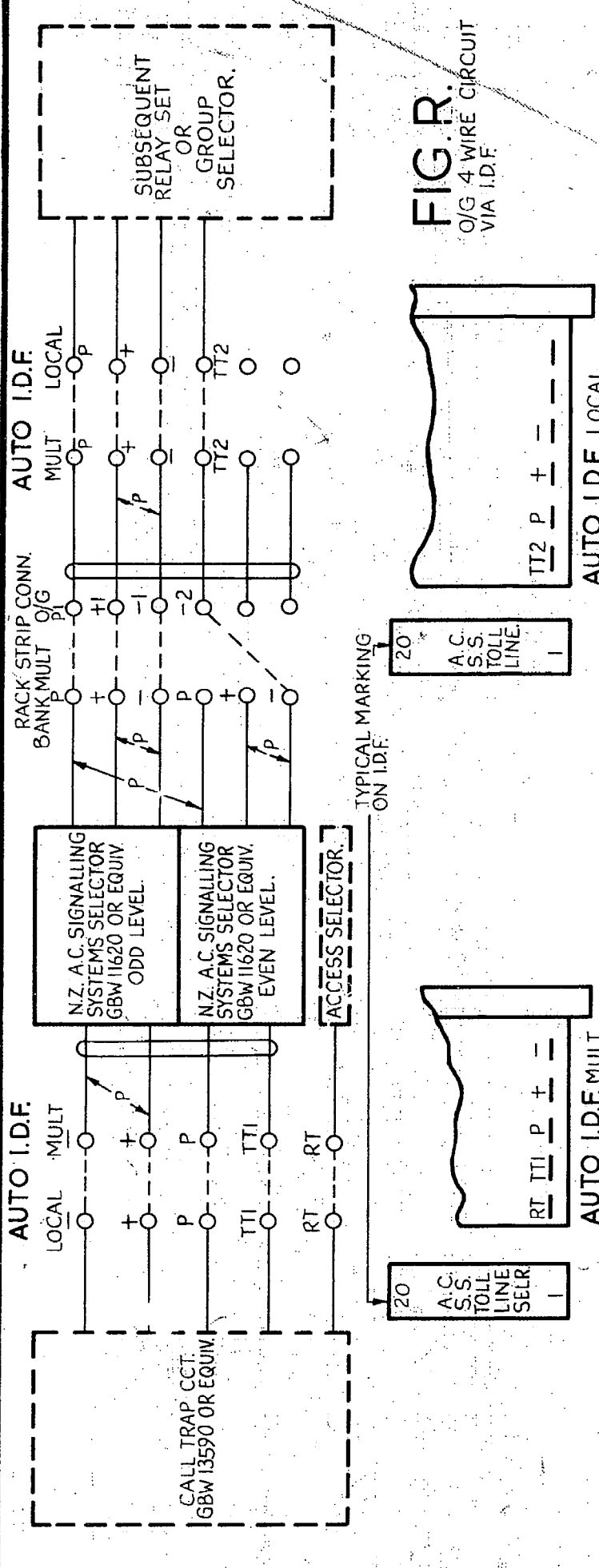

FIG. R.
O/G 4 WIRE CIRCUIT
VIA I.D.F.

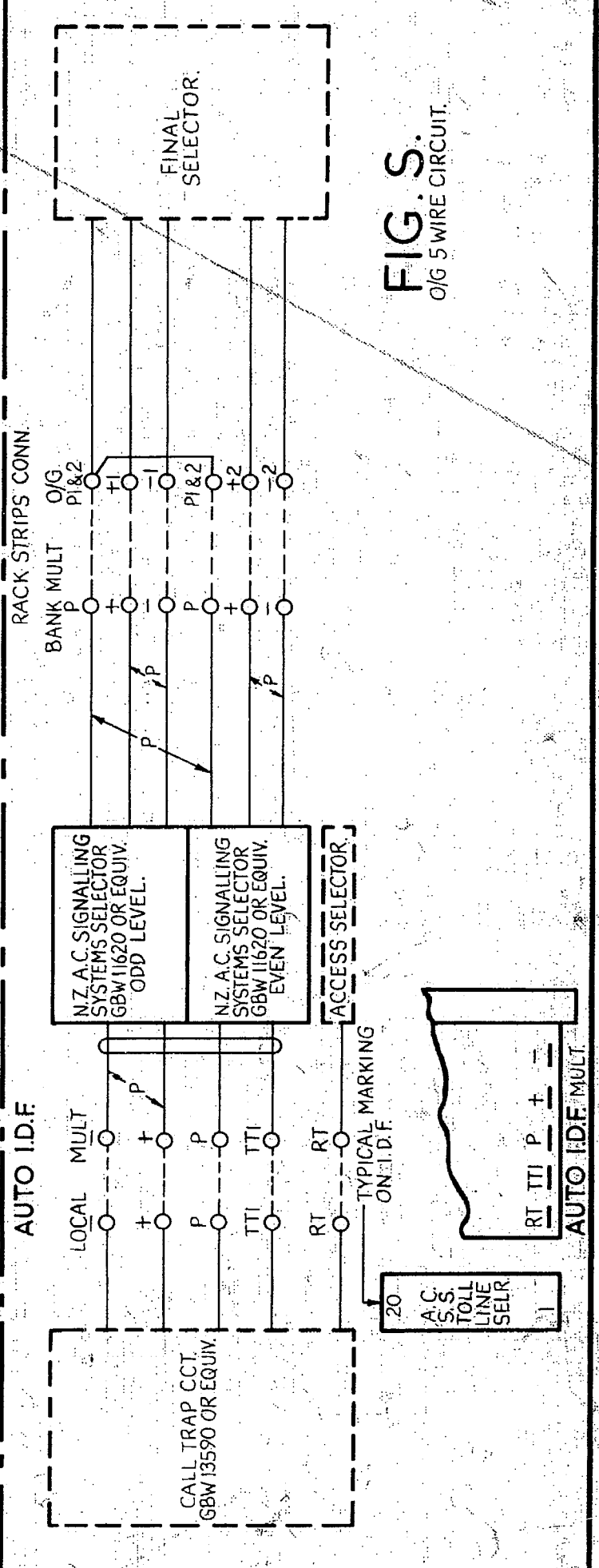

FIG. S.
O/G 5 WIRE CIRCUIT.

N.Z.P.O.	DRAWN MH	CHECKED MH	WIRING CIRCUIT ASH
AMENDMENT PARTICULARS		ISSUE	DATE
(9775)		5	17-6-68

N.Z. A.C. SIGNALLING
SYSTEMS SELECTOR 200 OUTLET
(NOTE 2)
ABSENCE OF EARTH OR BATTERY TESTED
2000 TYPE

REF -V.F.

**GBX 11620
11621**

SHEET. 9-10

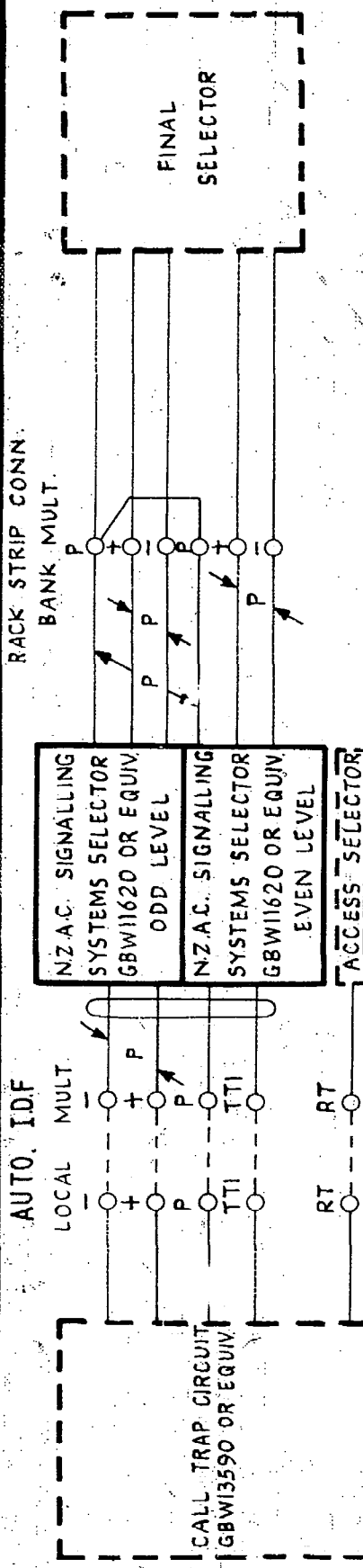

FIG. T
O/G 5 WIRE CIRCUIT
(FULL AVAILABILITY)

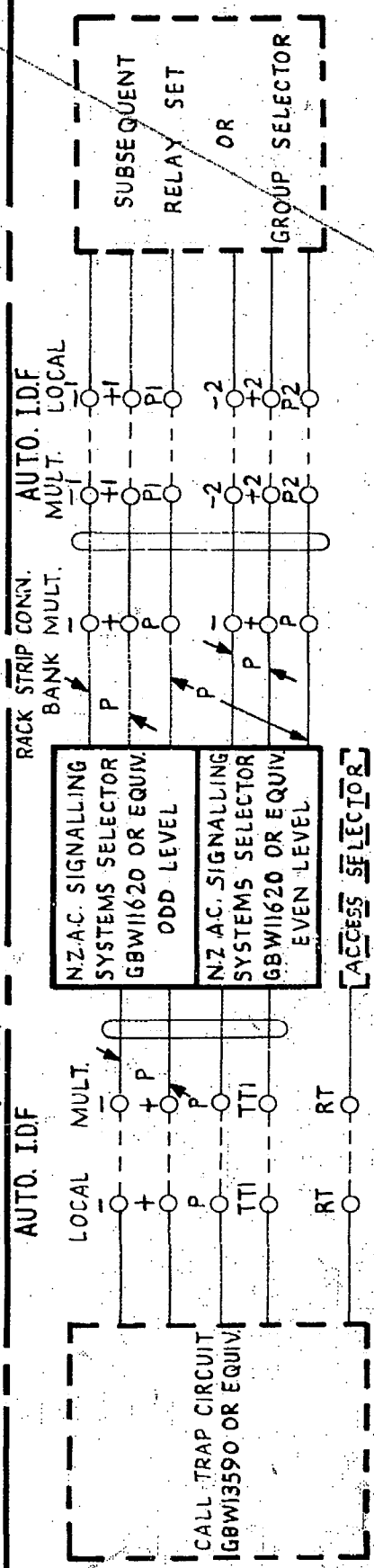

FIG. U
CENTRAL GRADING
VIA. IDF

NZ.P.O.	DRAWN MH	CHECKED MH	WIRING CIRCUIT	ISSUE DATE	APP	REF -VF	S
AMENDMENT PARTICULARS			(9775)	5	17.6.68		

N.Z.A.C. SIGNALLING
SYSTEMS SELECTOR 200 OUTLET
(NOTE 2)
ABSENCE OF EARTH OR BATTERY TESTED
2000 TYPE

GBX 11620
11621

SHT 10 - 10