

**FIG. 1. REGULAR & 2-10 P.B.X. SUBSCRIBERS ON CHANGED NUMBER.**  
(EXCHANGES WITHOUT IDF.)

NOTES :-  
1. THE + AND - STRAPS MUST BE REMOVED WHEN DIVERSION TO CHANGED NUMBER CALLING EQUIPMENT IS MADE.

|  |       |          |           |
|--|-------|----------|-----------|
| WAS SHEET 1-8 (30561)                          | 5     | 14-1-55  | CCW       |
| NO. CHANGE ISSUE ADVANCED ONLY (30561)         | 4     | 14-1-55  | CCW       |
| + & - STRAPS DELETED. NOTE 1.1. ADDED. (31668) | 3     | 2-5-54   | CCW       |
| SHTS. 6, 7 & 8 MODIFIED.                       | 2     | 22-12-50 |           |
|  | 1     | 7-6-50   |           |
| AMENDMENT PARTICULARS                          | ISSUE | DATE     | APPD      |
| N.Z. P.O.                                      | DRAWN | CHECKED  | WIRING    |
|  |       |          | ENGINEERS |

**CHANGED NUMBER CALLING EQUIPMENT. TAPPING CIRCUIT & LINE FINDER.**

**GBX. 10720.**

SHEET 1-10

0 5 Centimetres 10 15 20 25 30

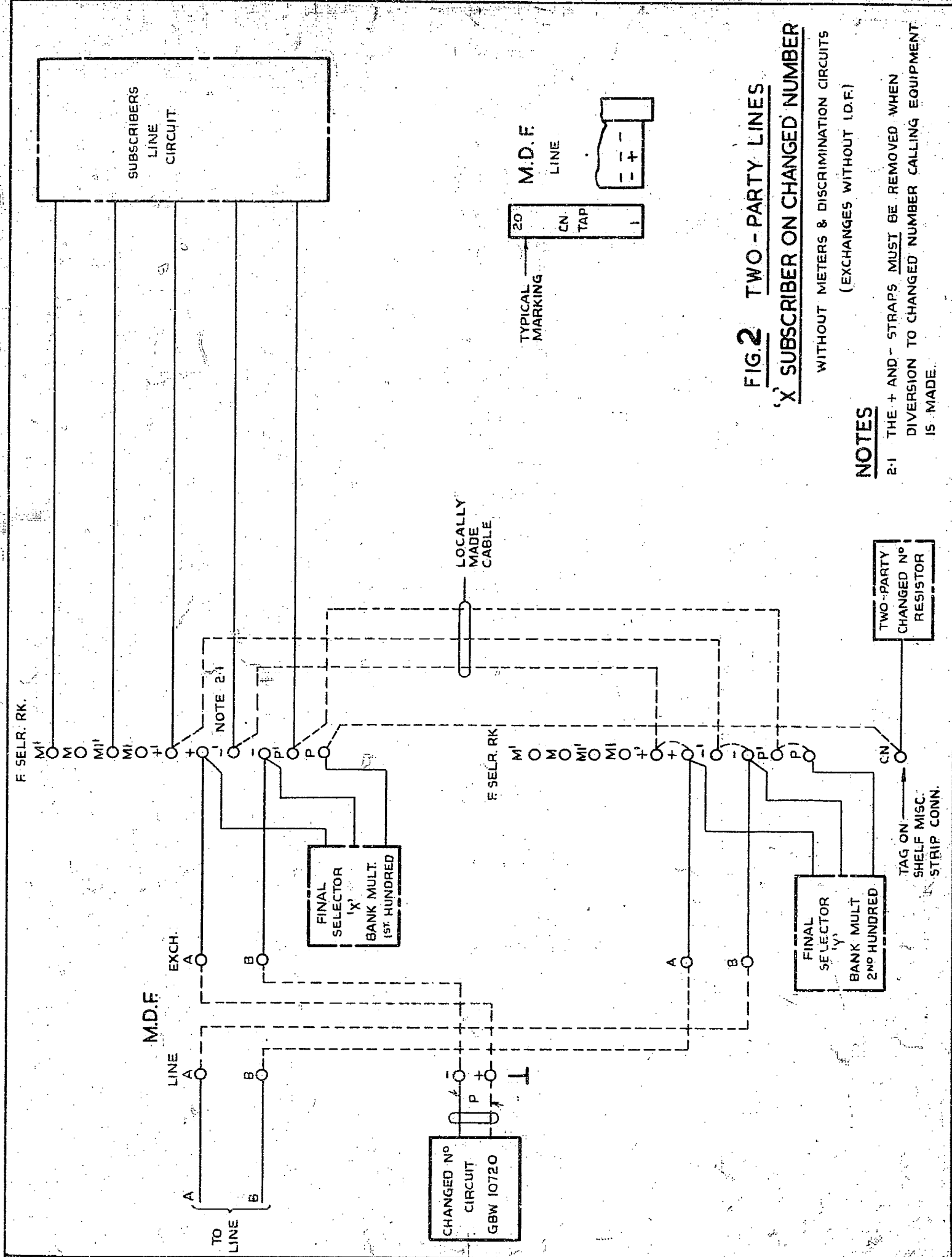
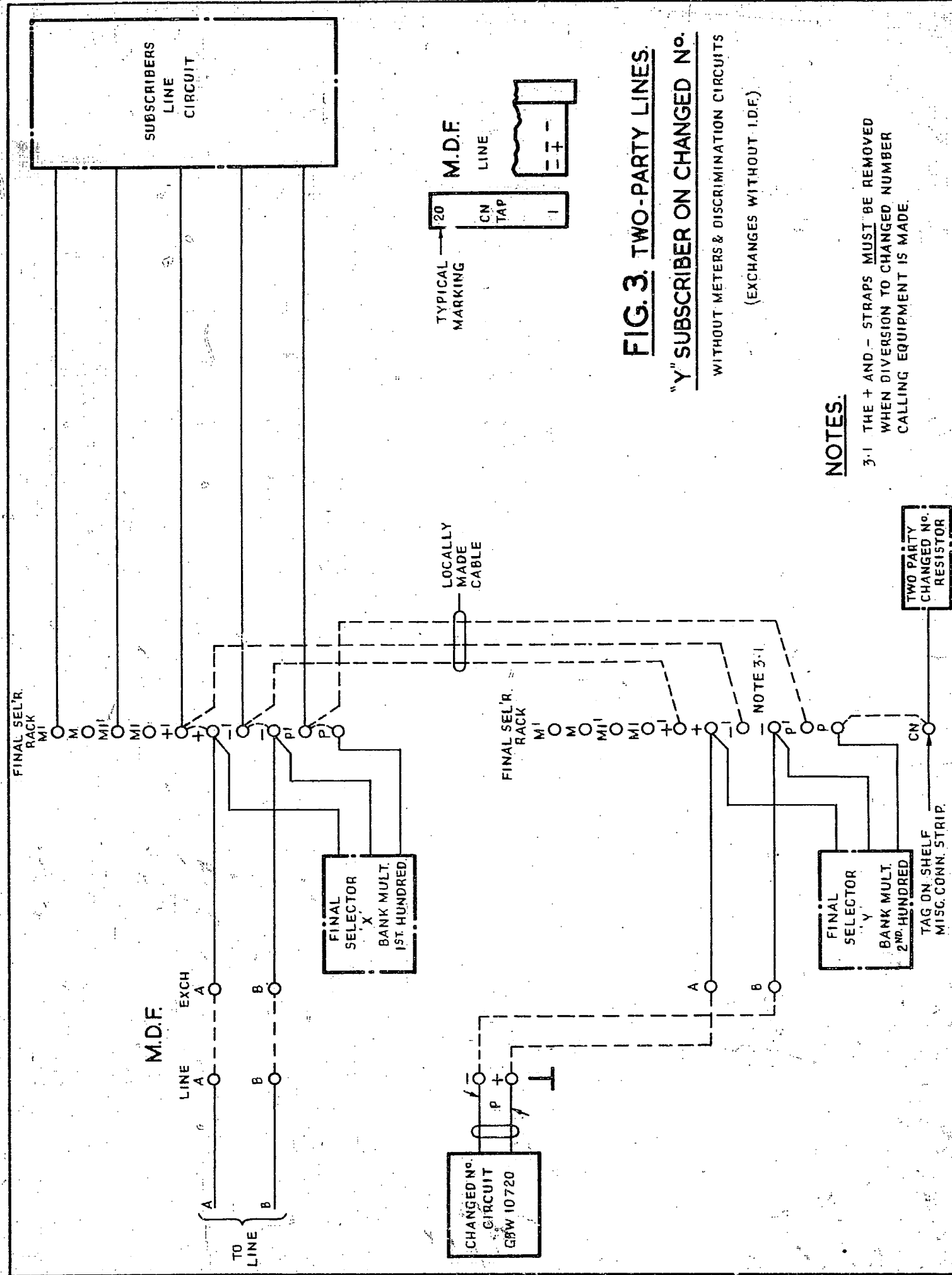

**FIG 2 TWO-PARTY LINES**  
**'X' SUBSCRIBER ON CHANGED NUMBER**  
 WITHOUT METERS & DISCRIMINATION CIRCUITS  
 (EXCHANGES WITHOUT I.D.F.)

**NOTES**  
 2-1 THE + AND - STRAPS MUST BE REMOVED WHEN DIVERSION TO CHANGED NUMBER CALLING EQUIPMENT IS MADE

|   |  |         |         |         |           |
|---|--|---------|---------|---------|-----------|
| <b>CHANGED NUMBER CALLING EQUIPMENT TAPPING CIRCUIT &amp; LINE FINDER</b> |  |         |         |         |           |
|   |  | (30561) | 5       | 14.1.55 | CUT       |
| AMENDMENT PARTICULARS   |  | ISSUE   | DATE    | APPD    | E         |
| N.Z.P.O   |  | DRAWN   | CHECKED | WIRED   | ENGRS.    |
| <b>GBX 10720</b>  |  |         |         |         | SHT. 2-10 |

0 5 Centimetres 10 15 20 25 30



**FIG. 3. TWO-PARTY LINES.**

**"Y" SUBSCRIBER ON CHANGED No.**

WITHOUT METERS & DISCRIMINATION CIRCUITS

(EXCHANGES WITHOUT I.D.F.)

**NOTES.**

- 3.1 THE + AND - STRAPS MUST BE REMOVED WHEN DIVERSION TO CHANGED NUMBER CALLING EQUIPMENT IS MADE.

|                       |  |        |         |         |         |
|-----------------------|--|--------|---------|---------|---------|
| AMENDMENT PARTICULARS |  | (3056) | 5       | 14.1.55 | CSH     |
| N.Z.P.O.              |  | DRAWN  | CHECKED | WIRING  | CIRCUIT |

**CHANGED NUMBER CALLING EQUIPMENT TAPPING CIRCUIT & LINE FINDER**

**GBX 10720**

**SHEET 3-10.**

0 5 Centimetres 10 15 20 25 30

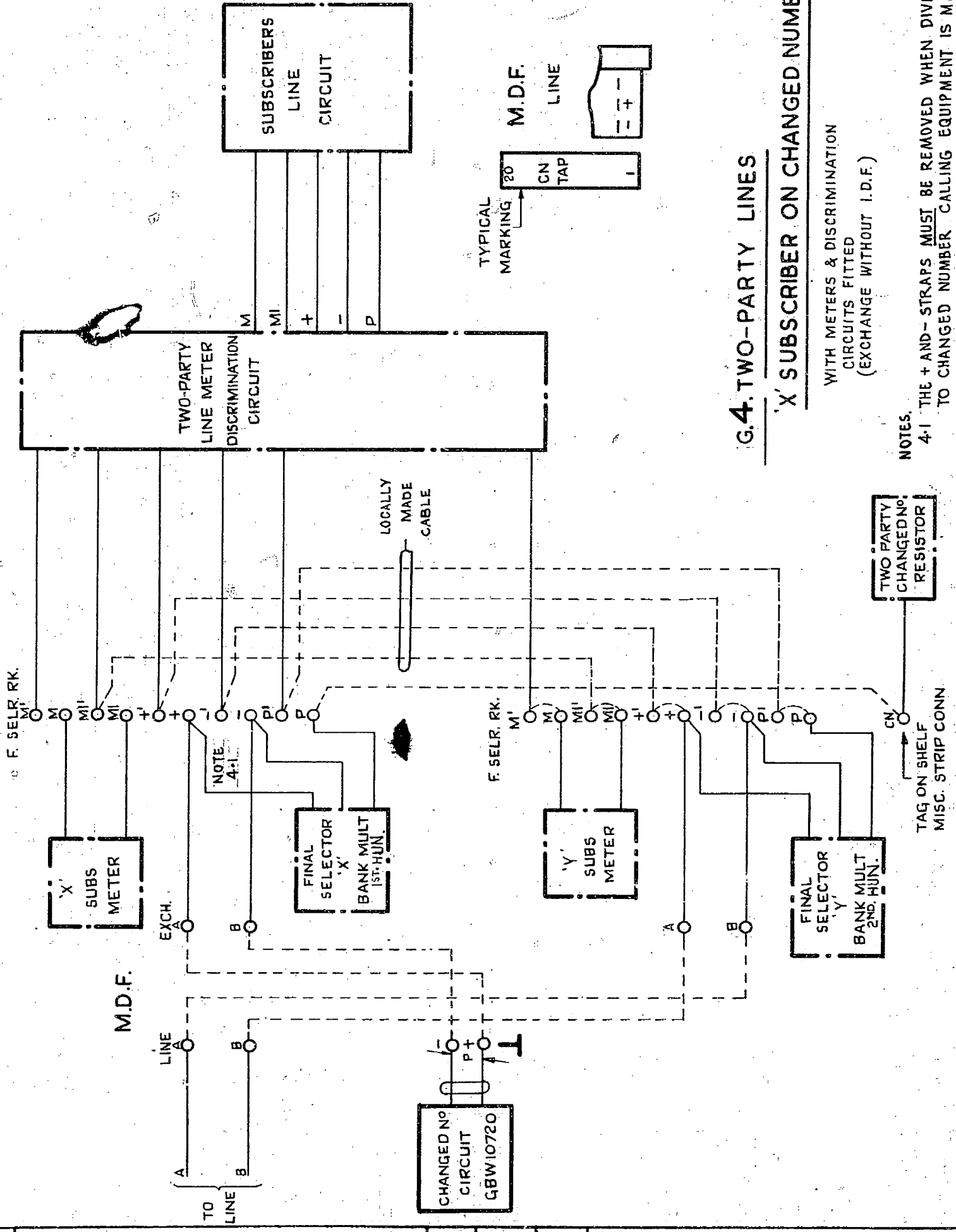

**G.4. TWO-PARTY LINES**  
**'X' SUBSCRIBER ON CHANGED NUMBER**  
 WITH METERS & DISCRIMINATION  
 CIRCUITS FITTED  
 (EXCHANGE WITHOUT I.D.F.)  
**NOTES:**  
 4-1 THE + AND - STRAPS MUST BE REMOVED WHEN DIVERSION  
 TO CHANGED NUMBER CALLING EQUIPMENT IS MADE.

|  |       |          |      |
|--|-------|----------|------|
| AMENDMENT PARTICULARS  | ISSUE | DATE     | APPD |
| WAS FIG.2 SHEET 2-8 NOTE 4-1 ADDED (30561)                   | 5     | 14-1-55  | CSW  |
| X-Y PARTY JUMPERS REVISED 1ST & 2ND HUNS. INDICATED. (30561) | 4     | 14-1-55  | CSW  |
| ISSUE ADVANCED. SHEETS 1 & 6 AMENDED. (31668)                | 3     | 4-5-54   | CSW  |
| SHTS. 6, 7 & 8 MODIFIED                                      | 2     | 22-12-50 | CSW  |
|  | 1     | 7-6-50   | CSW  |

**CHANGED NUMBER  
 CALLING EQUIPMENT  
 TAPPING CIRCUIT & LINE FINDER**

**GBX 10720**

N.Z. P.O. *[Signature]* DRAWN *[Signature]* CHECKED *[Signature]* WIRING *[Signature]* ENGINEER *[Signature]*

SHEET 4-10

Centimetres

5

10

15

20

25

30

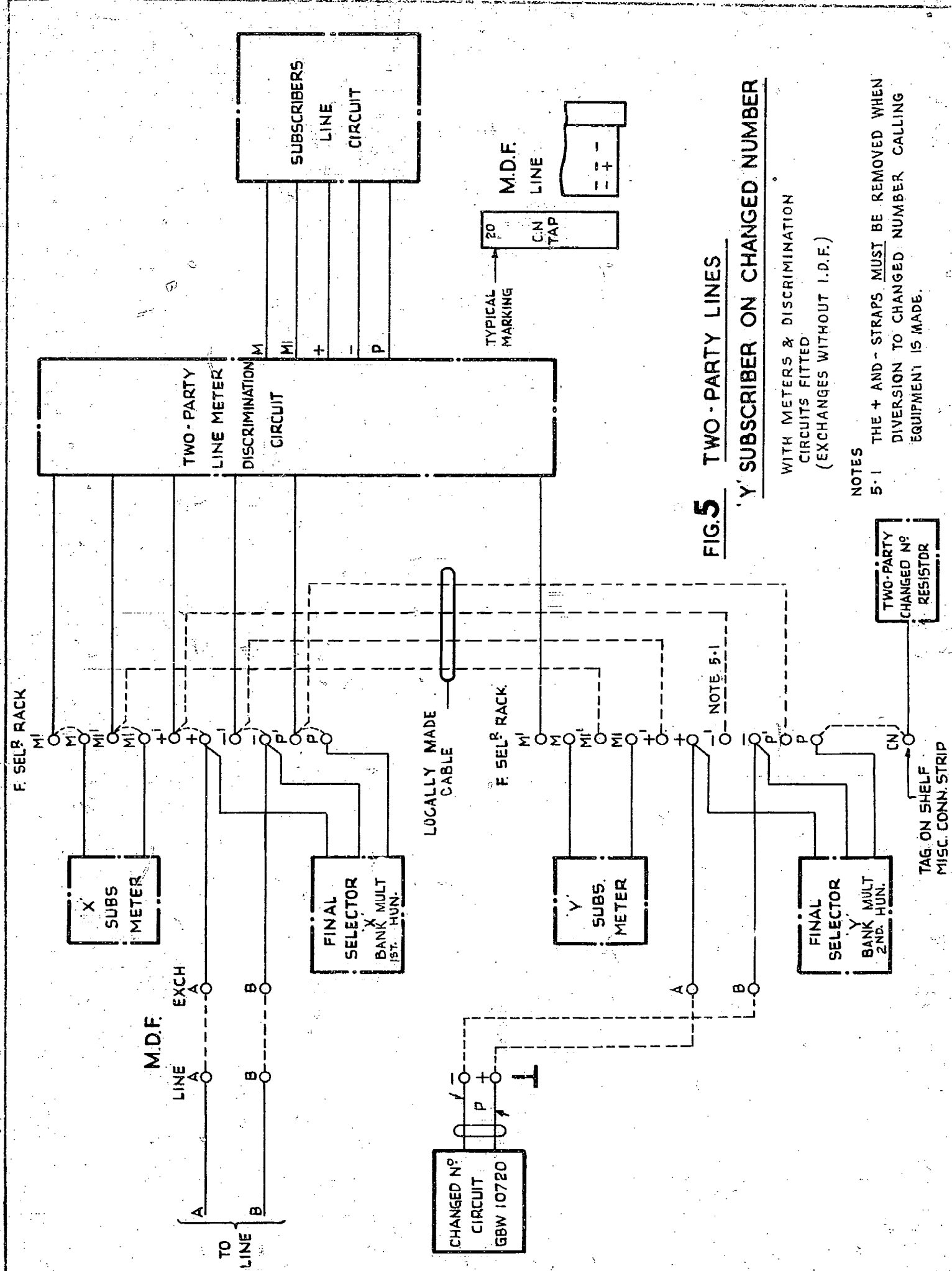

**FIG. 5** TWO-PARTY LINES  
 'Y' SUBSCRIBER ON CHANGED NUMBER

WITH METERS & DISCRIMINATION  
 CIRCUITS FITTED  
 (EXCHANGES WITHOUT I.D.F.)

NOTES

5-1 THE + AND - STRAPS MUST BE REMOVED WHEN  
 DIVERSION TO CHANGED NUMBER CALLING  
 EQUIPMENT IS MADE.

|                       |         |        |          |      |
|-----------------------|---------|--------|----------|------|
| AMENDMENT PARTICULARS |         | ISSUE  | DATE     | APPD |
| N.Z. P.O.             |         |        |          |      |
| DRAWN                 | CHECKED | WIRING | ENGINEER |      |

**CHANGED NUMBER  
 CALLING EQUIPMENT  
 TAPPING CIRCUIT & LINE FINDER**

**GBX 10720**

SHT 5-10

0 5 Centimetres 10 15 20 25 30

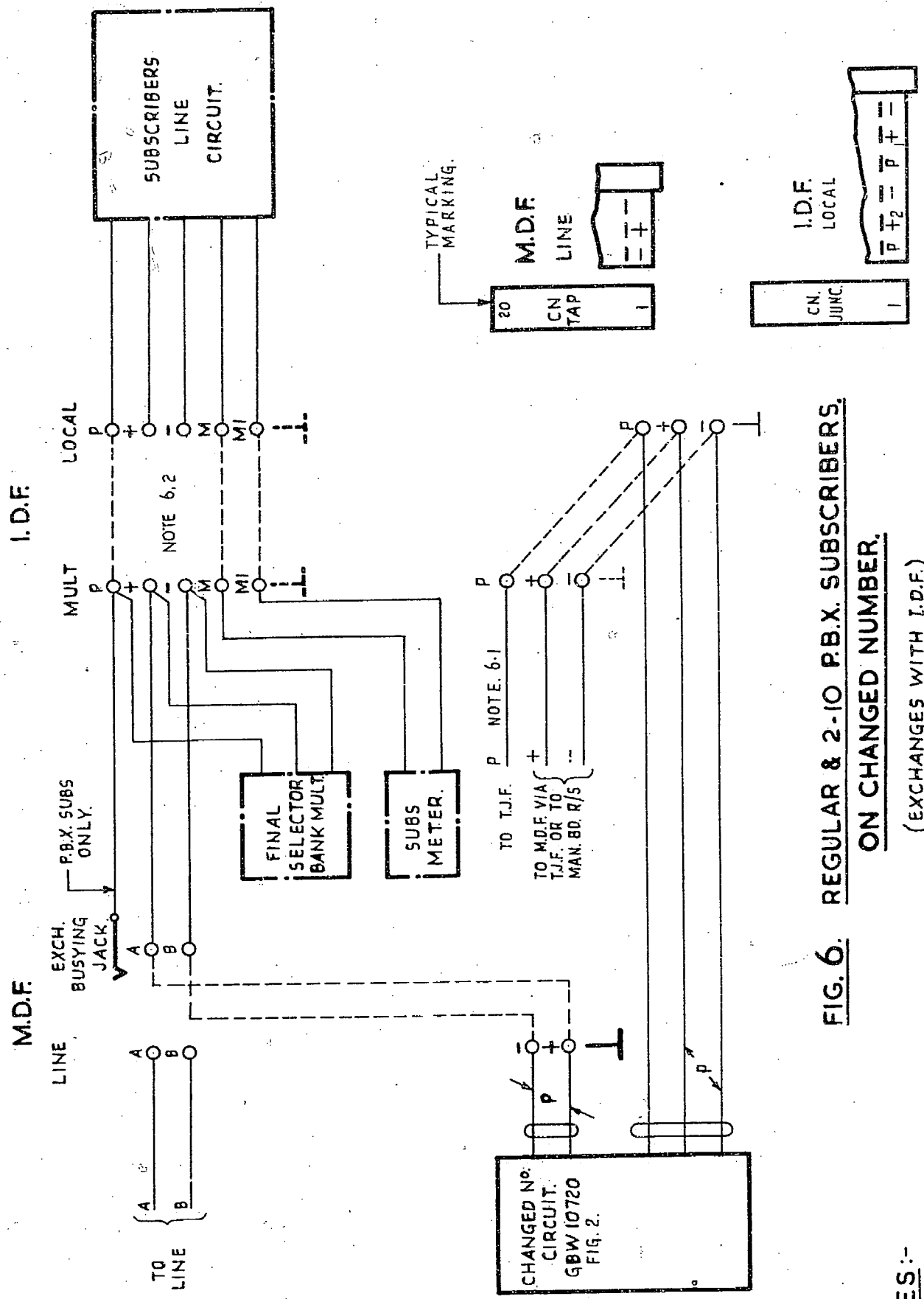

**FIG. 6. REGULAR & 2-10 P.B.X. SUBSCRIBERS. ON CHANGED NUMBER.**  
(EXCHANGES WITH I.D.F.)

**NOTES:-**  
6.1. 'P' LEAD IS NOT REQ'D WHEN + & - LEADS ARE CONNECTED TO MANUAL BOARD RELAY SET.  
6.2. THE + & - JUMPERS MUST BE REMOVED WHEN DIVERSION TO CHANGED NUMBER CALLING EQUIPMENT IS MADE.

| AMENDMENT PARTICULARS                              | ISSUE | DATE     | APPD |
|--|-------|----------|------|
| WAS SHEET 6-8 (30561)                              | 5     | 14-1-55  | W.D. |
| NO CHANGE ISSUE ADVANCED ONLY (30561)              | 4     | 14-1-55  | W.D. |
| + & - JUMPERS DELETED. NOTE 6.2. ADDED (31008)     | 3     | 4-5-54   | W.D. |
| FIGS. 6, 7 & 8 MODIFIED. NOTES 6.1, 7.1, 8.1 ADDED | 2     | 22-12-50 | W.D. |
|  | 1     | 7-6-50   |      |

**CHANGED NUMBER CALLING EQUIPMENT TAPPING CIRCUIT & LINE FINDER**

**GBX 10720**

SHEET 6-10

0 5 Centimetres 10 15 20 25 30

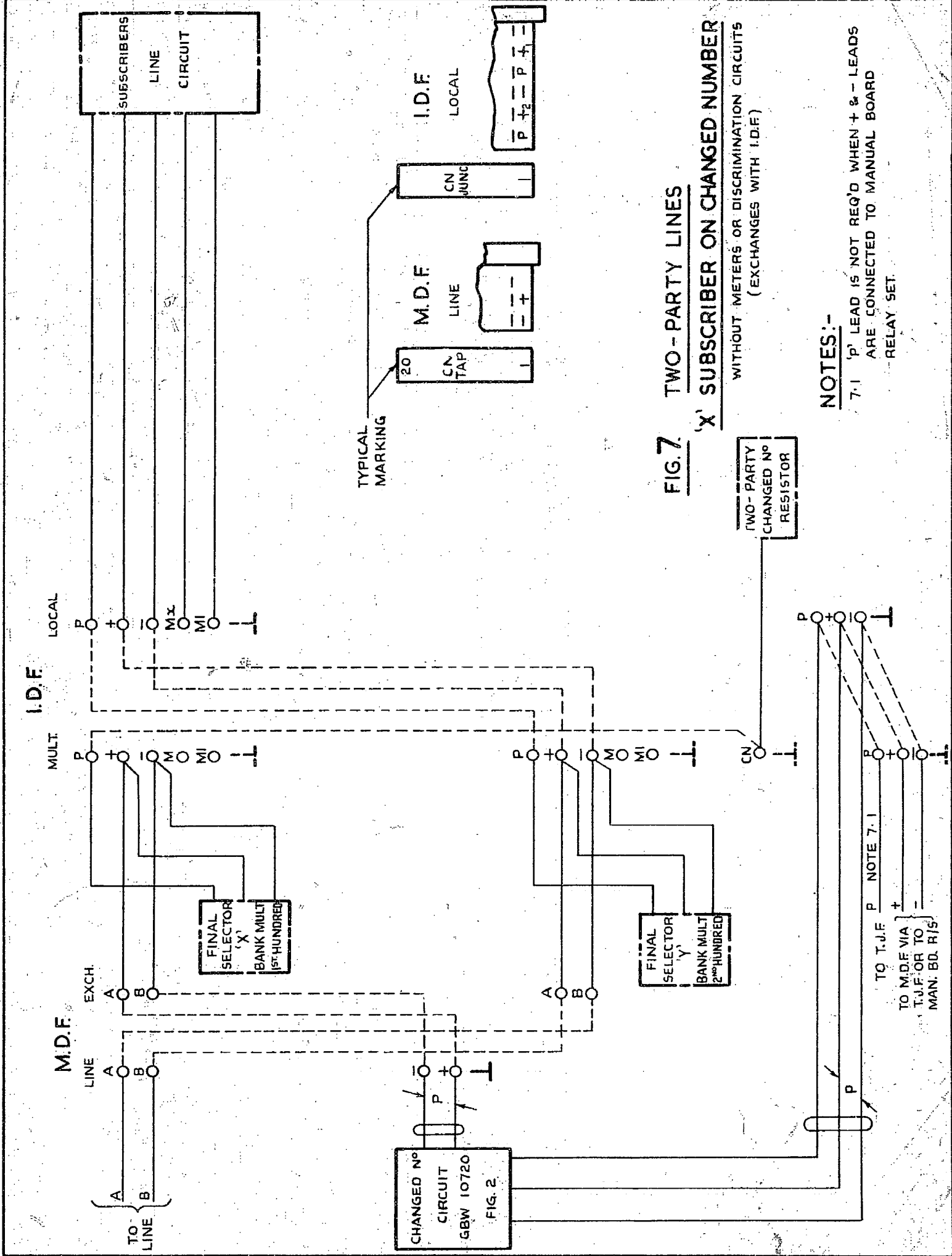

FIG. 7. TWO-PARTY LINES

'X' SUBSCRIBER ON CHANGED NUMBER  
 WITHOUT METERS OR DISCRIMINATION CIRCUITS  
 (EXCHANGES WITH I.D.F.)

NOTES:-

7.1 'P' LEAD IS NOT REQ'D WHEN + & - LEADS ARE CONNECTED TO MANUAL BOARD RELAY SET.

|                       |  |         |         |         |       |
|-----------------------|--|---------|---------|---------|-------|
| N.Z.P.O.              |  | DRAWN   | CHECKED | WIRING  | ENGRS |
| AMENDMENT PARTICULARS |  | (30561) | 5       | 14.1.55 | cur   |
|                       |  | ISSUE   | DATE    | APP     | E     |

CHANGED NUMBER  
 CALLING EQUIPMENT  
 TAPPING CIRCUIT & LINE FINDER

**GBX 10720**

SHT 7-K

0 5 Centimetres 10 15 20 25 30

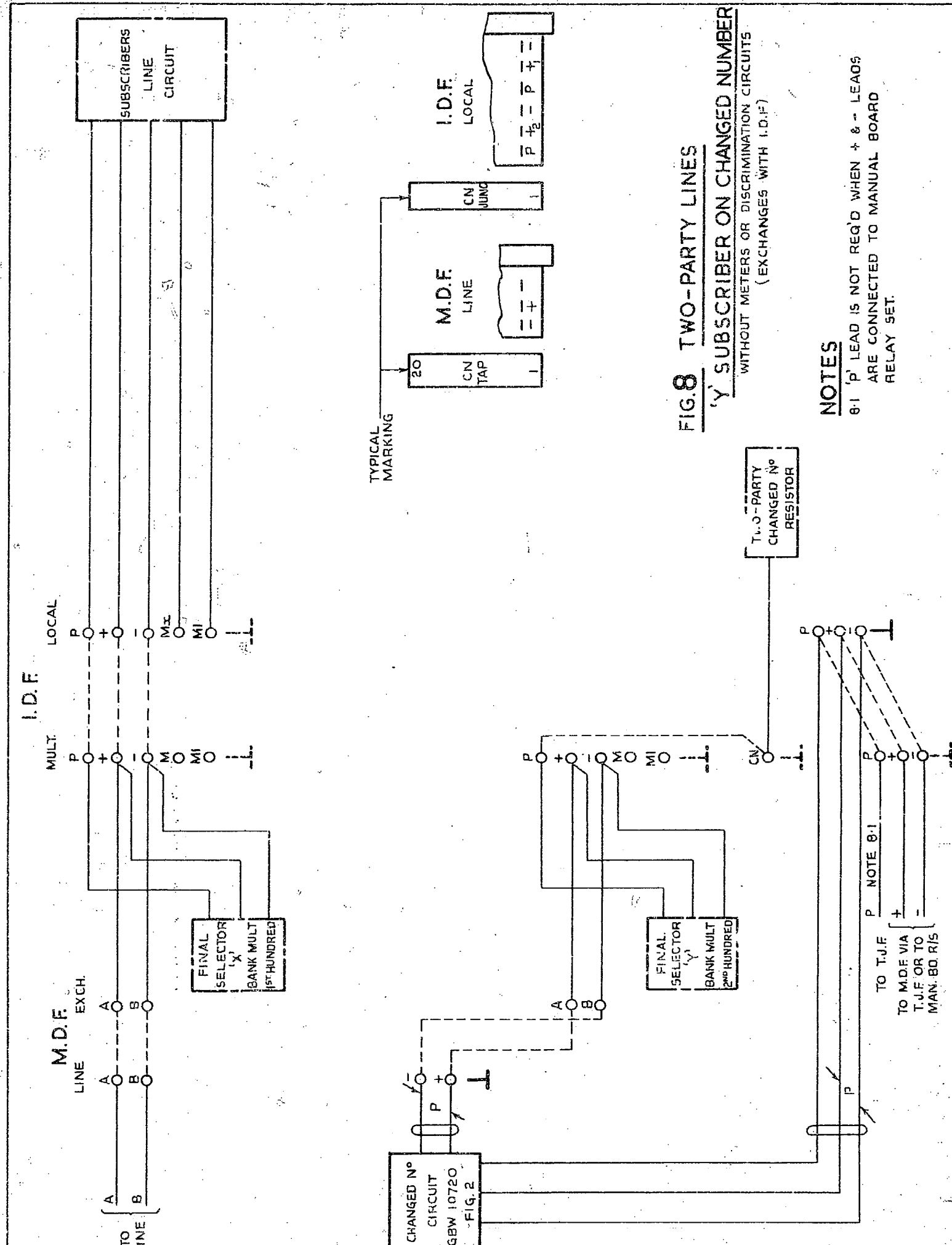

**FIG. 8 TWO-PARTY LINES**  
**'Y' SUBSCRIBER ON CHANGED NUMBER**  
WITHOUT METERS OR DISCRIMINATION CIRCUITS  
 (EXCHANGES WITH I.D.F.)

**NOTES**  
 8-1 'P' LEAD IS NOT REQ'D WHEN + & - LEADS  
 ARE CONNECTED TO MANUAL BOARD  
 RELAY SET.

|                       |  |         |         |         |       |
|-----------------------|--|---------|---------|---------|-------|
| N.Z.P.O.              |  | DRAWN   | CHECKED | WIRING  | ENGRS |
| AMENDMENT PARTICULARS |  | (30561) | 5       | 14-1-55 | CLW   |
|                       |  | ISSUE   | DATE    | APPD    | E     |

**CHANGED NUMBER  
 CALLING EQUIPMENT  
 TAPPING CIRCUIT & LINE FINDER**

**GBX 10720**

SHT. 8-10



0  
5 Centimetres  
10  
15  
20  
25  
30

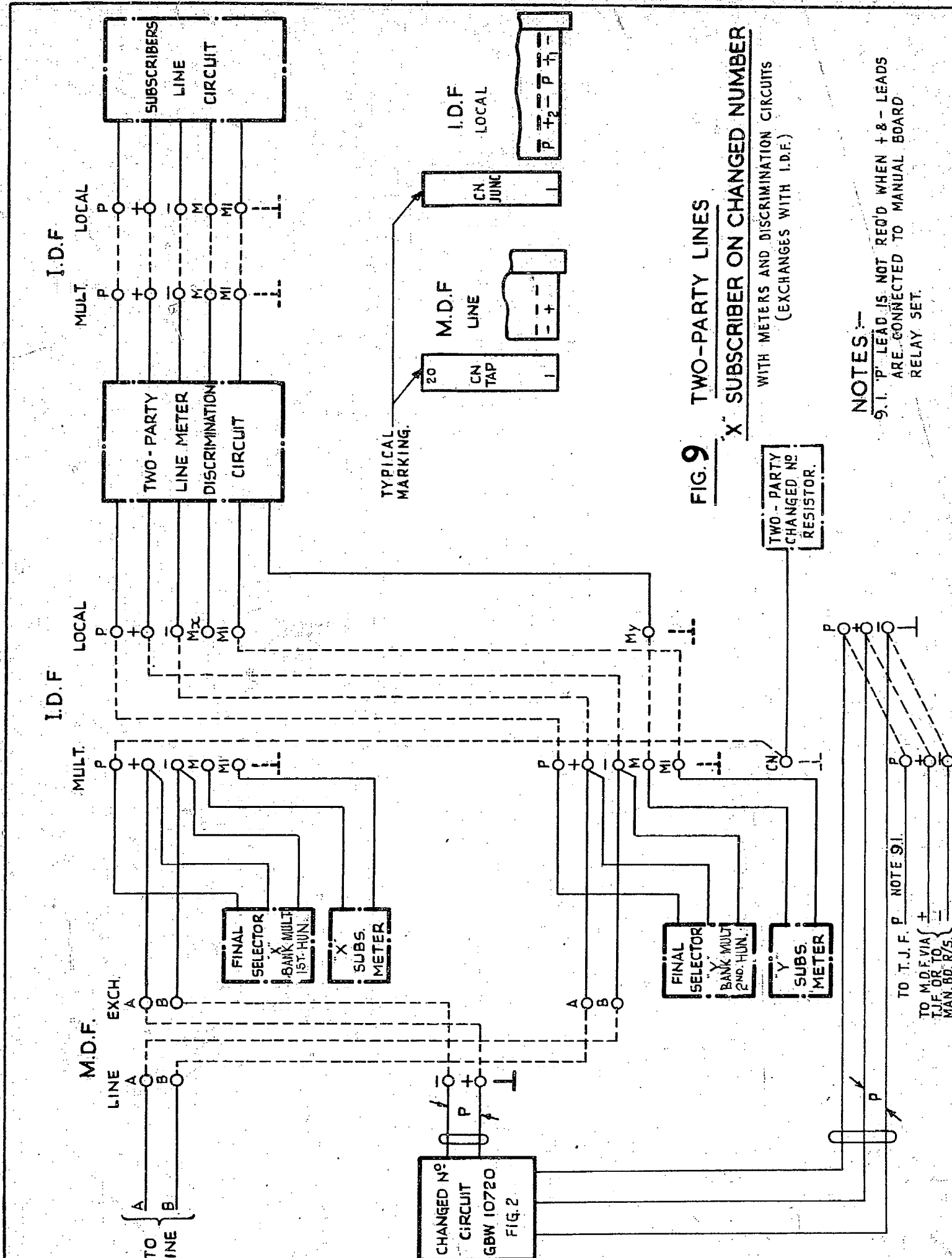

**FIG. 9** TWO-PARTY LINES  
 'X' SUBSCRIBER ON CHANGED NUMBER  
 WITH METERS AND DISCRIMINATION CIRCUITS  
 (EXCHANGES WITH I.D.F.)

**NOTES:-**  
 9.1 'P' LEAD IS NOT REQ'D WHEN + & - LEADS  
 ARE CONNECTED TO MANUAL BOARD  
 RELAY SET.

| AMENDMENT PARTICULARS                            |         |   |          | ISSUE | DATE | APPRO |
|--|---------|---|----------|-------|------|-------|
| WAS FIG. 7 SHEET 7-8                             | (30561) | 5 | 14.1.55  | CLB   |      |       |
| 1ST. & 2ND. HUNDREDS INDICATED                   | (30561) | 4 | 14.1.55  | CLB   |      |       |
| ISSUE ADVANCED. SHEETS 1 & 6 AMENDED             | (31668) | 3 | 4.5.54   | CLB   |      |       |
| FIGS 6, 7, 8, MODIFIED. NOTES 6, 7, 8, 1, ADDED. |         | 2 | 22.12.50 |       |      |       |
|  |         | 1 | 7.6.50   |       |      |       |

**CHANGED NUMBER  
 CALLING EQUIPMENT  
 TAPPING CIRCUIT & LINE FINDER**

**GBX 10720**

SHT. 9-10

N.Z. P.O. *[Signature]* DRAWN *[Signature]* CHECKED *[Signature]* WIRING *[Signature]* ENGINEER *[Signature]*

5 Centimetres

10

15

20

25

30

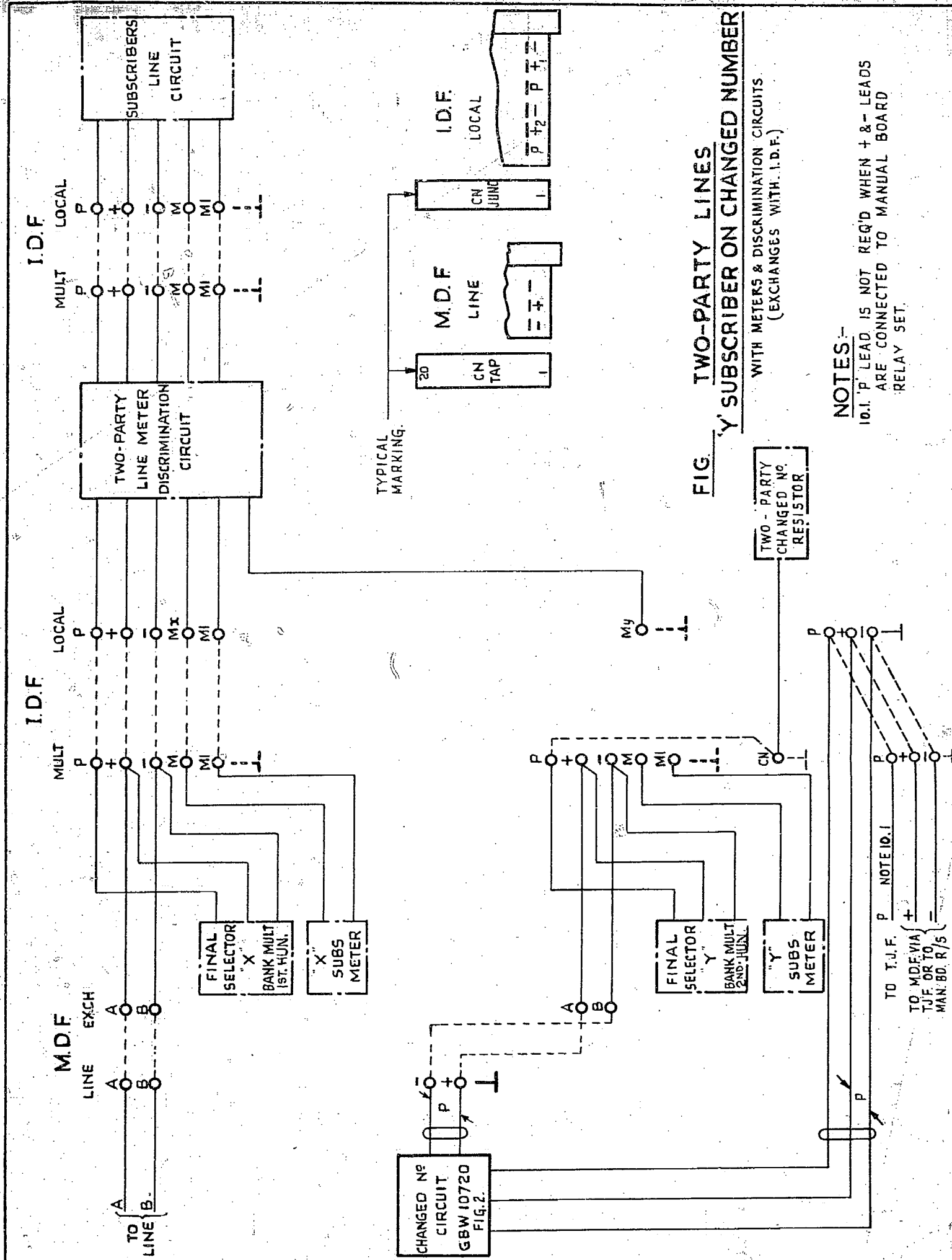

FIG. TWO-PARTY LINES 'Y' SUBSCRIBER ON CHANGED NUMBER WITH METERS & DISCRIMINATION CIRCUITS (EXCHANGES WITH I.D.F.)

NOTES:-  
10.1. P LEAD IS NOT REQ'D WHEN + & - LEADS ARE CONNECTED TO MANUAL BOARD RELAY SET.

|   |       |          |           |
|---|-------|----------|-----------|
| WAS FIG 8 SHEET 8-8 (30561)                     | 5     | 14.1.55  | CLW       |
| 1ST & 2ND HUNDREDS INDICATED (30561)            | 4     | 14.1.55  | CLW       |
| ISSUE ADVANCED. SHEETS 1 & 6 AMENDED. (31668)   | 3     | 4.5.54   | CLW       |
| FIGS 6, 7 & 8 MODIFIED. NOTES 6, 7, 8, 1 ADDED. | 2     | 22.12.50 | CLW       |
|   | 1     | 7.6.50   |           |
| AMENDMENT PARTICULARS                           | ISSUE | DATE     | APPD      |
| N.Z. P.O.                                       | DRAWN | CHECKED  | WIRING    |
|   |       |          | ENGINEERS |

CHANGED NUMBER CALLING EQUIPMENT. TAPPING CIRCUIT & LINE FINDER.

GBX 10720

SHEET 10-10