

0 5 10 15 20 25 30 35 40 45 50 55 60 65 70 75 80 85 90 95 100 Centimetres

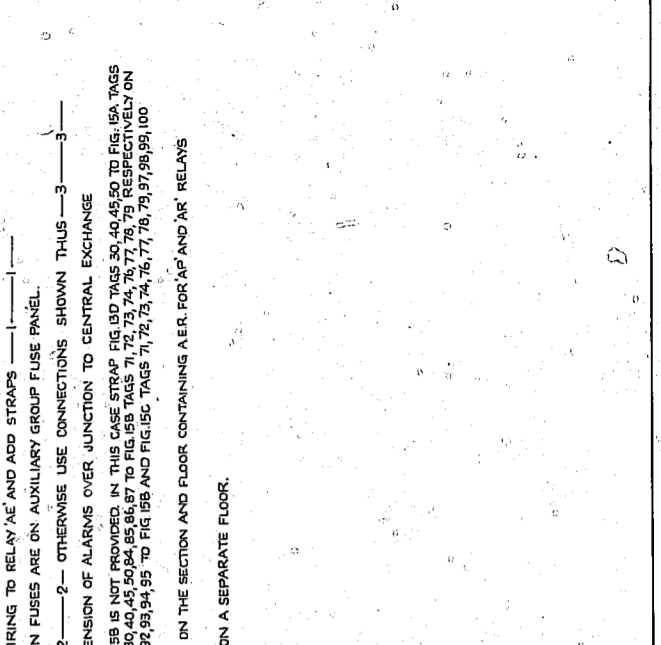
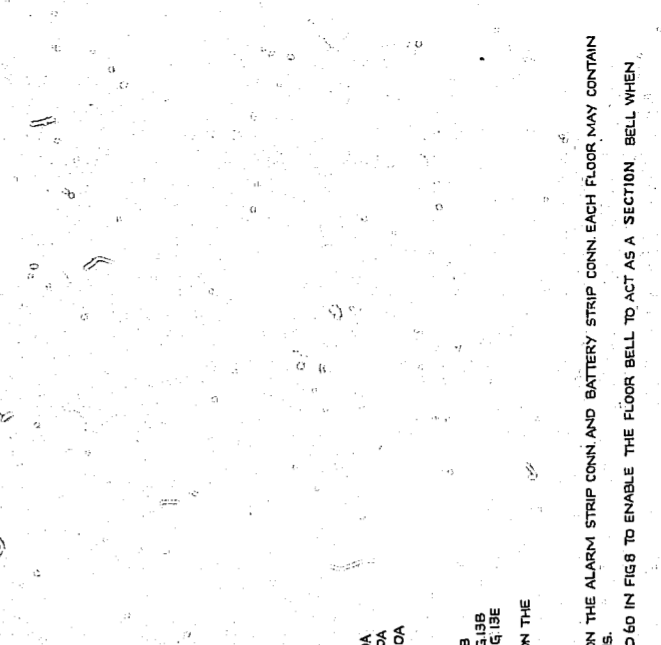
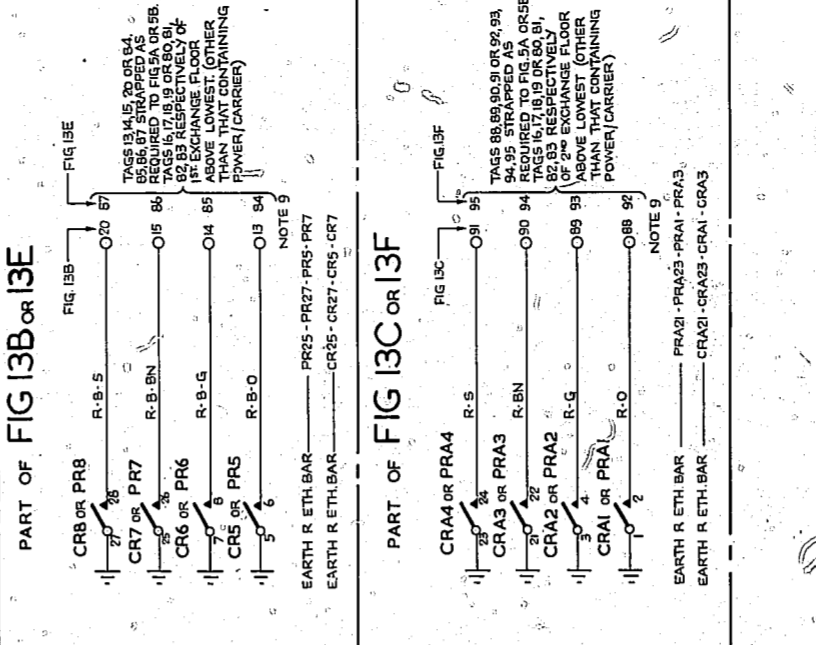
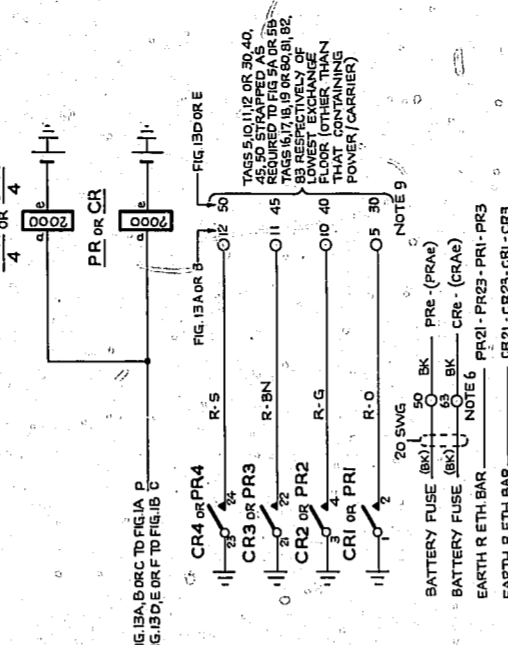
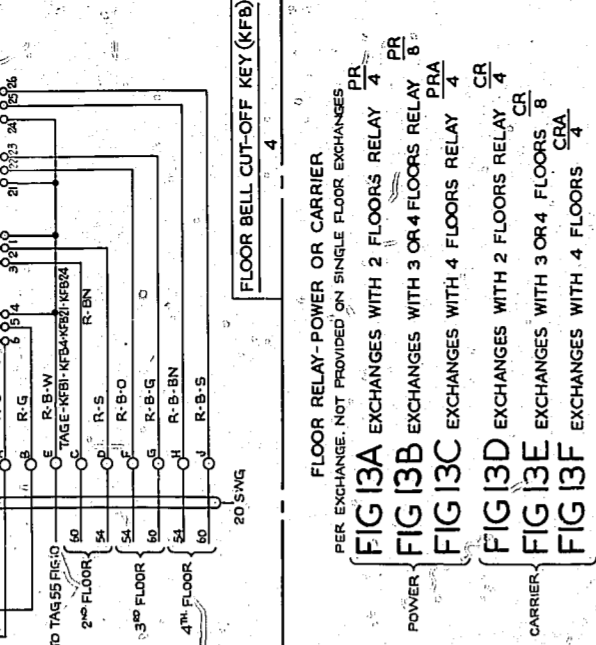
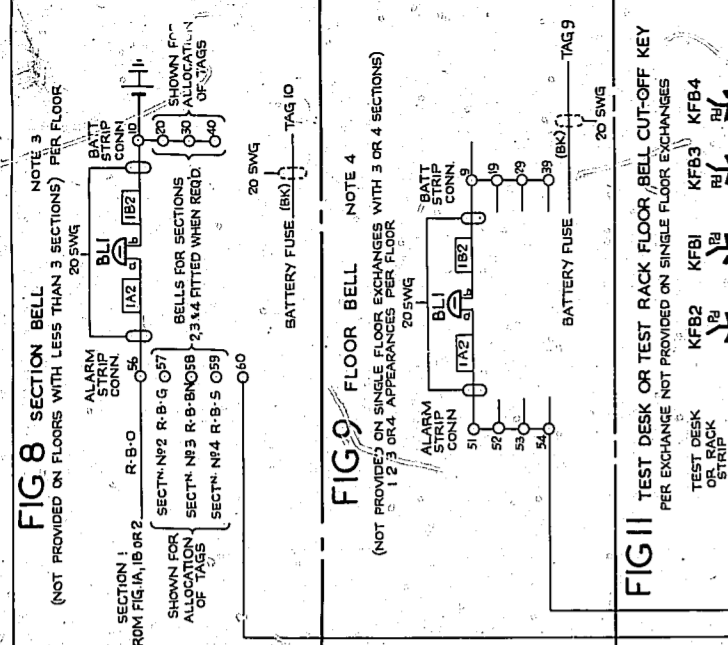
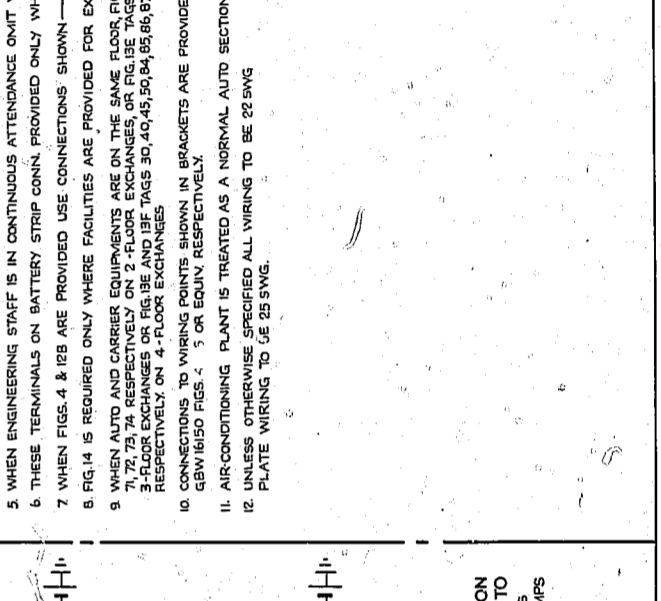
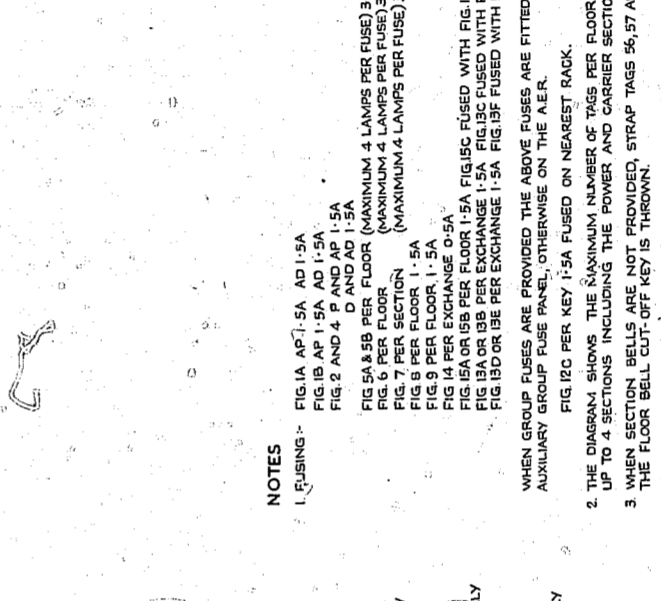
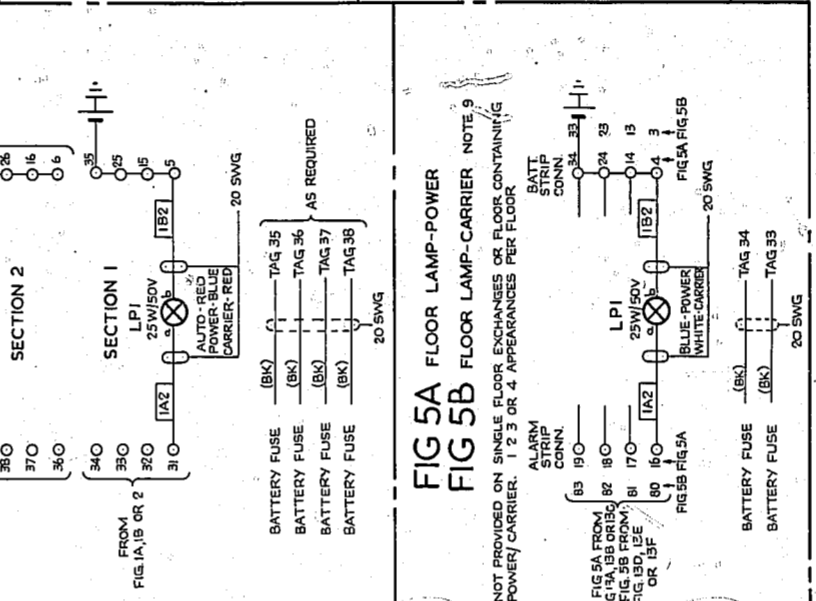
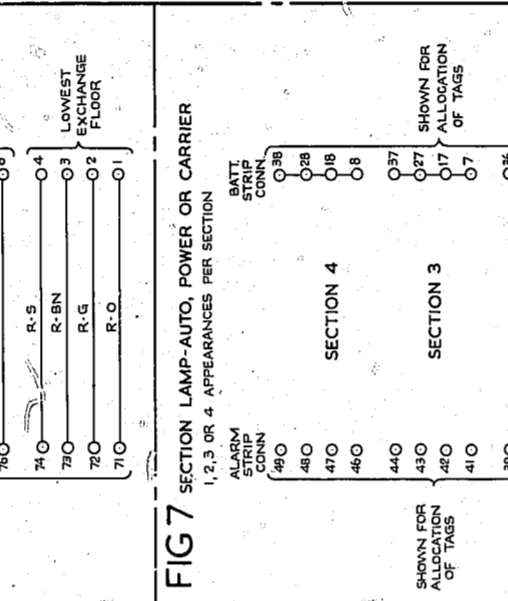
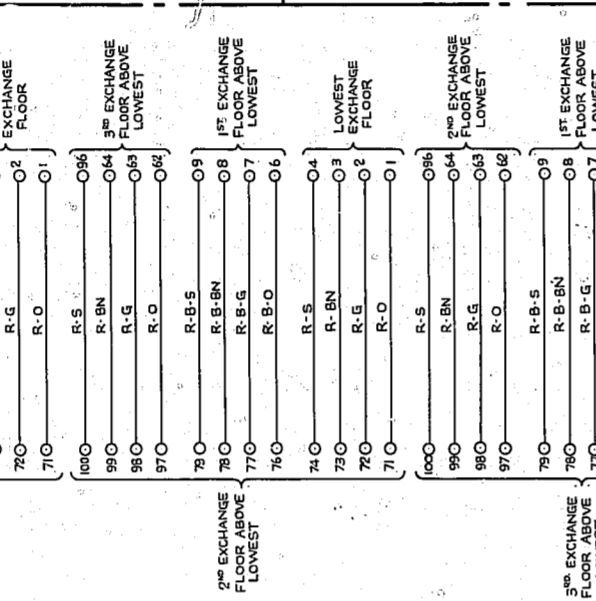
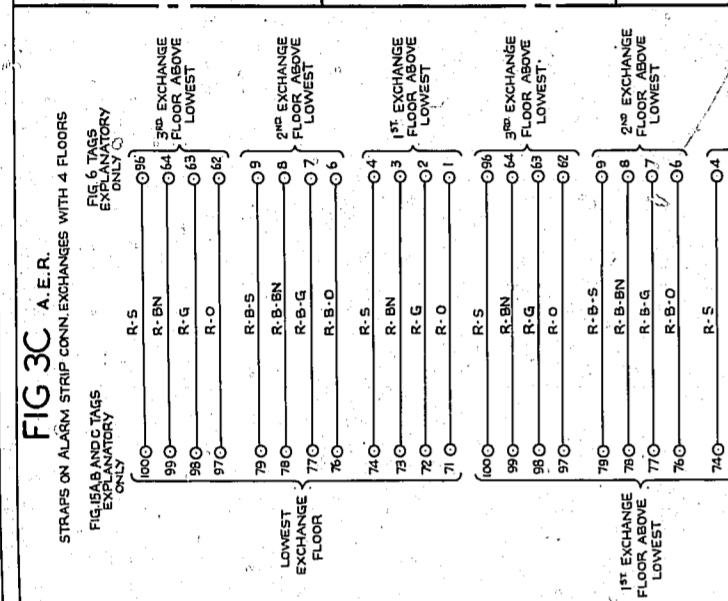
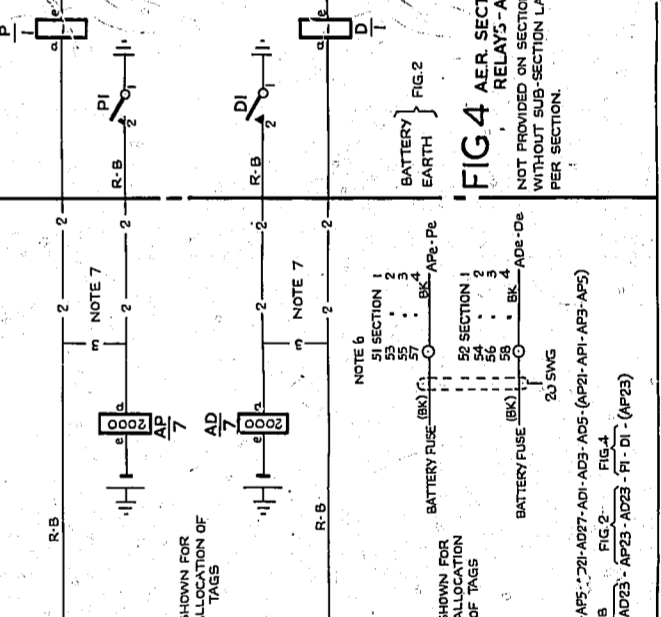
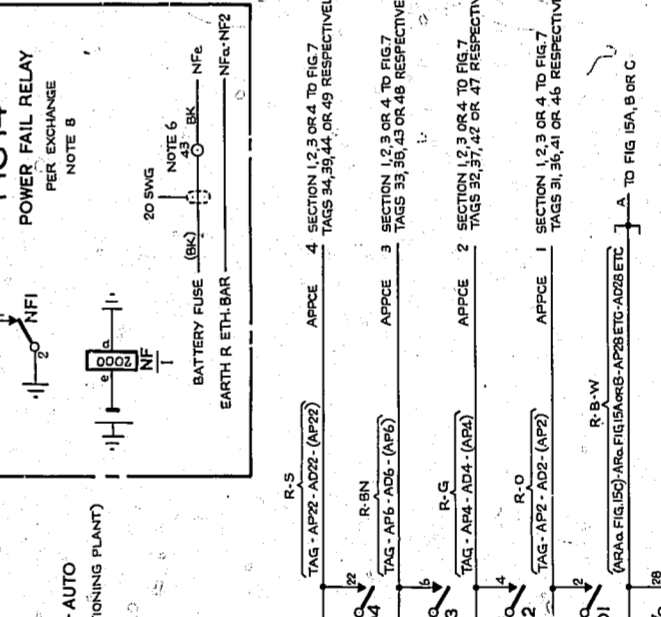
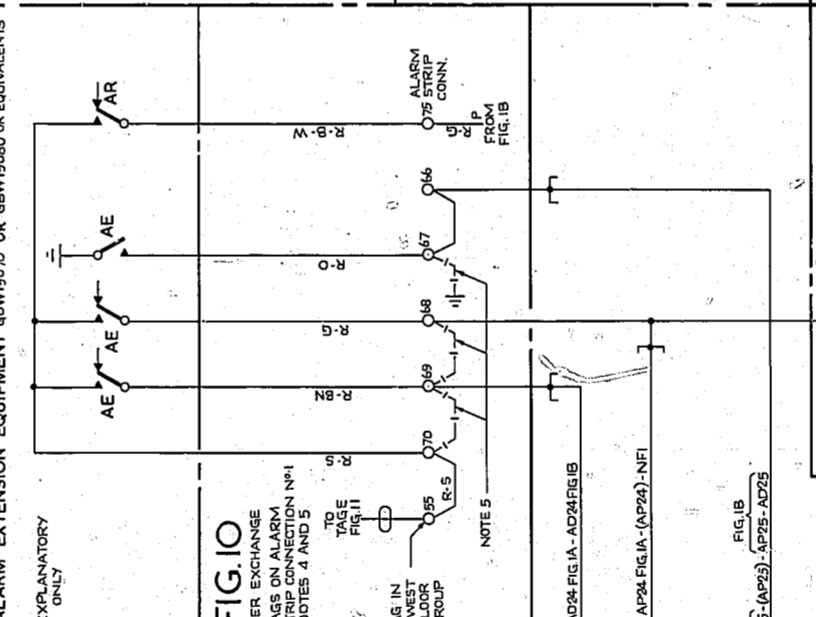
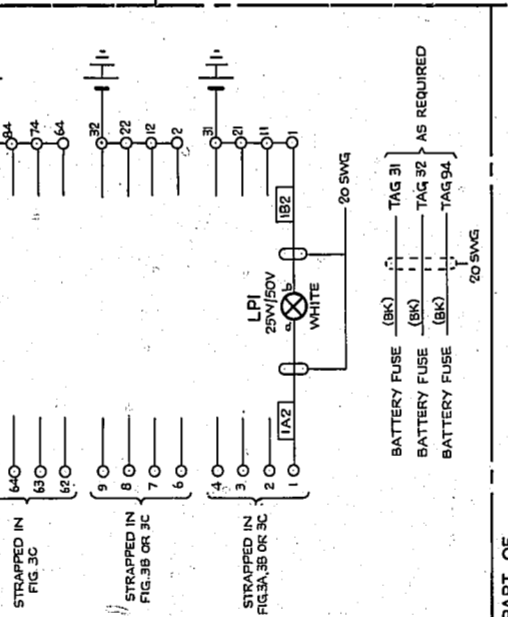
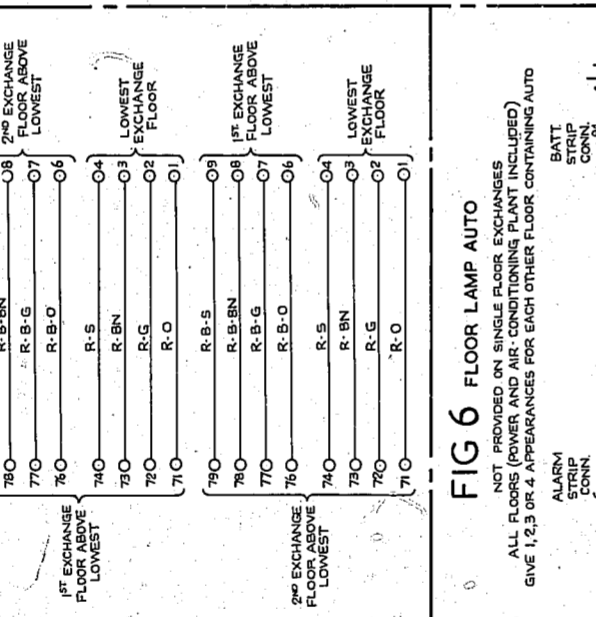
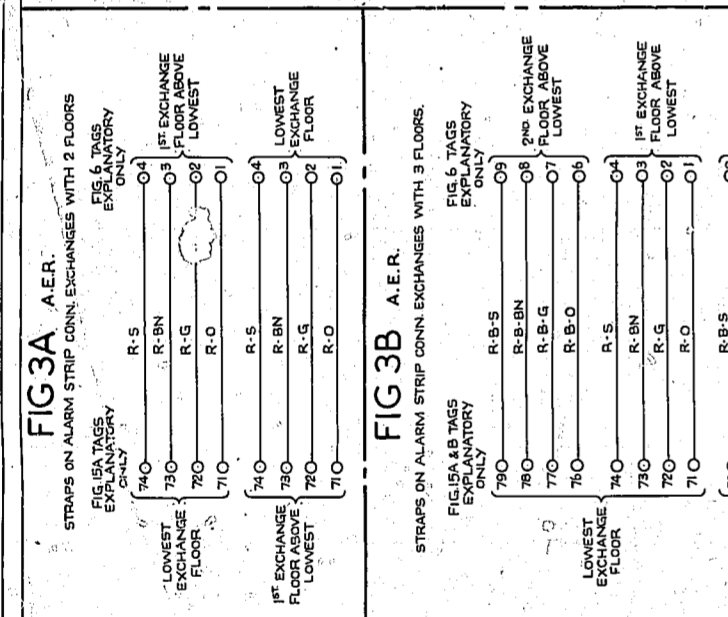
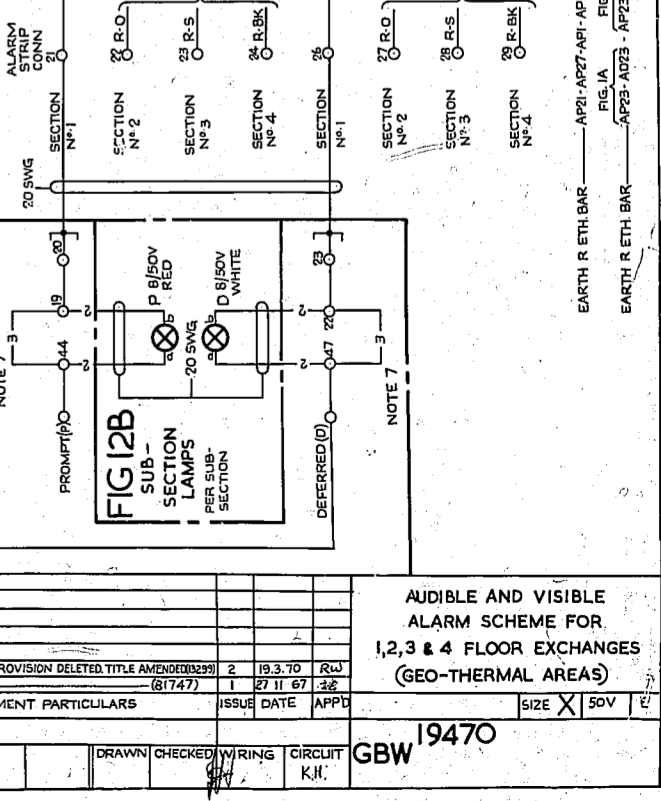
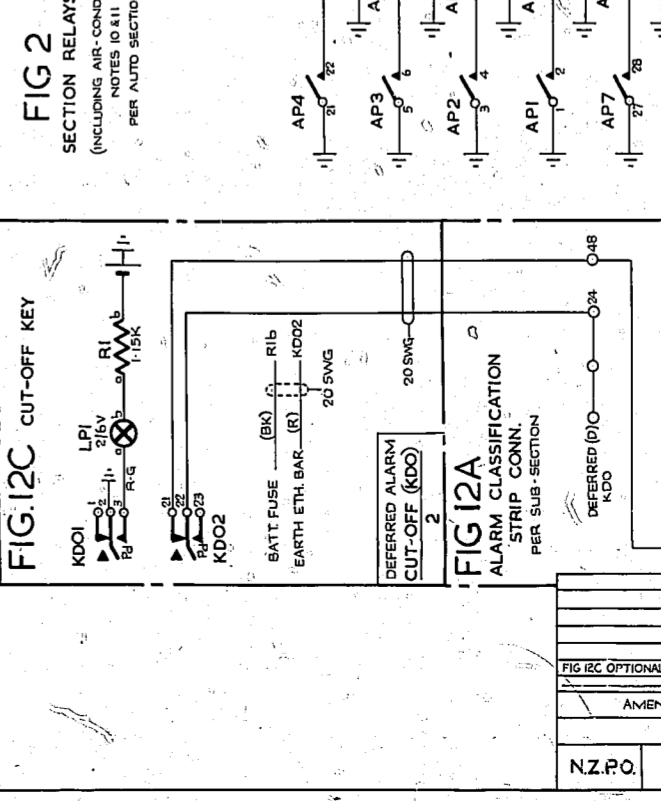
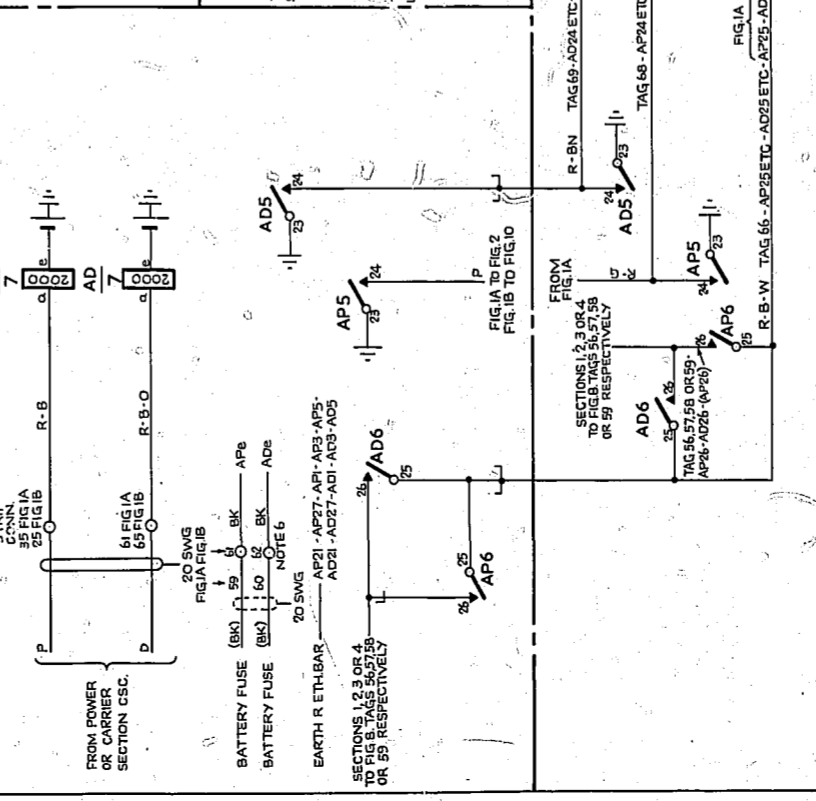
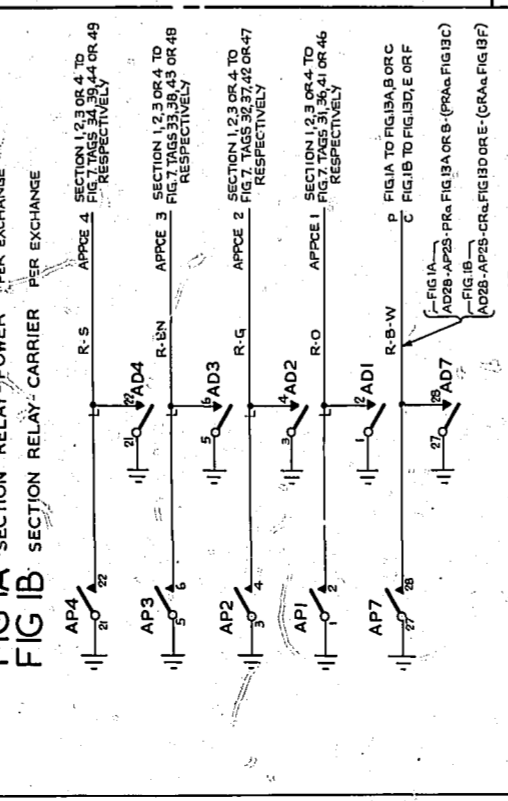
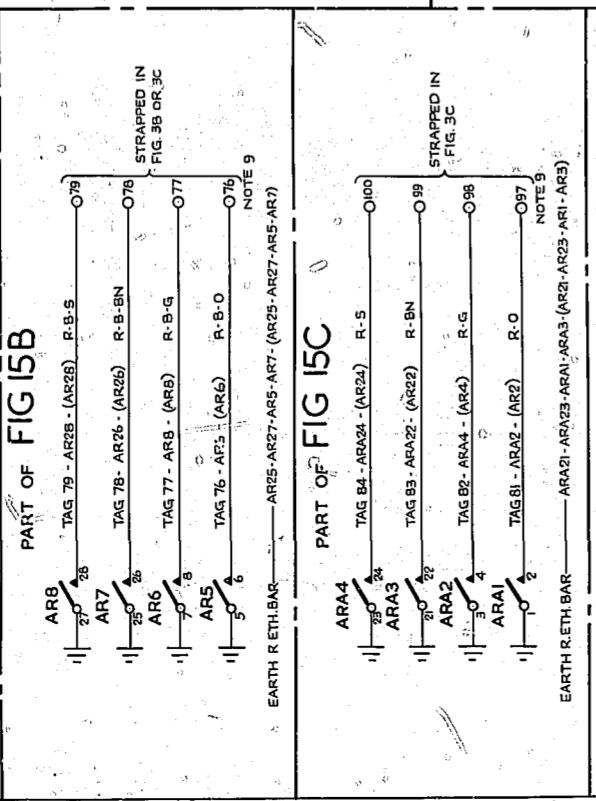
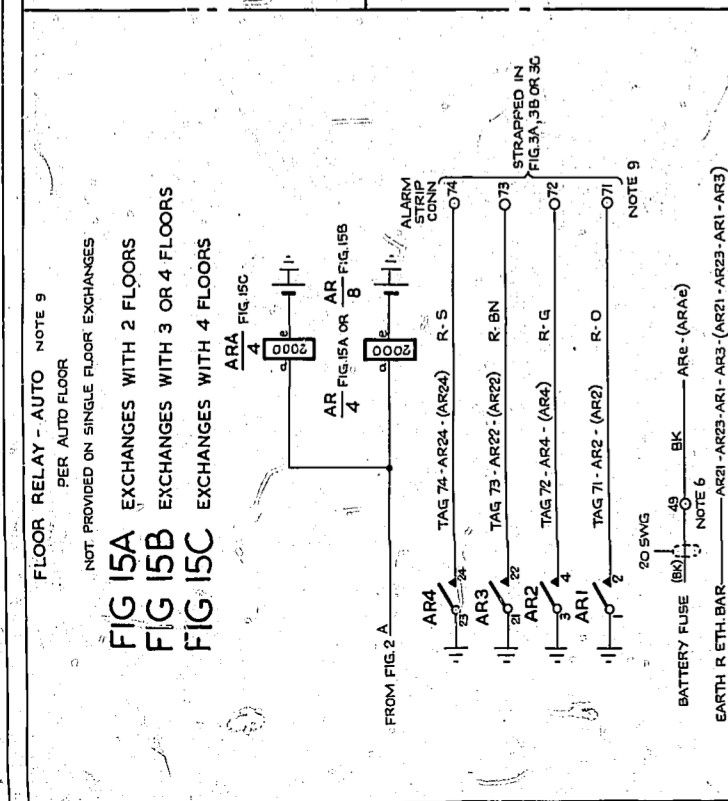

NOTES

1. UNLESS OTHERWISE SPECIFIED ALL WIRING TO BE 20 SWG.
2. UNLESS OTHERWISE SPECIFIED ALL WIRING TO BE 20 SWG.
3. UNLESS OTHERWISE SPECIFIED ALL WIRING TO BE 20 SWG.
4. UNLESS OTHERWISE SPECIFIED ALL WIRING TO BE 20 SWG.
5. UNLESS OTHERWISE SPECIFIED ALL WIRING TO BE 20 SWG.
6. UNLESS OTHERWISE SPECIFIED ALL WIRING TO BE 20 SWG.
7. UNLESS OTHERWISE SPECIFIED ALL WIRING TO BE 20 SWG.
8. UNLESS OTHERWISE SPECIFIED ALL WIRING TO BE 20 SWG.
9. UNLESS OTHERWISE SPECIFIED ALL WIRING TO BE 20 SWG.
10. UNLESS OTHERWISE SPECIFIED ALL WIRING TO BE 20 SWG.
11. UNLESS OTHERWISE SPECIFIED ALL WIRING TO BE 20 SWG.
12. UNLESS OTHERWISE SPECIFIED ALL WIRING TO BE 20 SWG.

AUDIBLE AND VISIBLE ALARM SCHEME FOR 1, 2, 3 & 4 FLOOR EXCHANGES (GEO-THERMAL AREAS)

AMENDMENT PARTICULARS		ISSUE DATE	APPD	SIZE
		18.3.70		1/1
		27.11.67		1/1

N.Z.P.O. DRAWN BY: K.H. CHECKED BY: WIRING CIRCUIT: GBW 19470