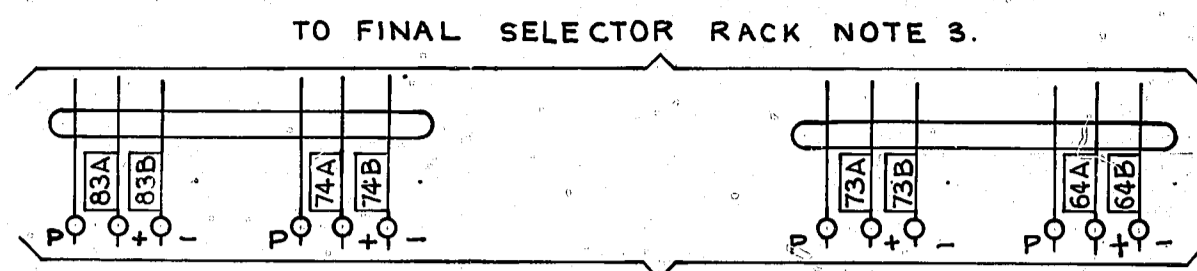
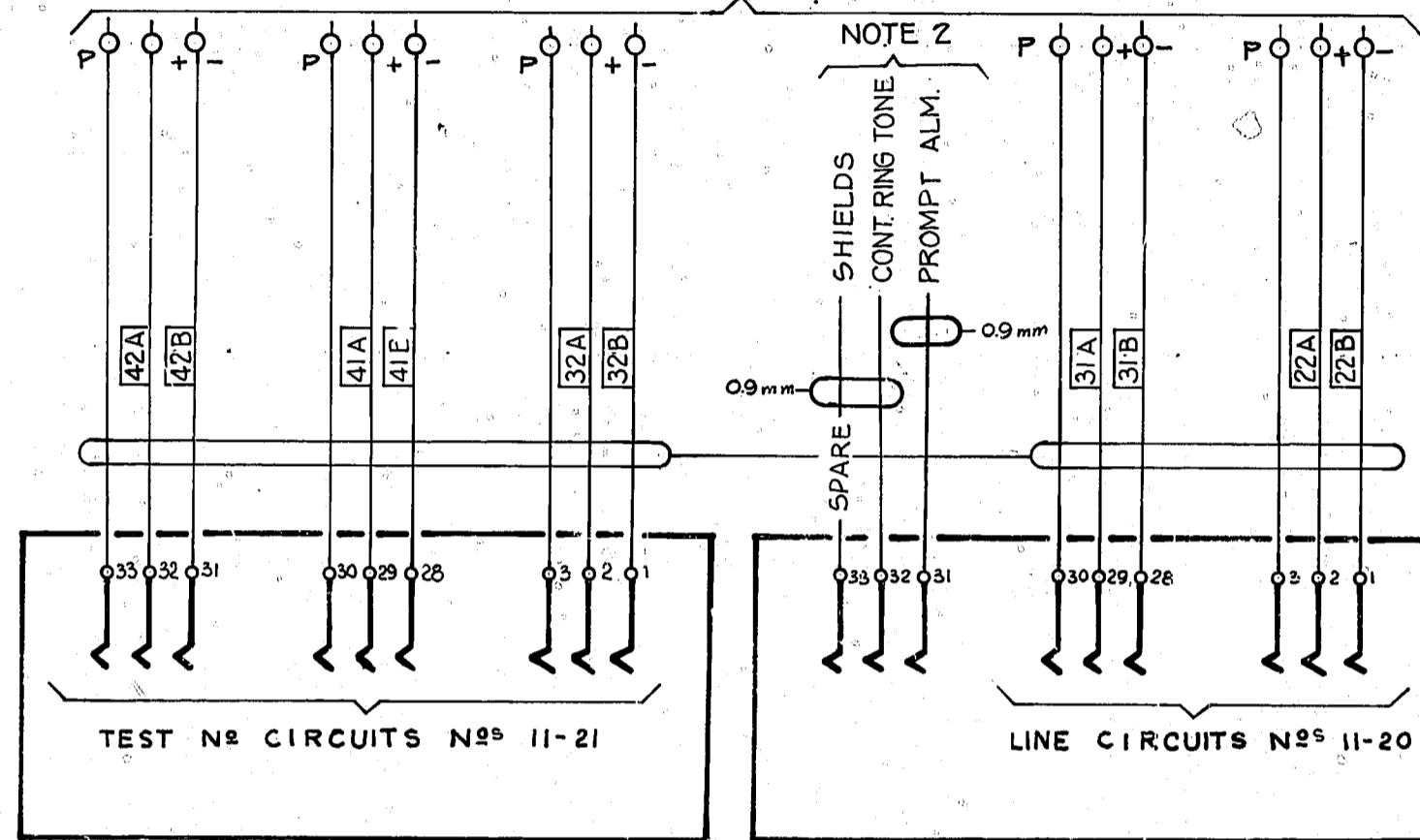

FIG. IC. 2ND THOUSAND NUMBERS



JUMPER TO FIG. IA TAGS AS REQD.
JUMPER TO FIG. IC TAGS AS REQD.



AJD

AJB

FIG. IE. ONE PER EXCHANGE

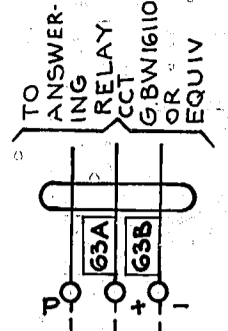

JUMPER TO FIG. IA TAGS AS REQD.
JUMPER TO FIG. IE TAGS AS REQD.

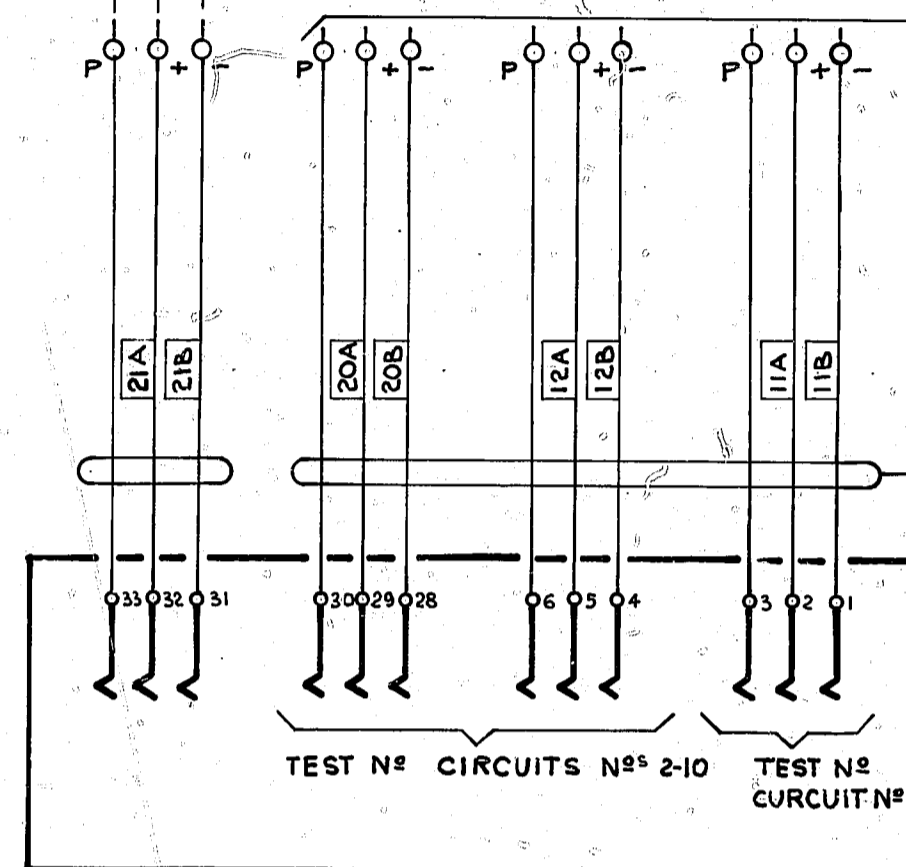

AJC

FIG. IB. 1ST THOUSAND NUMBER

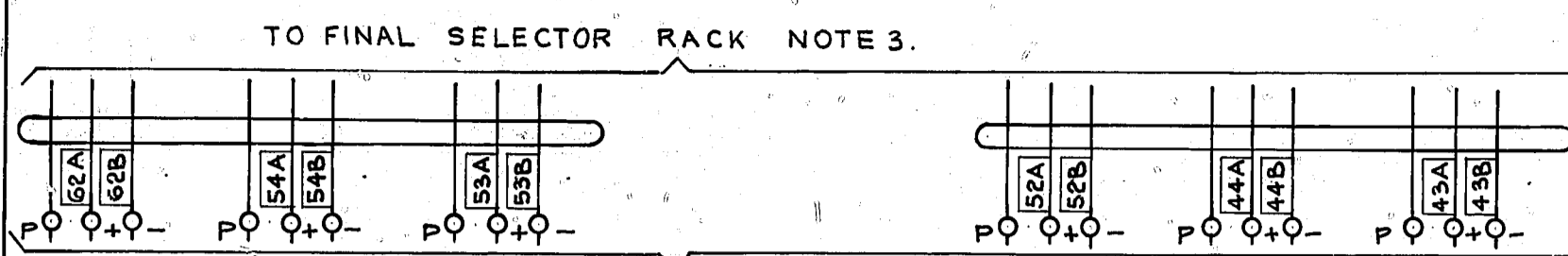

M.D.F. EXCH OR EXCH OR L.D.F. LOC. OR MULT AS SPECIFIED

FIG. IA. ONE PER EXCHANGE

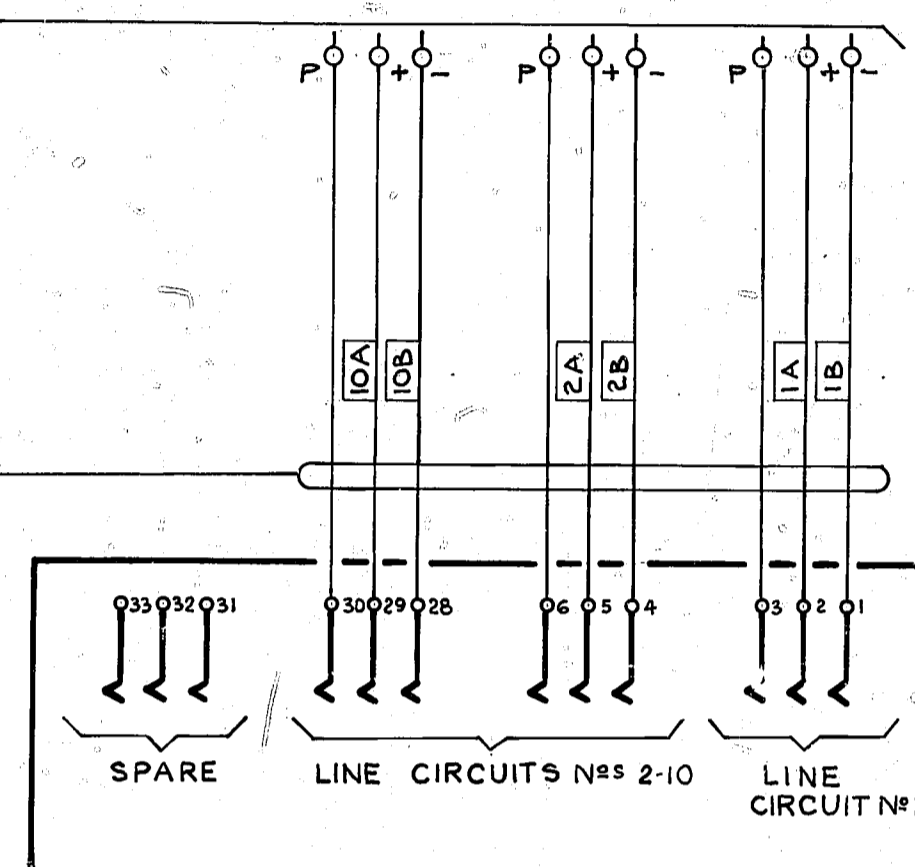

AJA

- NOTES:-
- FUSE:- FIG 3. 3A PER JACK BATTERY AND EARTH SUPPLIES ARE OBTAINED FROM NEAREST RACK WITH SPARE POSITIONS.
 - AJB/31 IS CONNECTED TO PROMPT ALARM TAG ON NEAREST RACK MISC. STRIP CONN SEE R.C.S. FOR RACK CONCERNED. AJB/32 IS CONNECTED TO CONT. RING TONE DIRECT FROM A.E.R. OR R.E.R.
 - PROVISION OF TIE CABLES BETWEEN FINAL SELECTOR RACKS AND I.D.F. OR M.D.F. MAY BE AS FOLLOWS:-
(a) TWO 30W CABLES PER 1000 NOS TERMINATED ON THE 2ND & 4TH U.S/F.S RACK IN A 6 RACK ROW.
OR (b) OWN 60W CABLE PER 1000 NOS TERMINATED ON EITHER FINAL SELECTOR RACK IN A ROW CONTAINING ONLY TO FINAL SELECTOR RACKS.
OR (c) TWO 60W CABLES TO 1ST 1000 NOS IN A 6 RACK ROW AND MULTIPLE TO ALL OTHER 1000 NUMBER GROUPS.
 - IN ALL CASES THE CABLES SHOULD TERMINATE ON THE RACKS WHICH ALLOW BEST ACCESS FOR JUMPING TO ANY LINE CIRCUITS OR TEST NO CIRCUITS WITHIN THE GROUP
 - THE LINE C.T. SHOULD BE MODIFIED BY DISCONNECTING THE HOMING ARC WIPER AND CONNECTING STRAP SHOWN THIS TO CONTACT 1 OF DI ARC. THIS WILL ALLOW FORWARD HOLDING ON THE P WIRE.

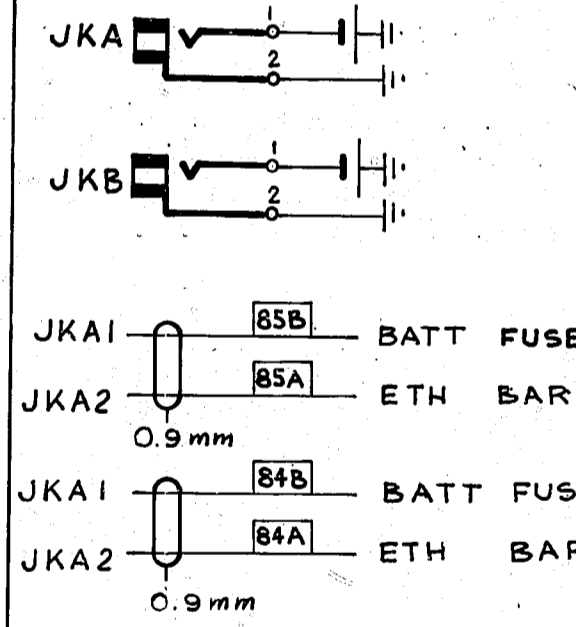

FIG. 3.

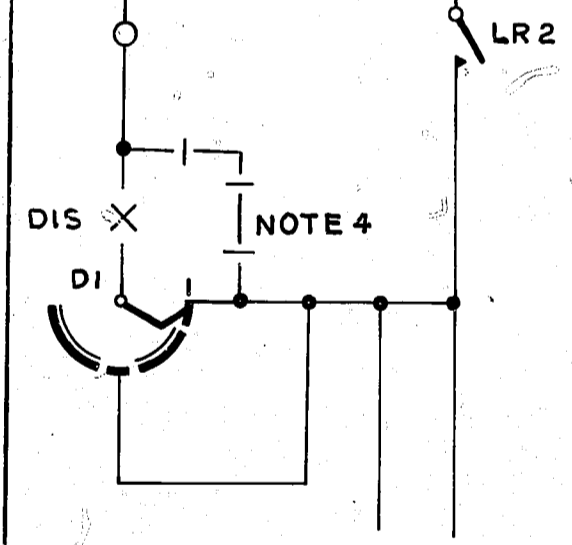
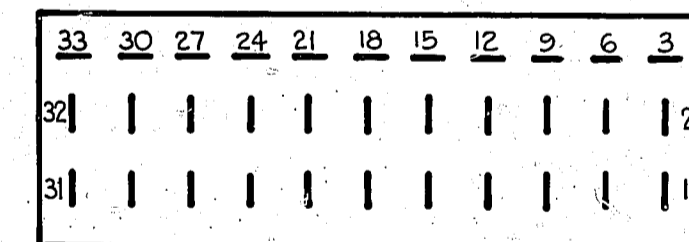
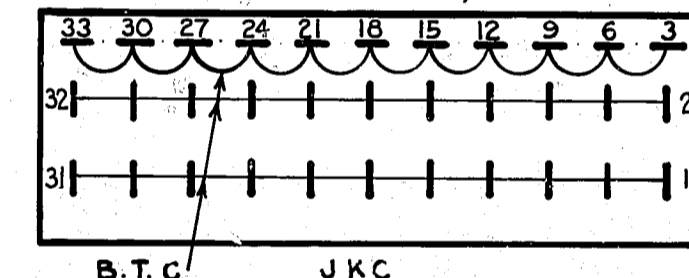

FIG. 2.
PART OF GBW 14790
OR EQUIV. NOTE 4

FIG. ID. REMOTE ANSWERING PLUG (FOR USE WITH JACK AJC)



EXPLANATORY ONLY
VIEW OF JACK N^o 79
(FROM WIRING SIDE)

PROOF

A	23.5.80	LN	17057	RETRACED FROM COY 155 2120.4.72					
I	30.10.80								
50V	S	ISS	DATE	DEL	DC	ORDER	CKD	APPD	CHANGE
DRN:T-EQPT		CKD		ORIGIN:T-EQPT					
TCD:L.N.		APPD		STANDARD:ATW 22001					
NZPO ENGINEER-IN-CHIEF WELLINGTON									
SHT OF 1		SIZE A2		GBW 16120					

PANEL ACCESS FOR
ARTIFICAL TRAFFIC
EQUIPMENT

UD 236

