

FIG. 1.
FUSE ALARM
1 PER UNIT "A" & "S"
1 PER 2 UNITS "B"

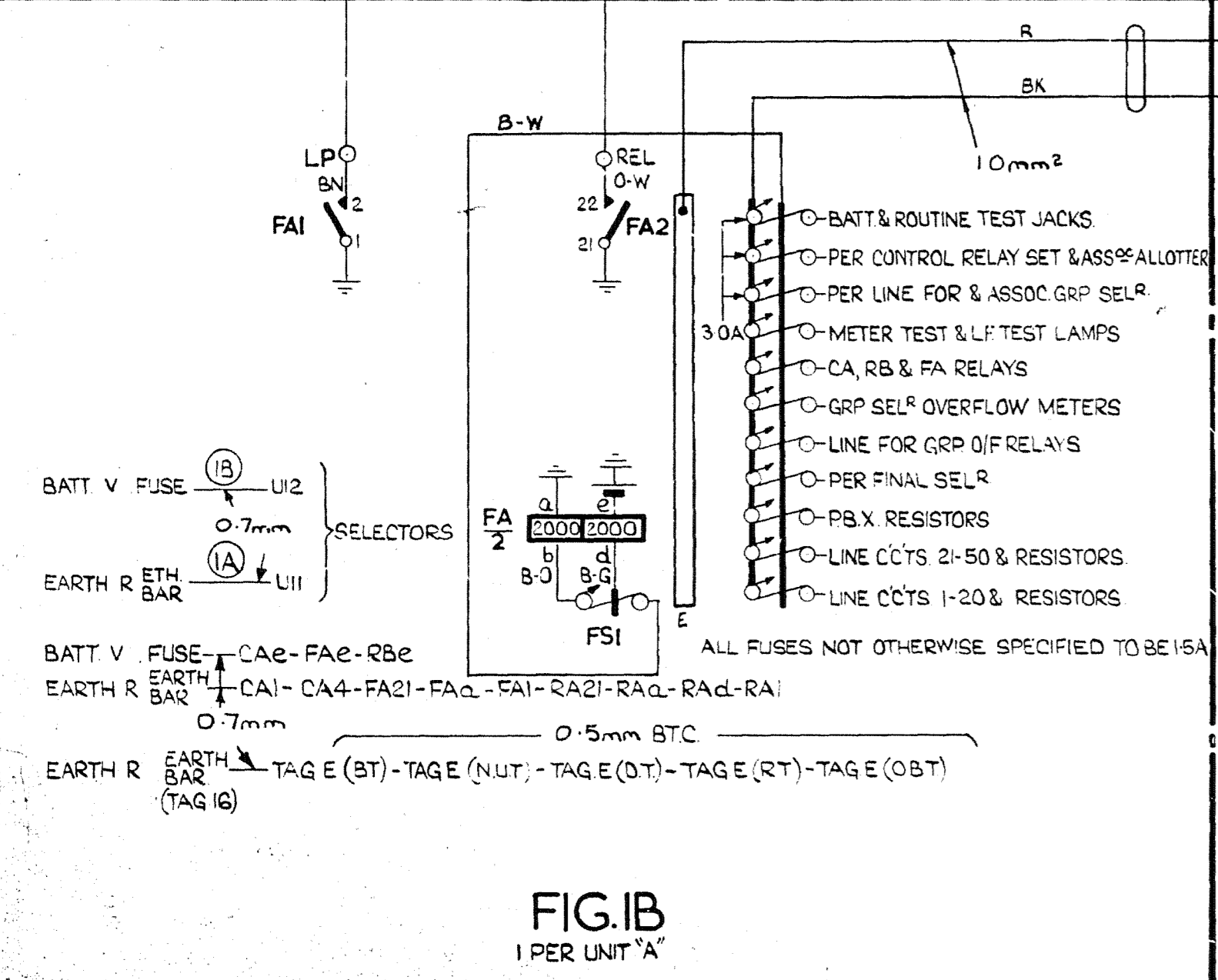
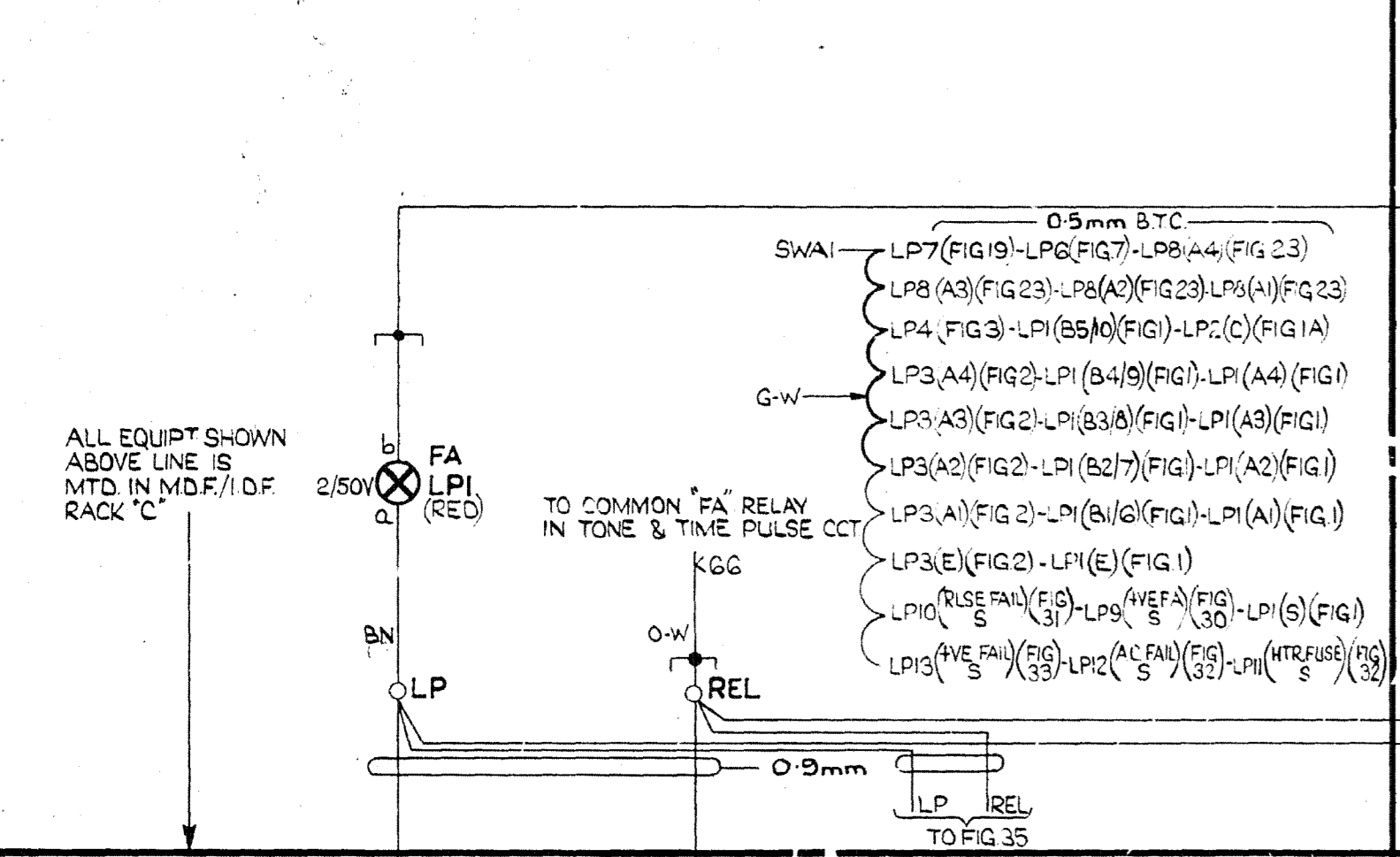

FIG. 1B
1 PER UNIT "A"

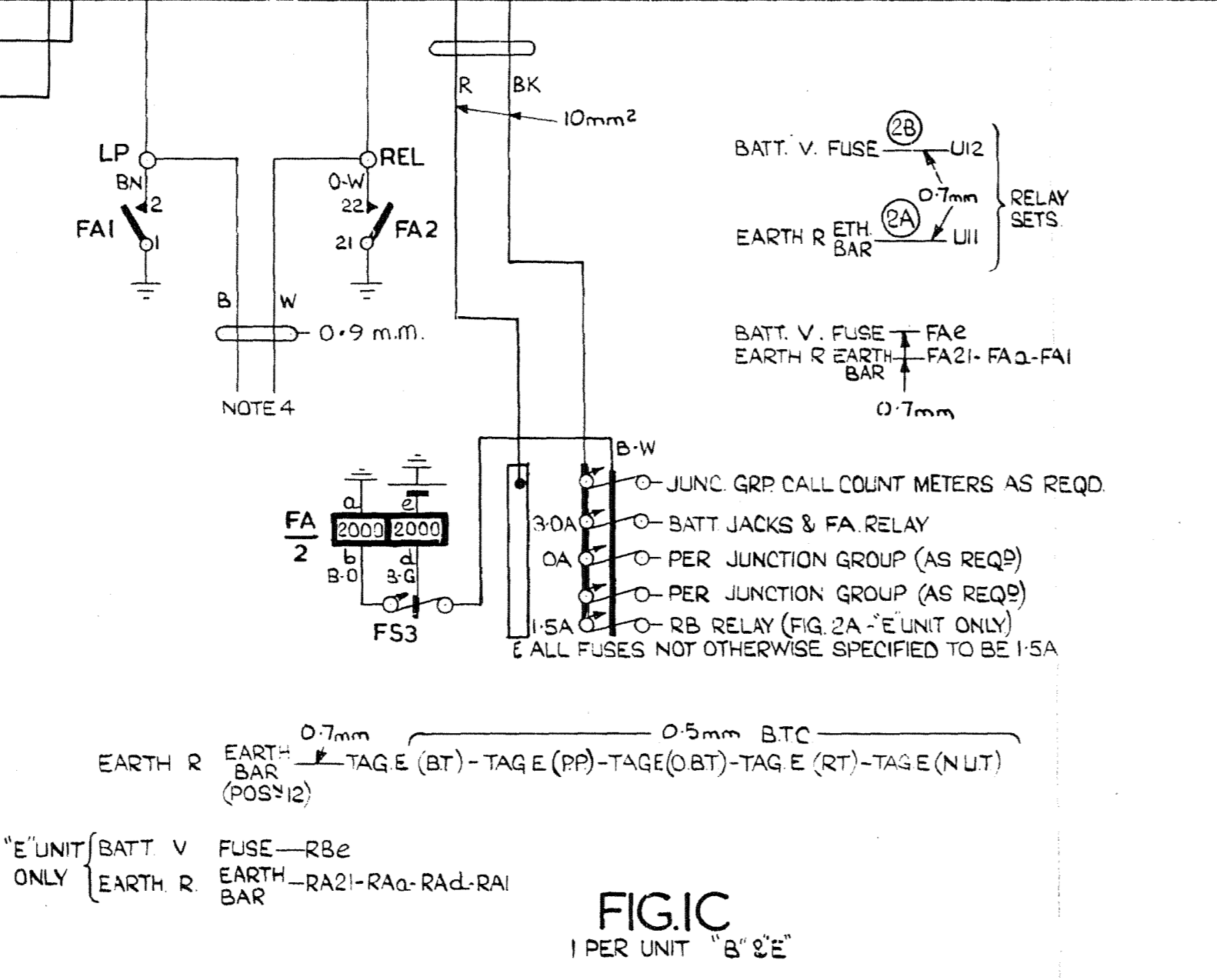
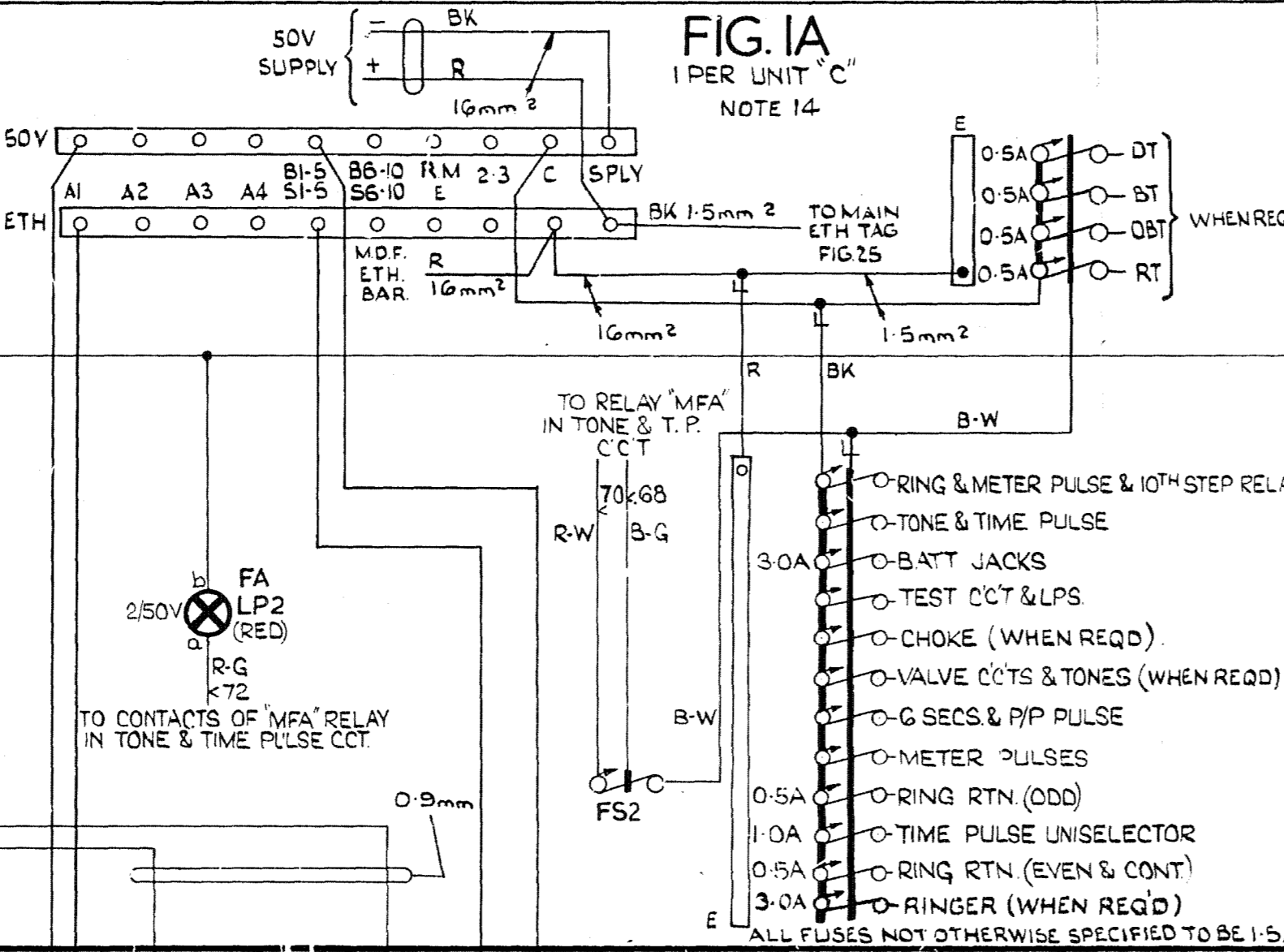

FIG. 1C
1 PER UNIT "B" & "E"

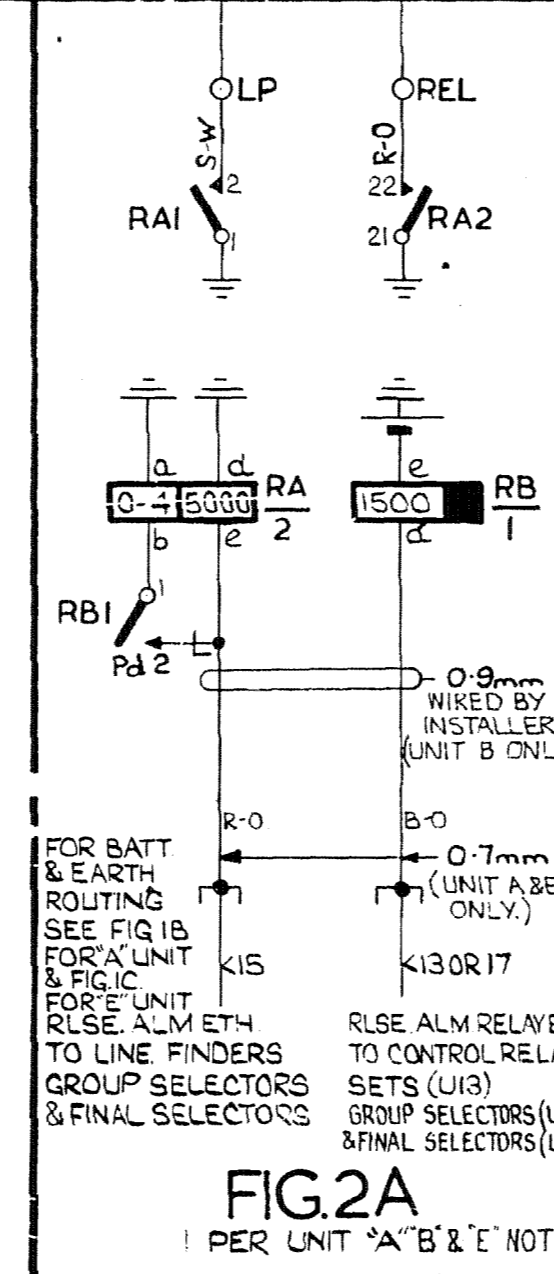
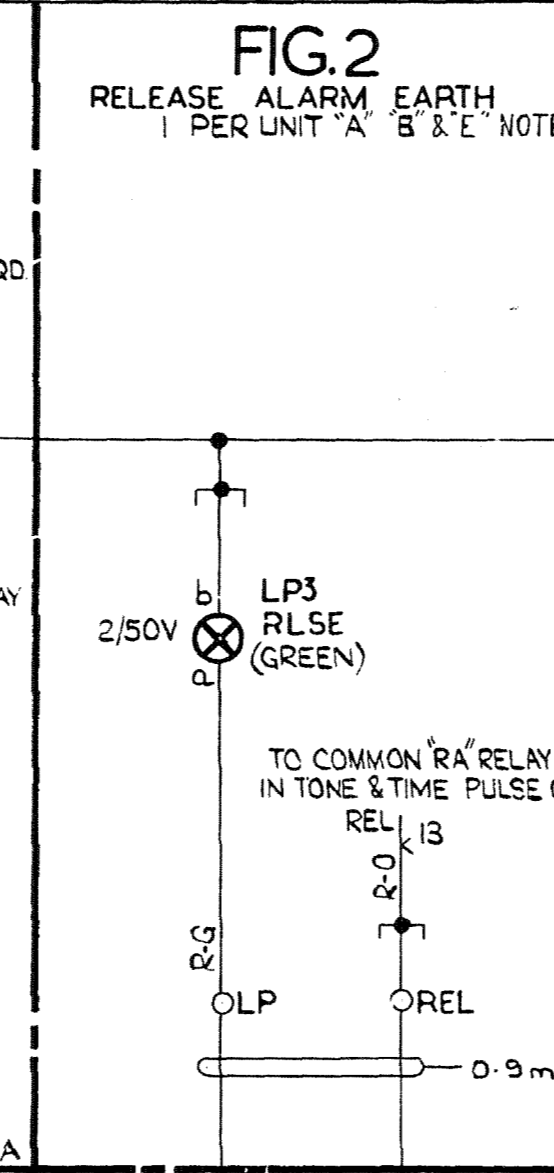

FIG. 2A
1 PER UNIT "A" "B" & "E" NOTE II

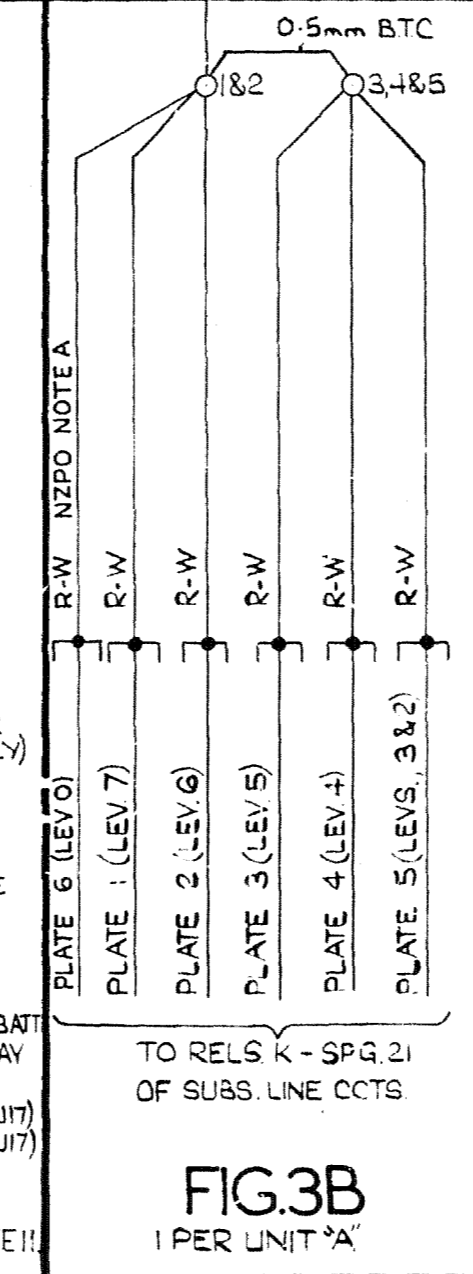
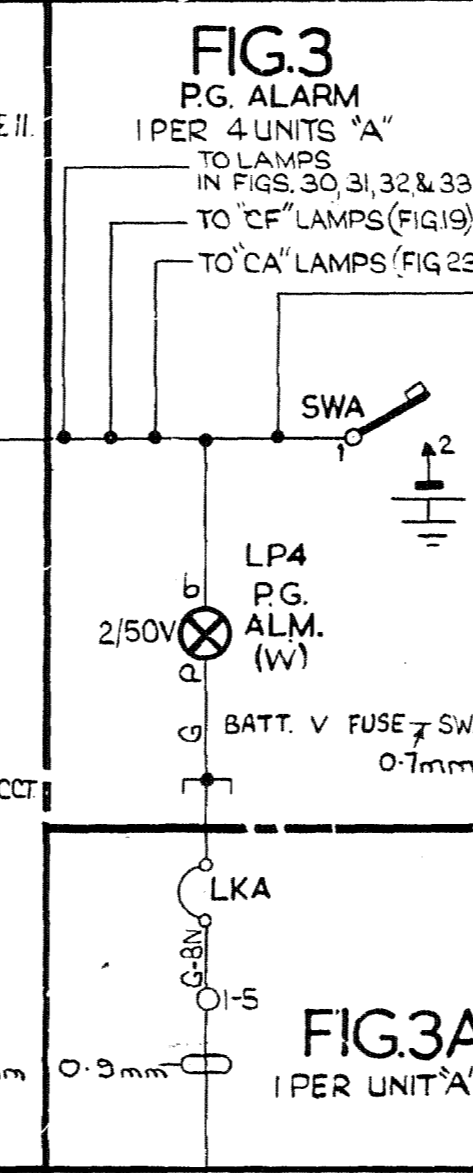

FIG. 3B
1 PER UNIT "A"

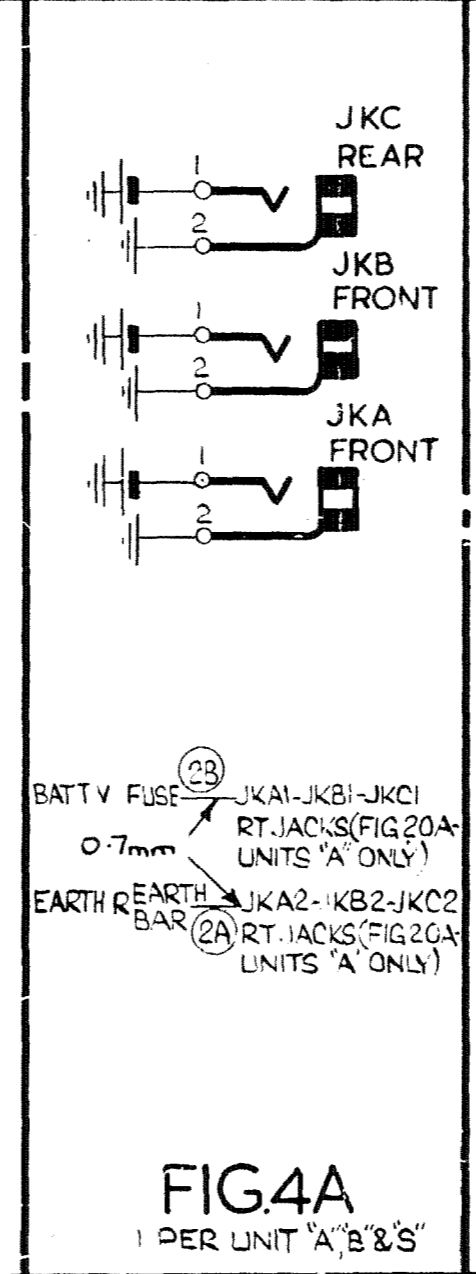
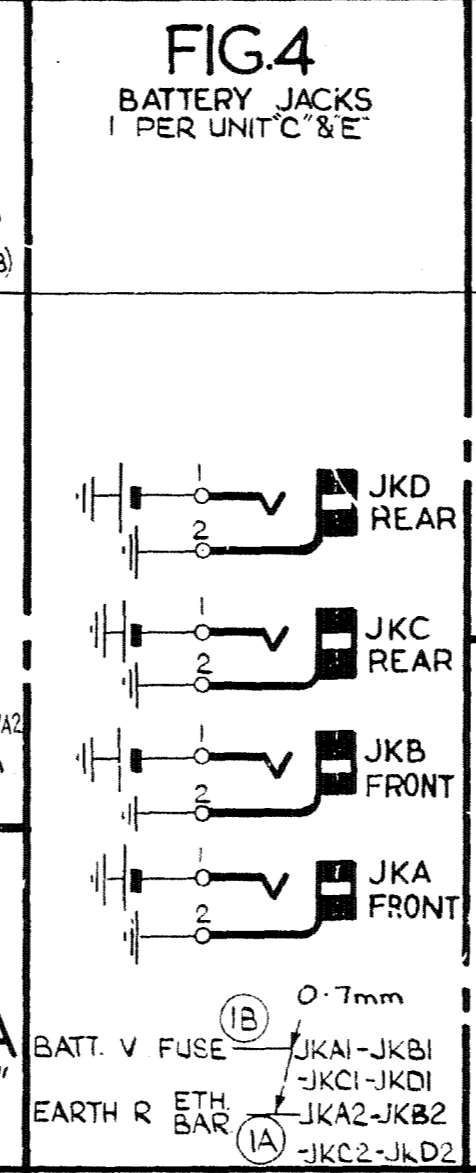

FIG. 4A
1 PER UNIT "A" "B" & "S"

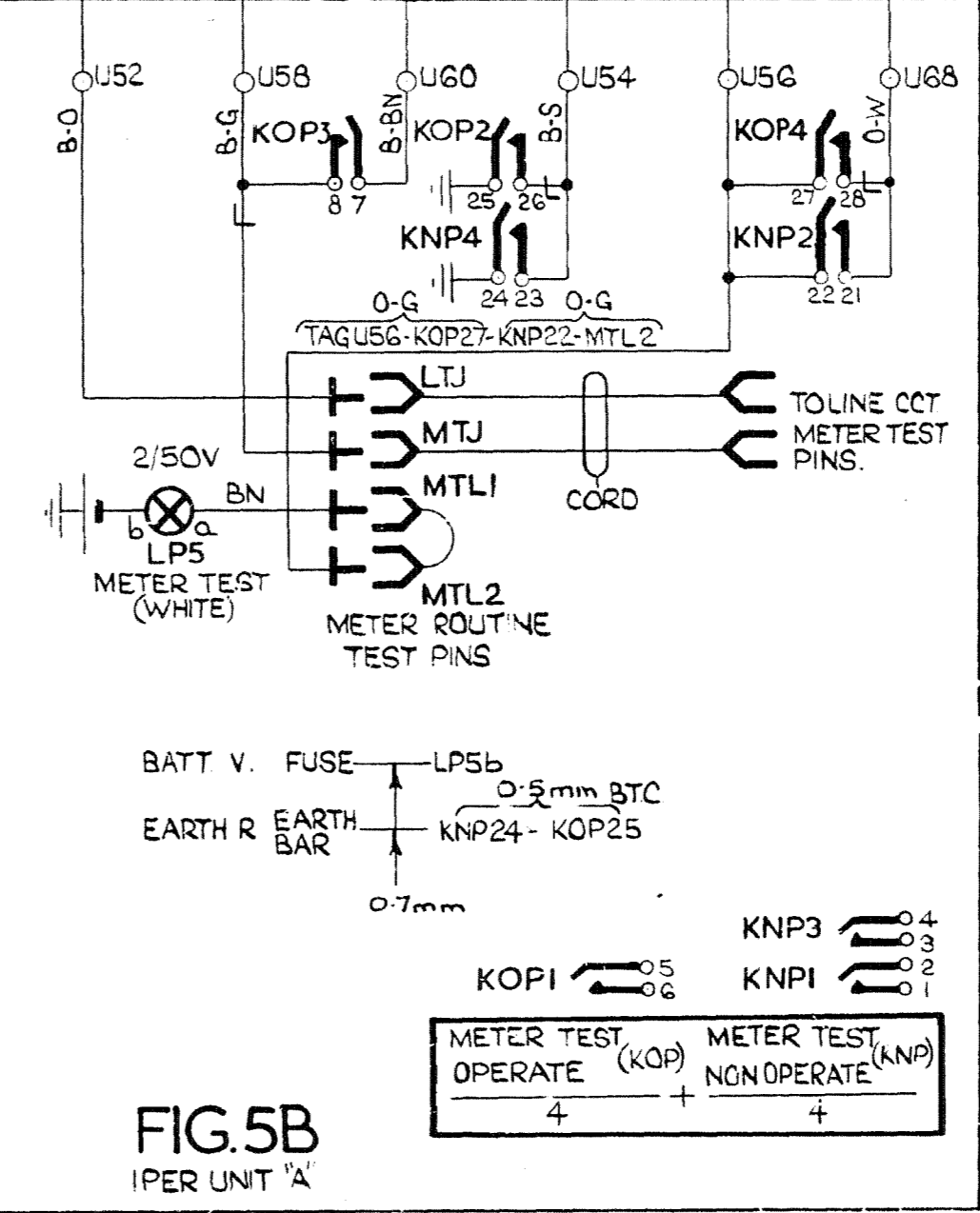
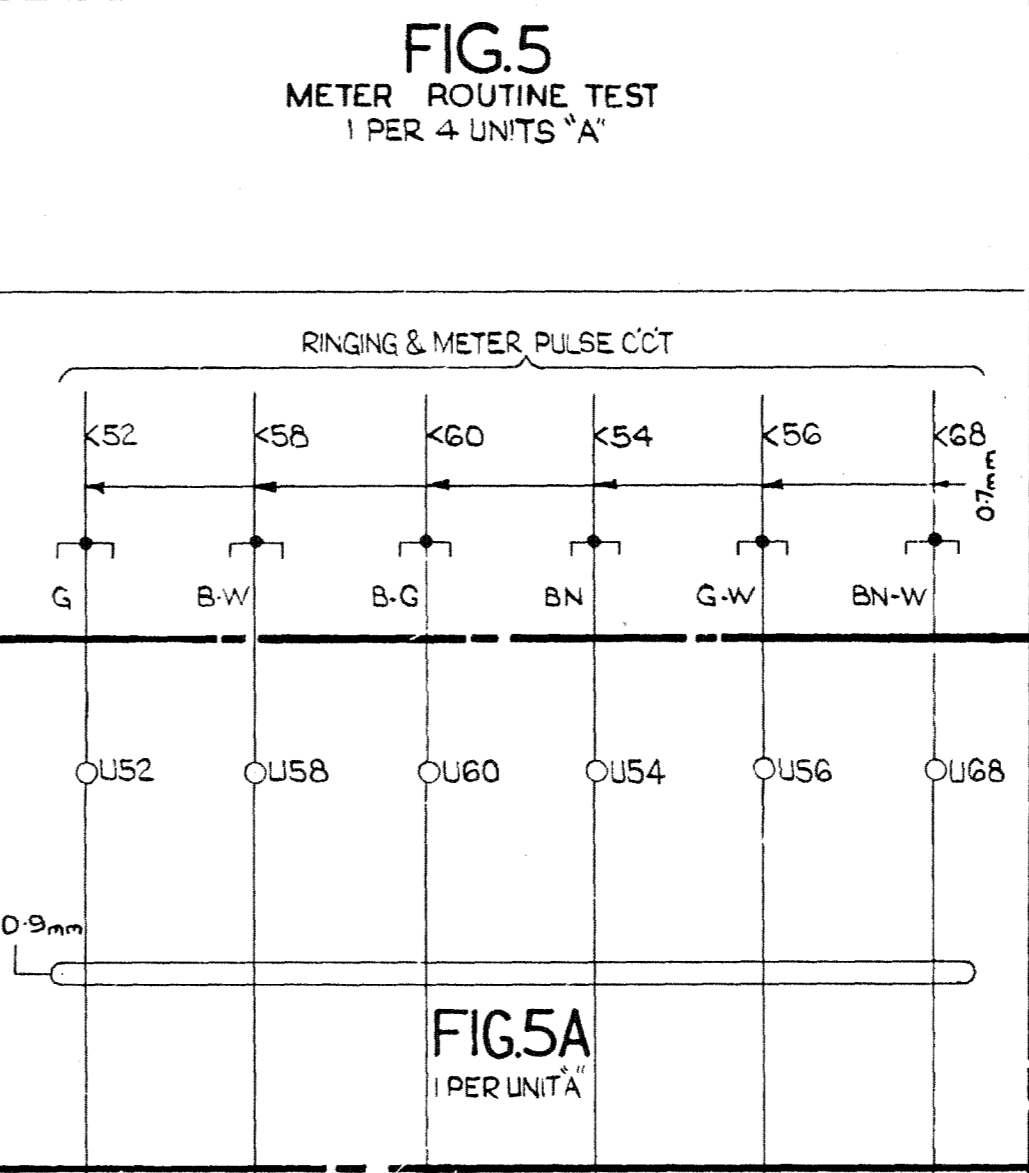

FIG. 5B
1 PER UNIT "A"

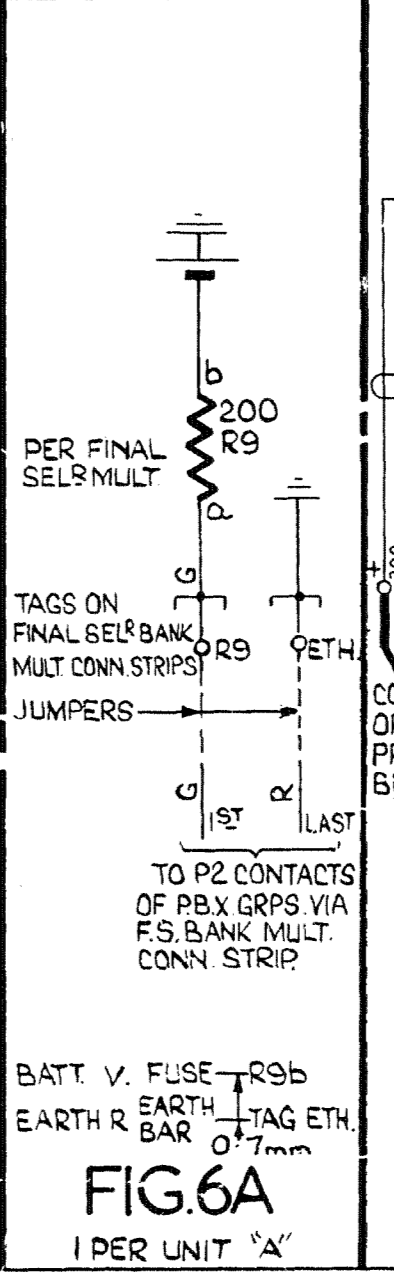
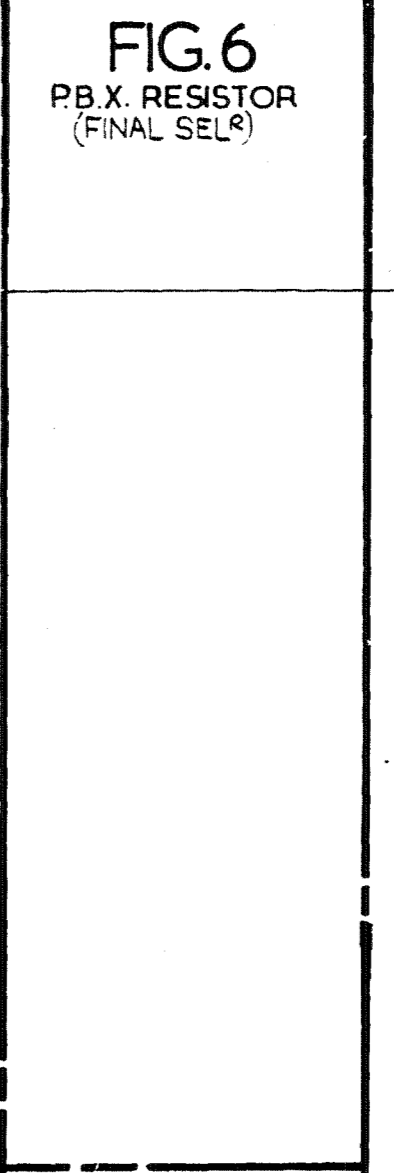

FIG. 6A
1 PER UNIT "A"

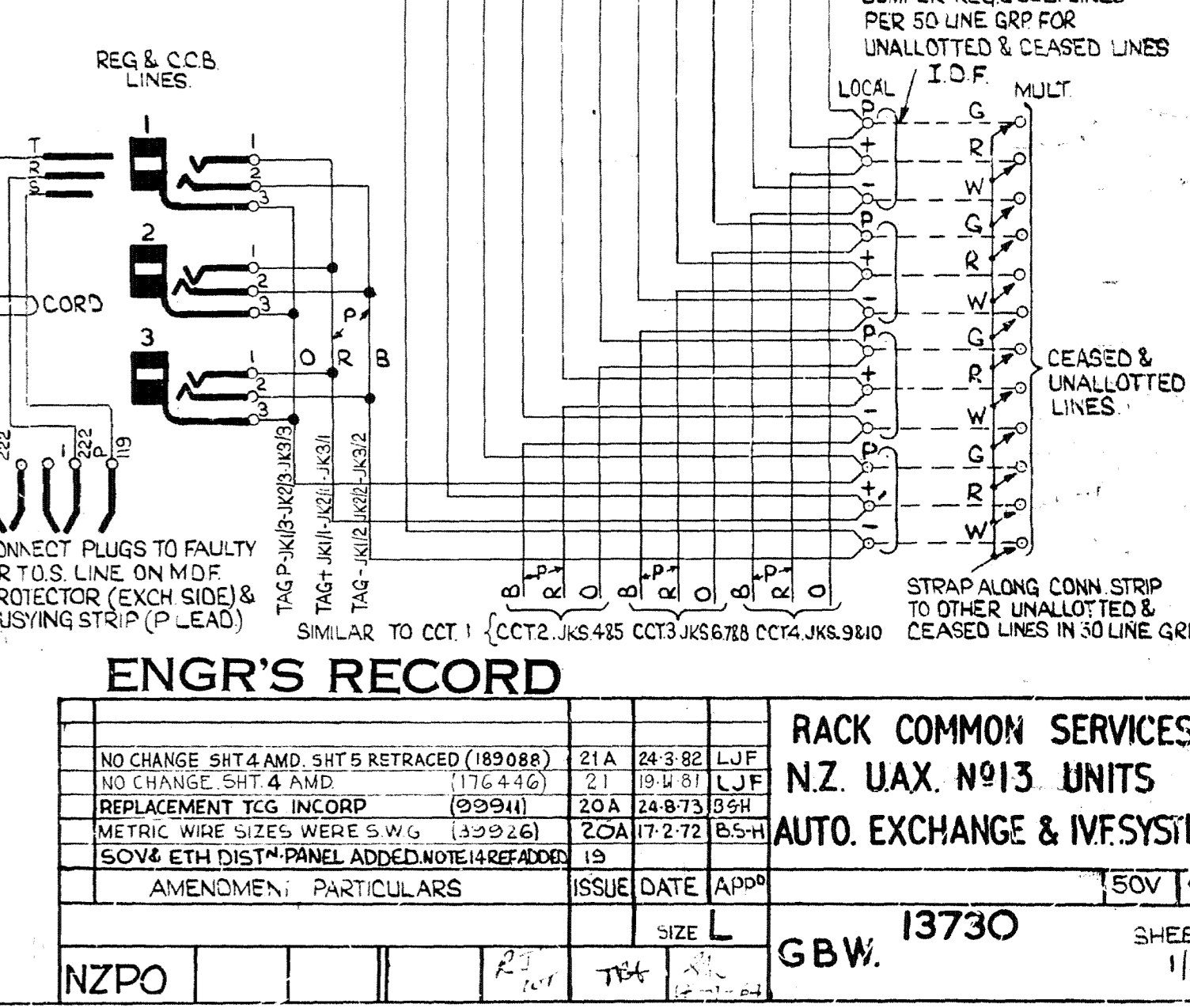
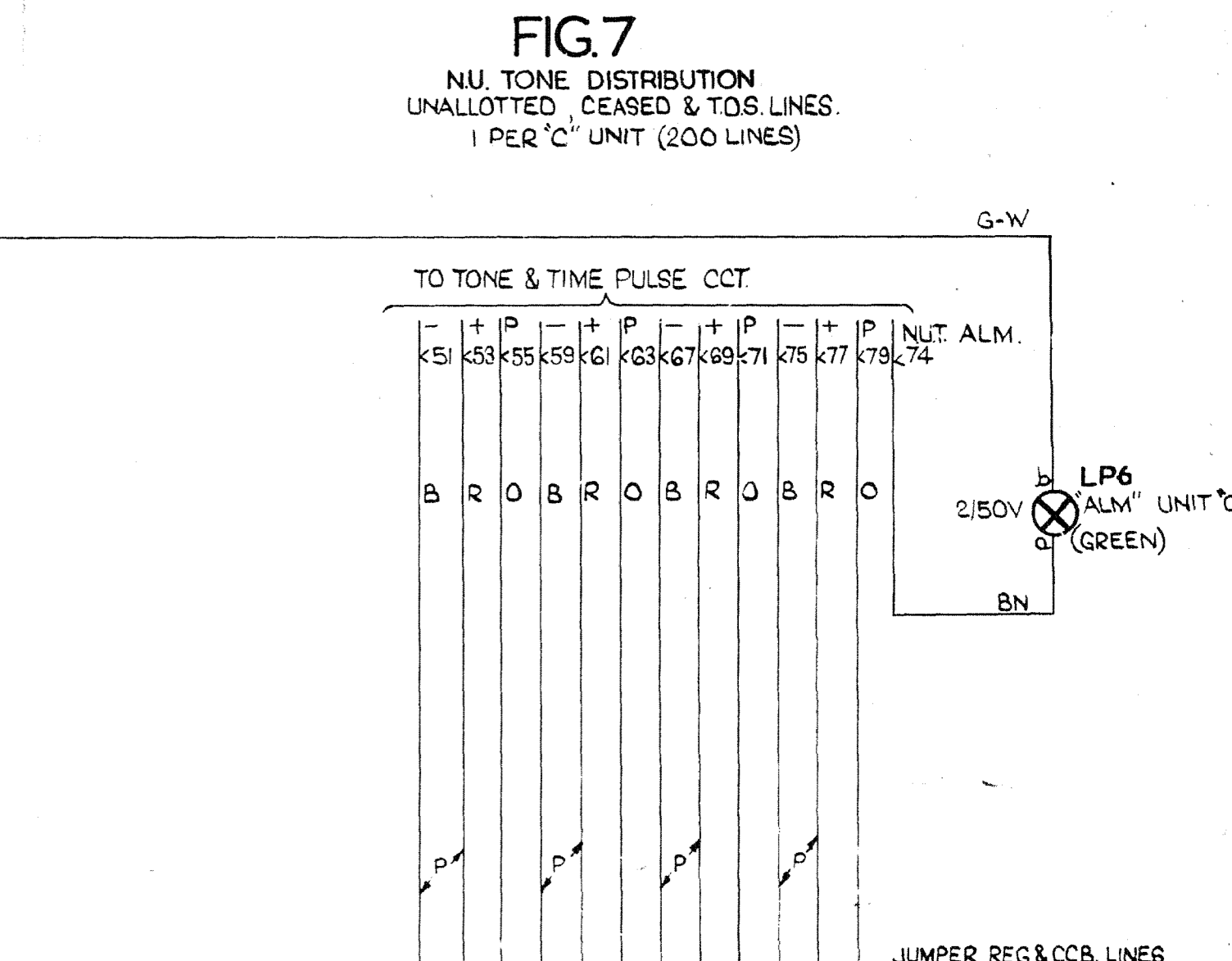

FIG. 7A
1 PER UNIT "C"

ENGR'S RECORD

NO CHANGE SHT 4 AMD. SHT 5 RETRACED (189088)	21A	24-3-82	LJF
NO CHANGE SHT 4 AMD	1176-4-46	21	19-4-81
REPLACEMENT TCG INCORP	(99941)	20A	24-8-73
METRIC WIRE SIZES WERE 5 W G	(39926)	20A	17-2-72
50V ETH DISTN PANEL ADDED (NOTE 14 REF ADDED)	19		
AMENDMENT PARTICULARS	ISSUE DATE	APPD	
	SIZE	L	
NZPO			

RACK COMMON SERVICES
N.Z. UAX. NO 13 UNITS
AUTO. EXCHANGE & IVF SYSTEM

GBW. 13730 SHEET 1/5

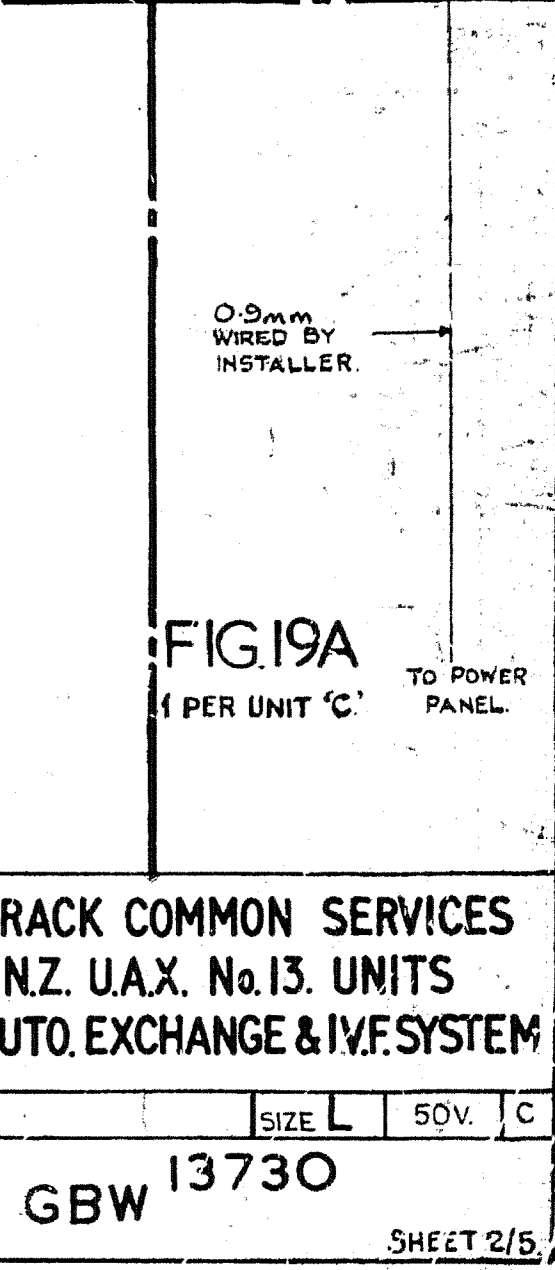
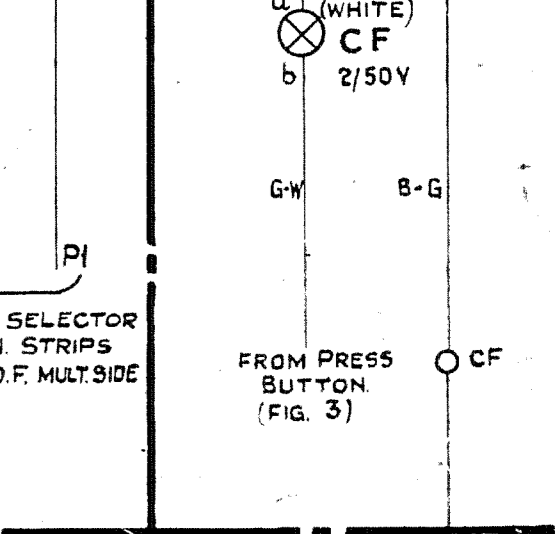
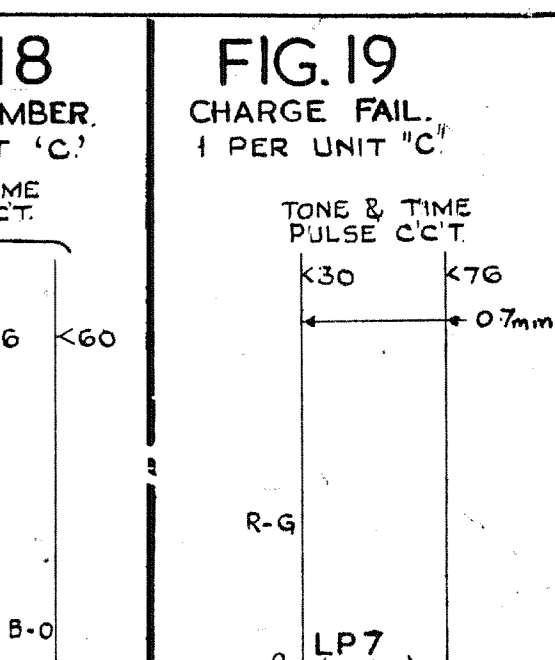
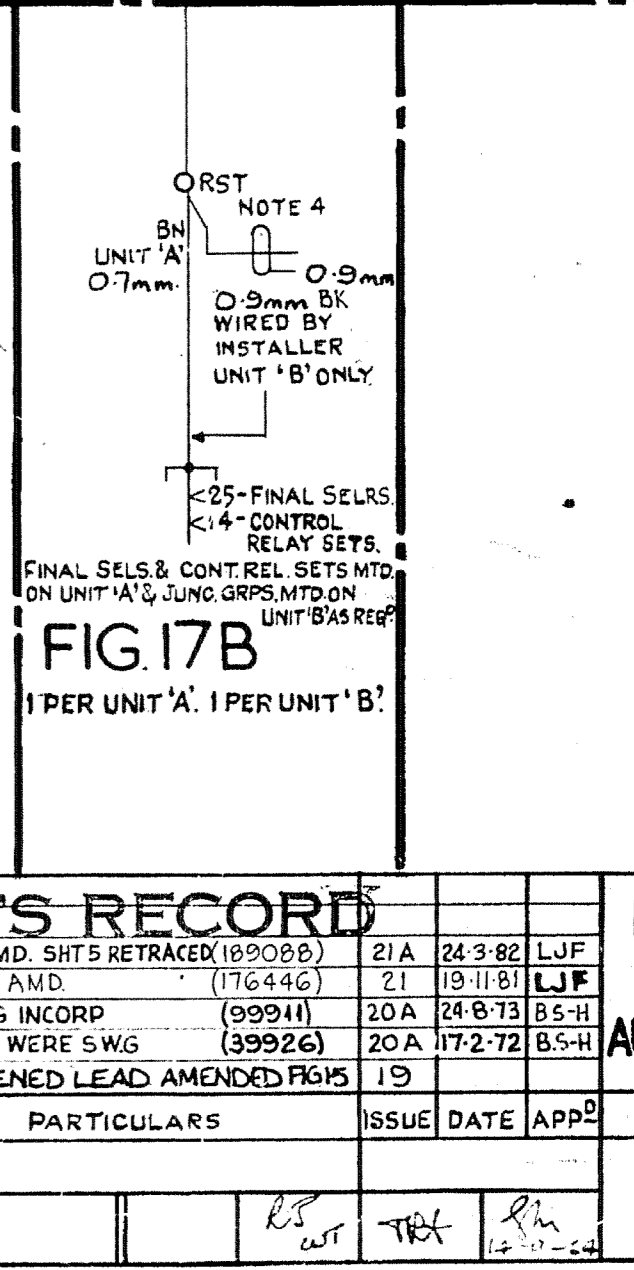
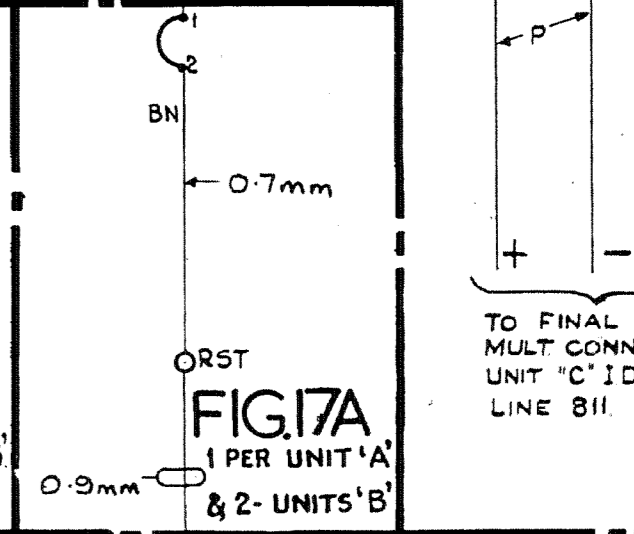
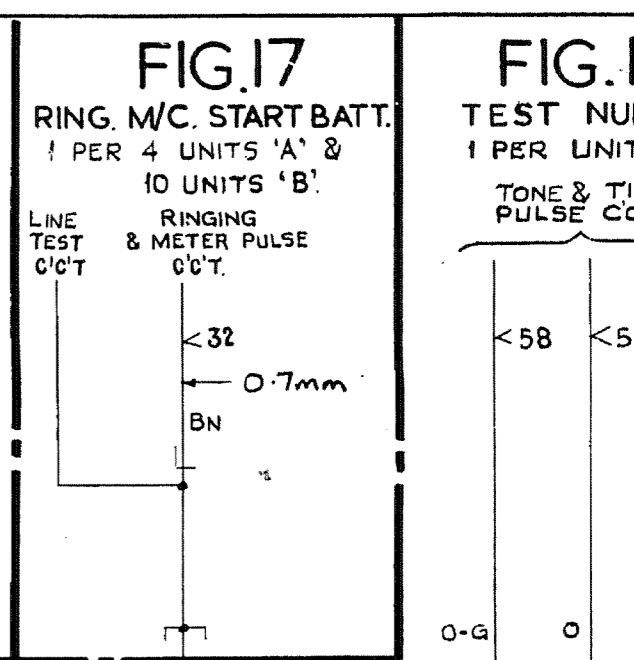
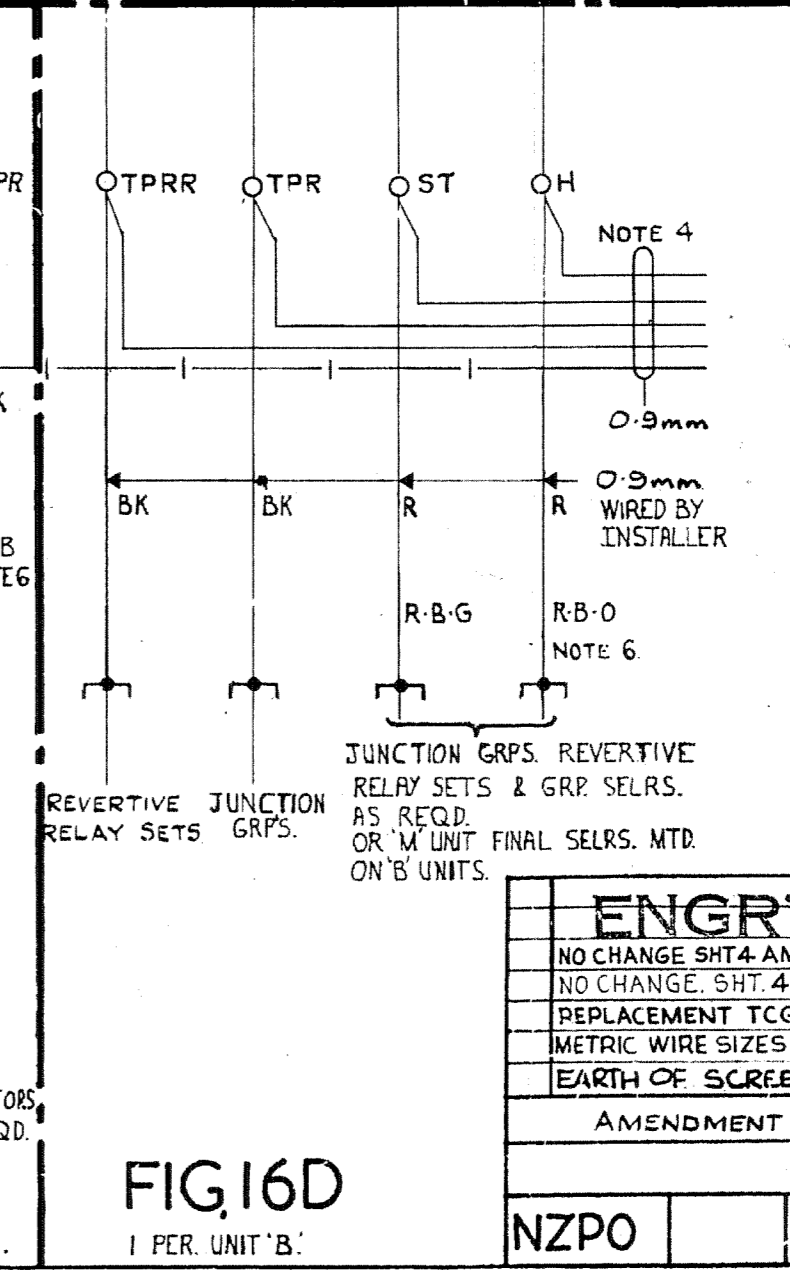
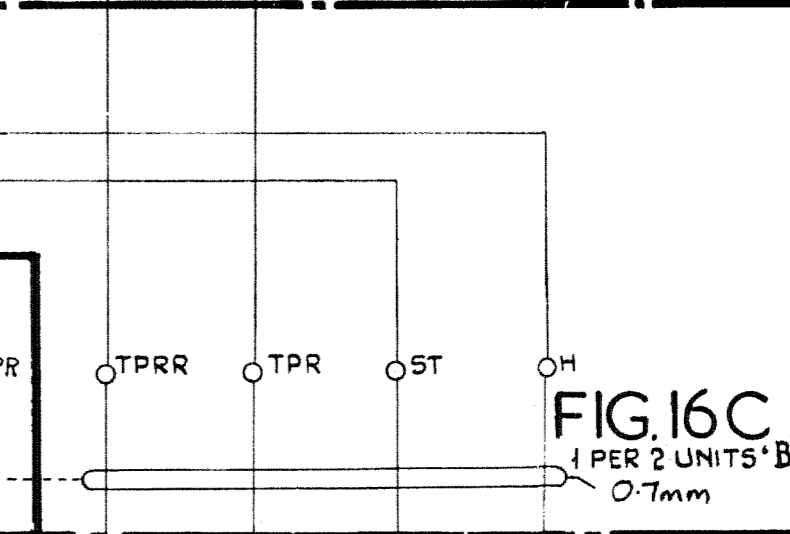
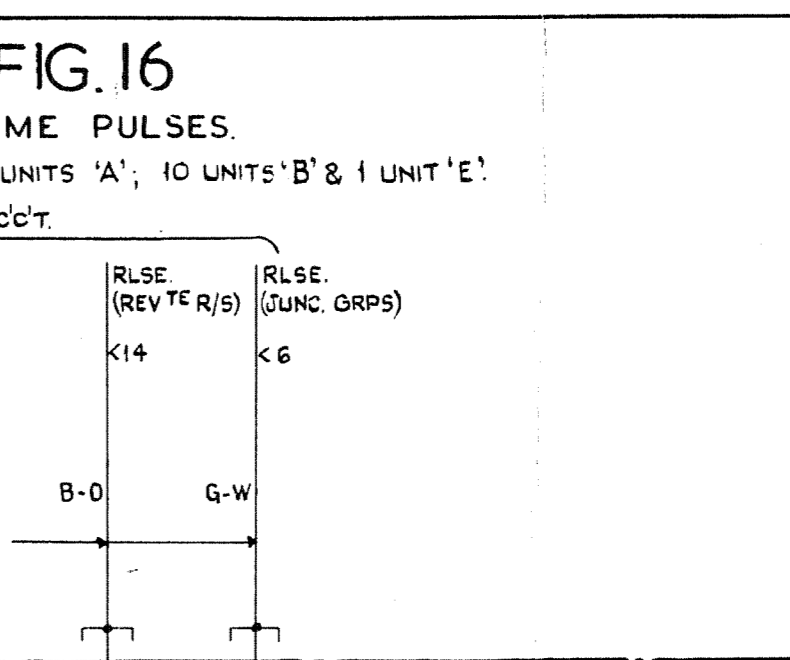
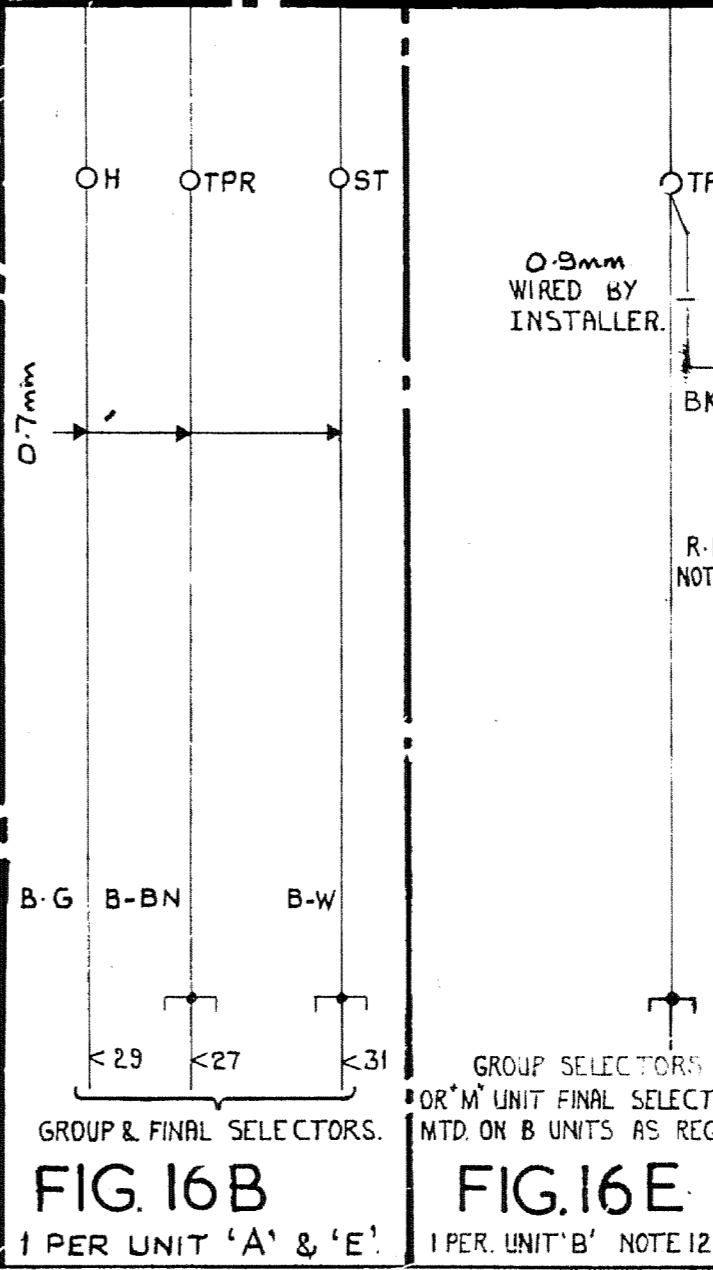
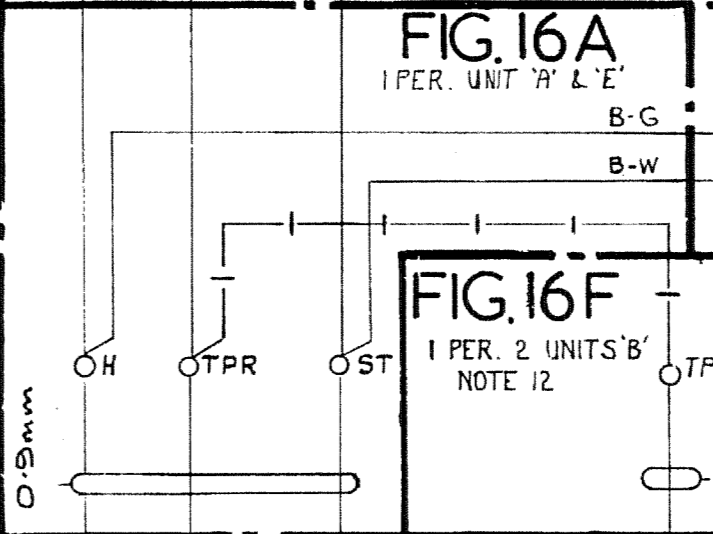
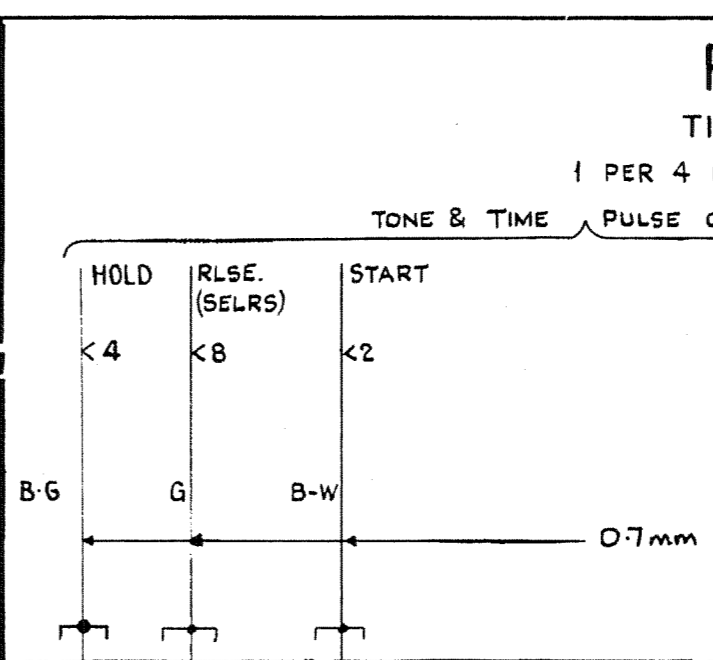
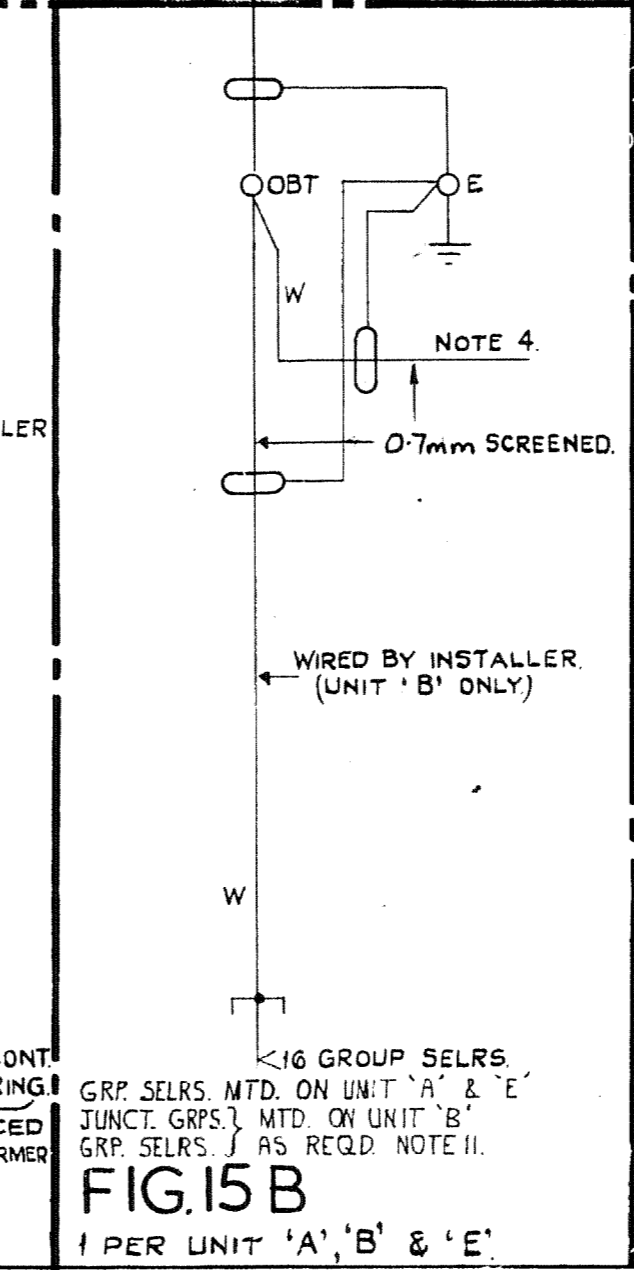
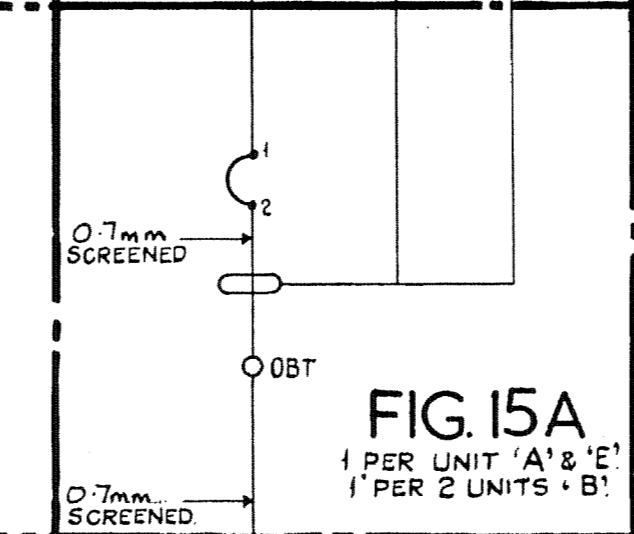
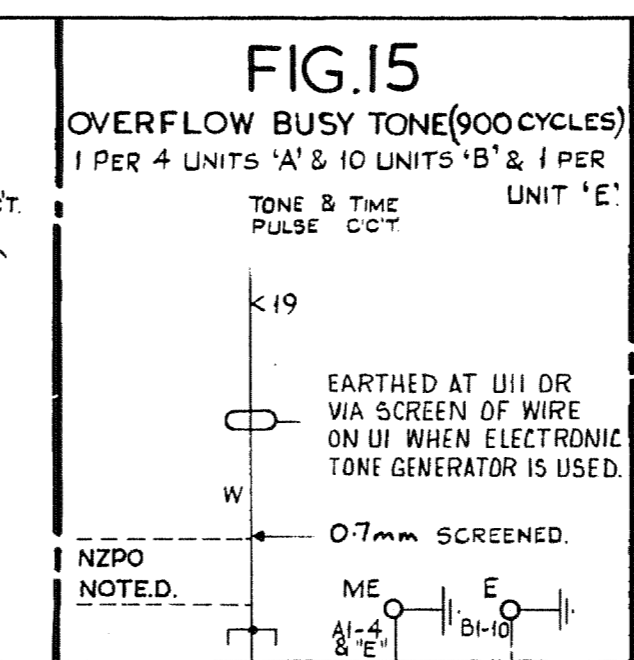
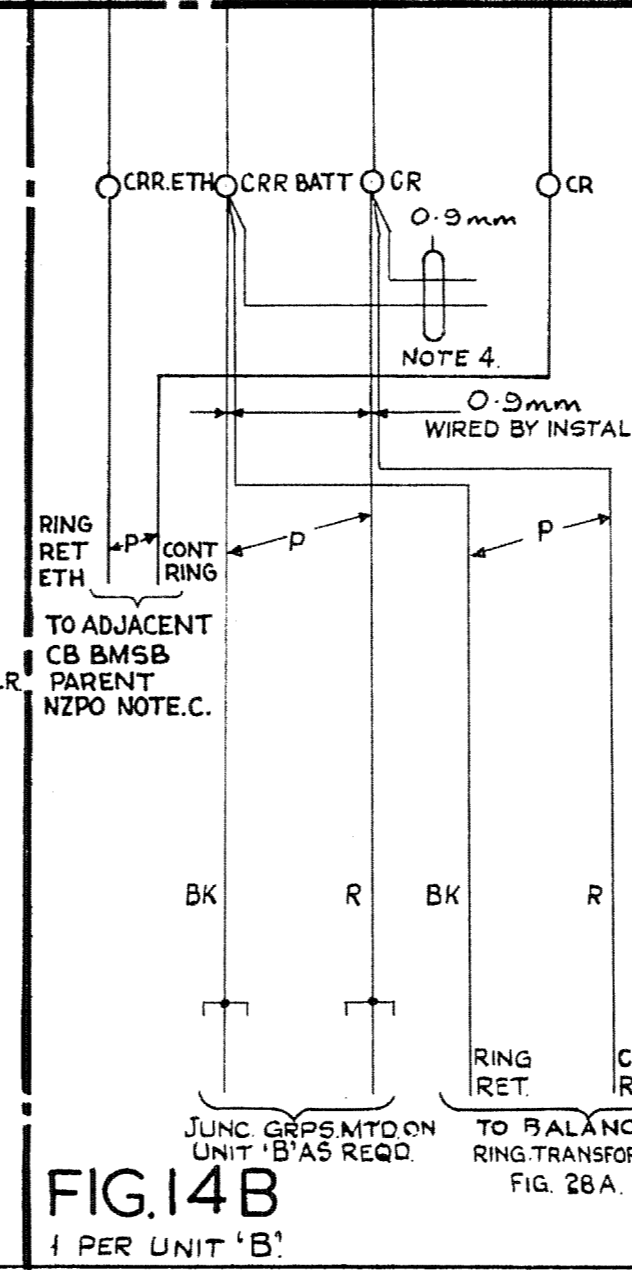
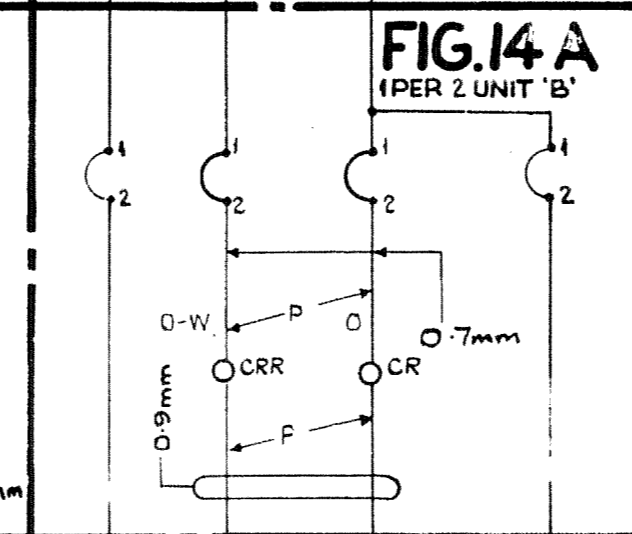
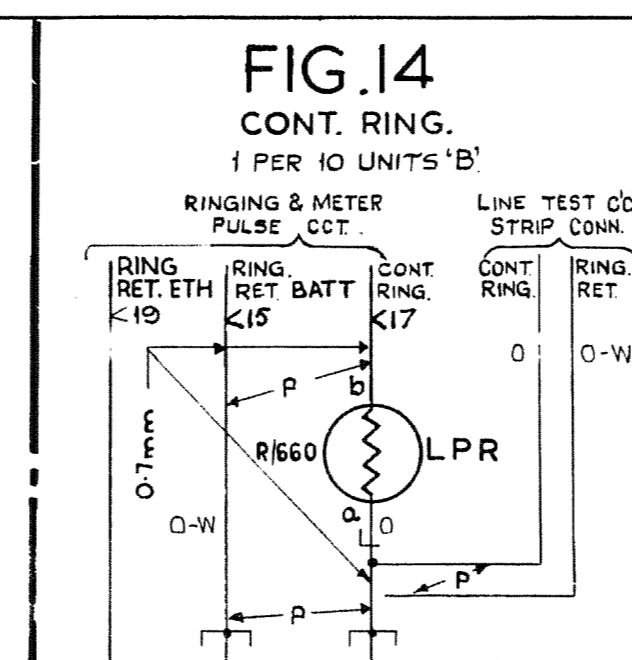
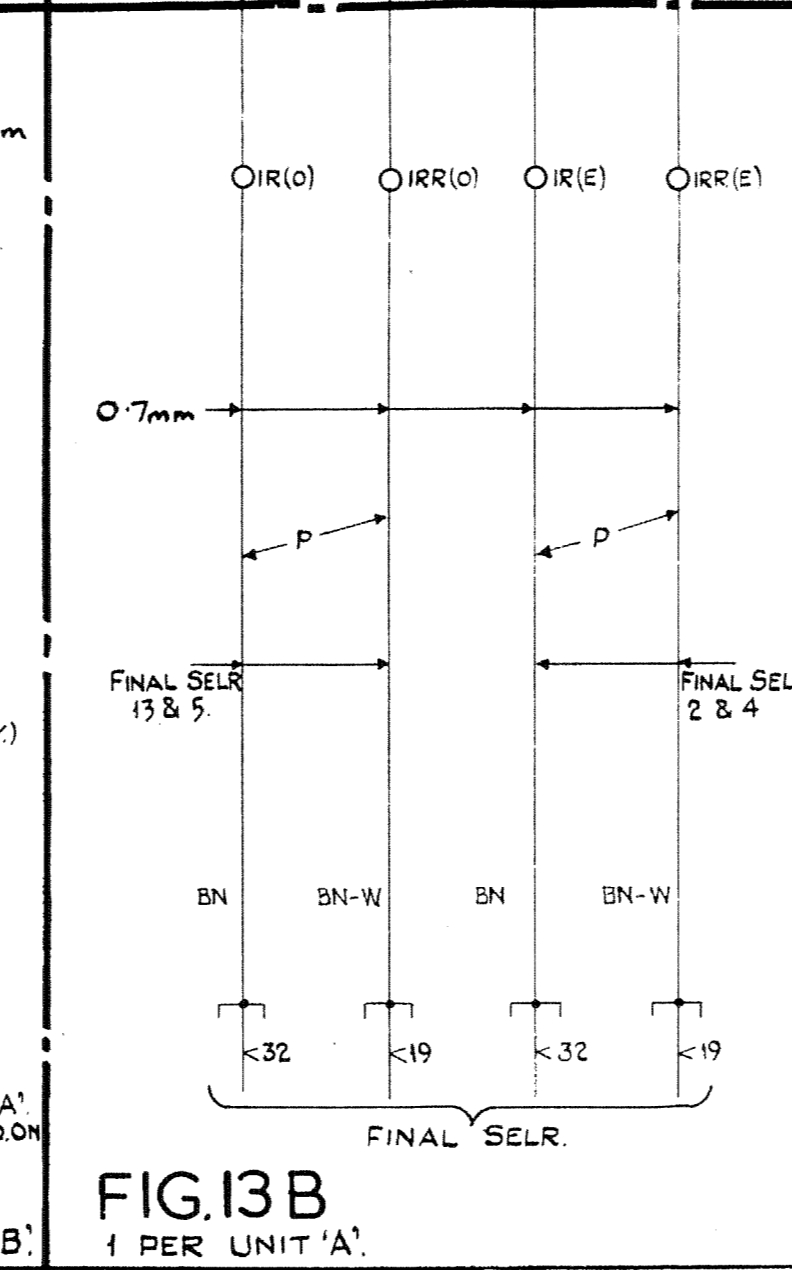
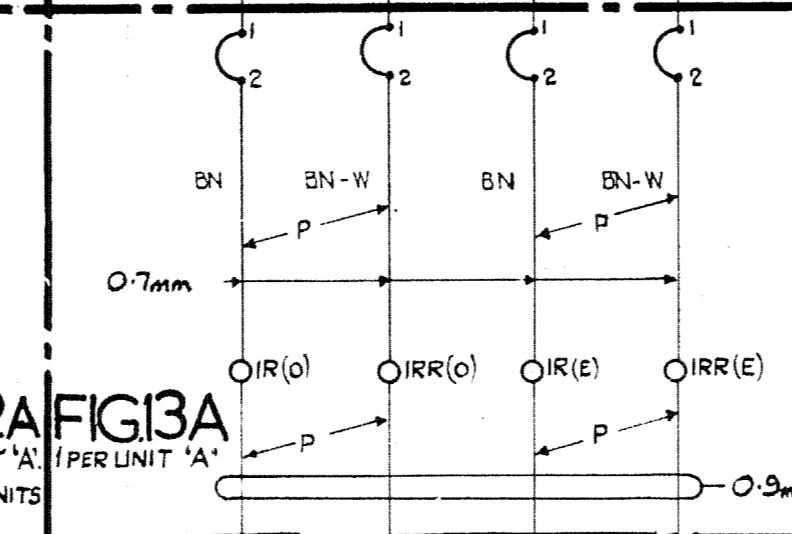
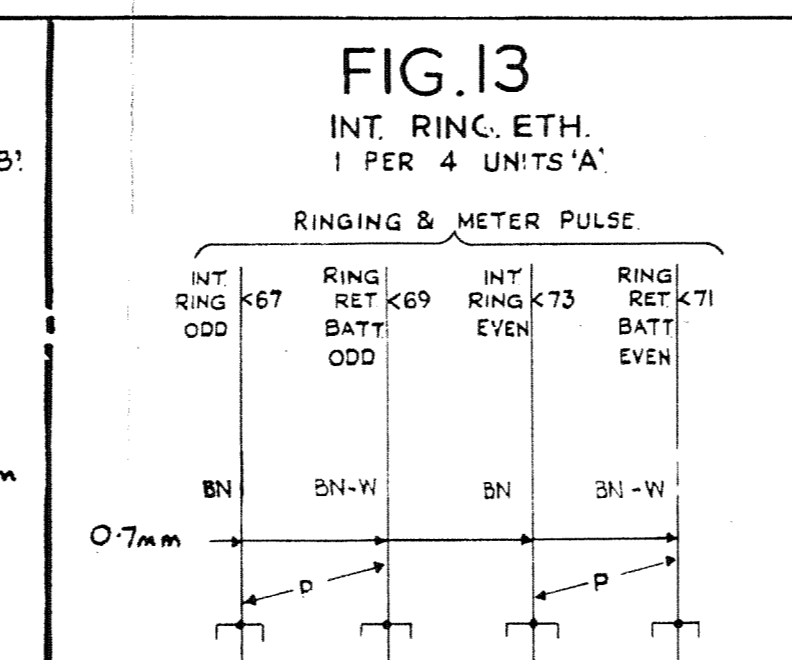
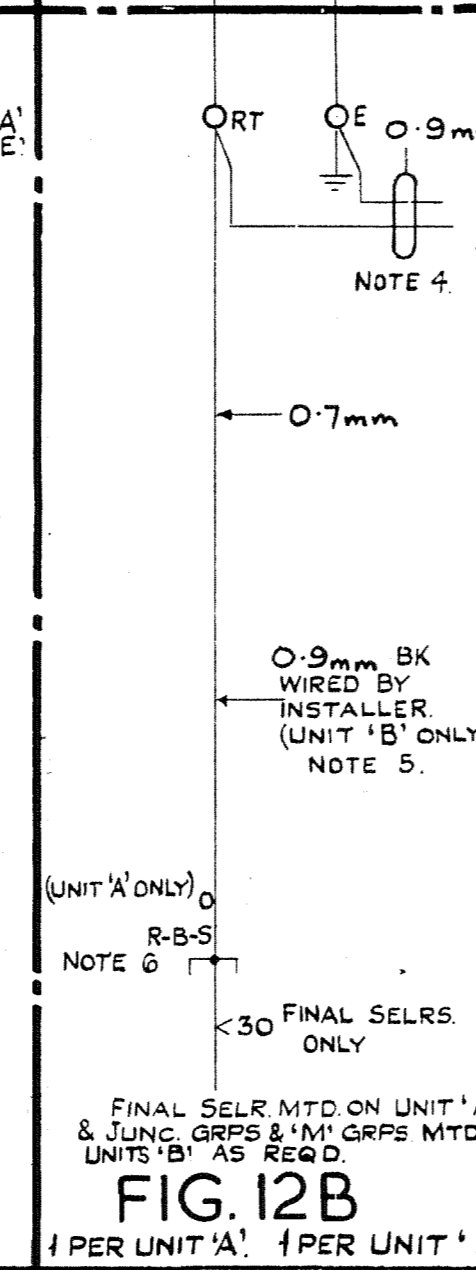
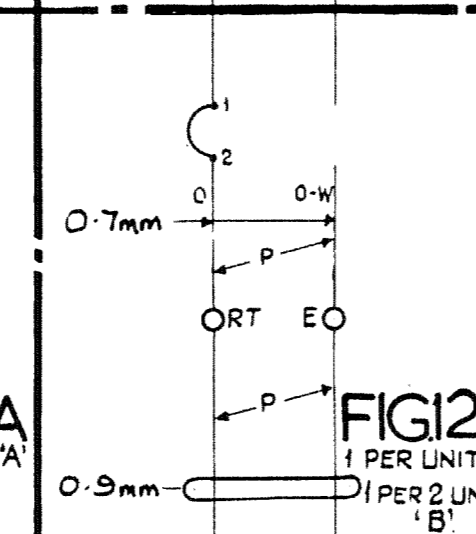
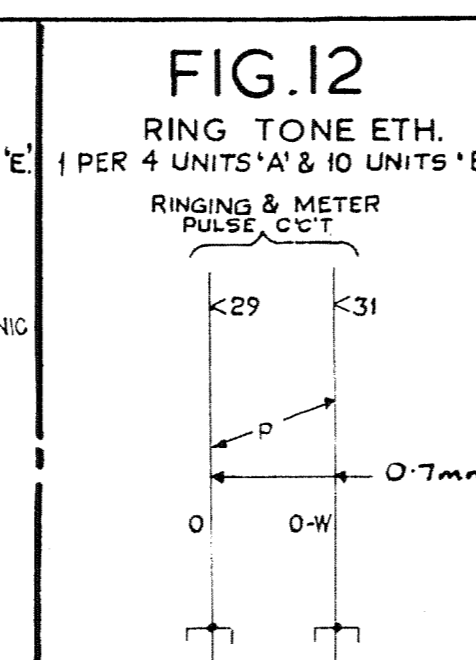
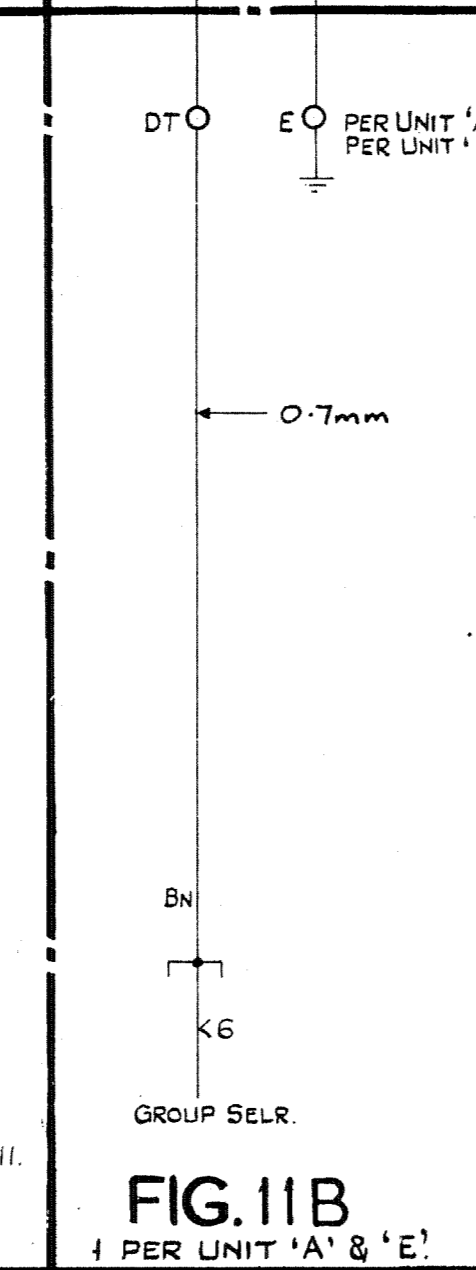
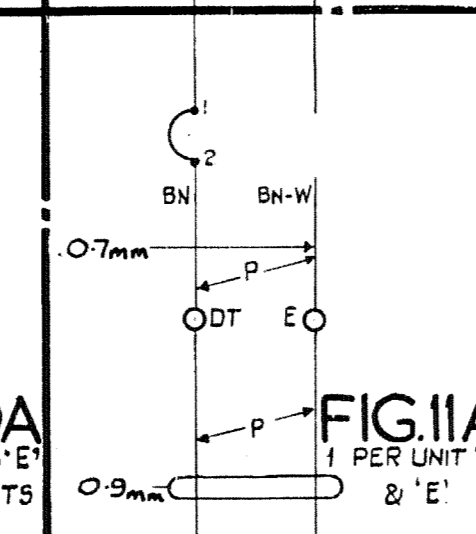
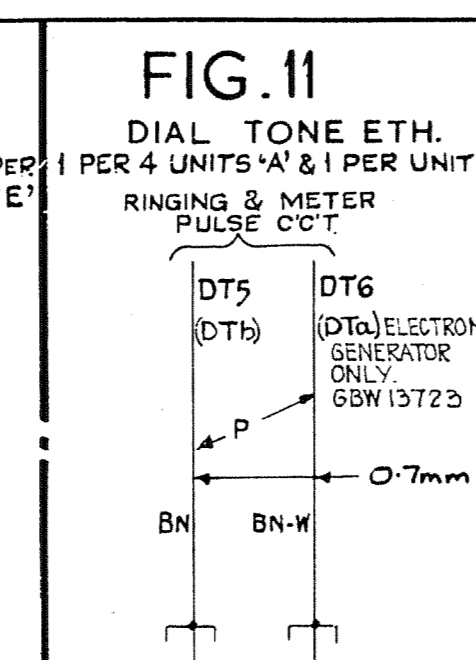
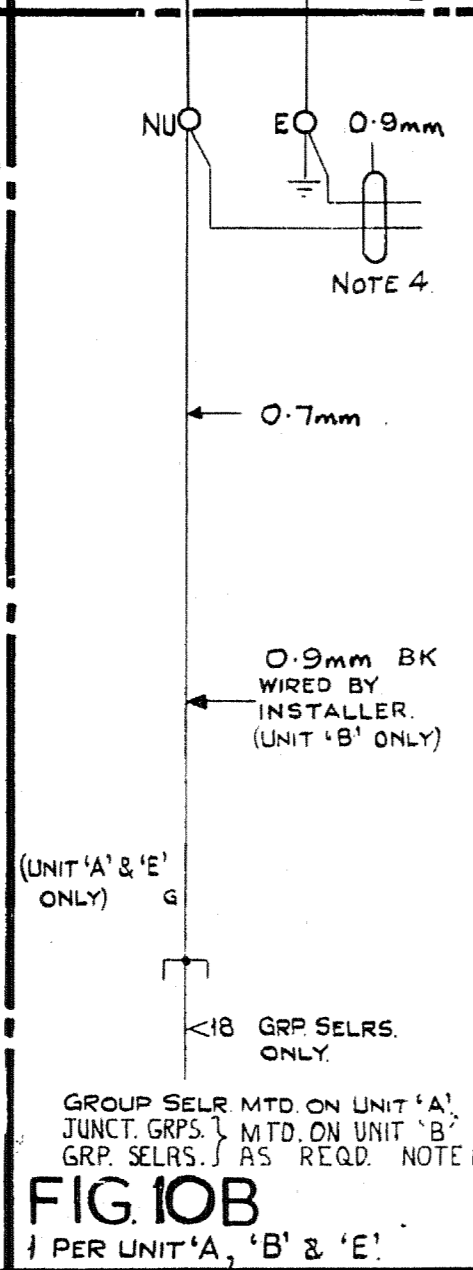
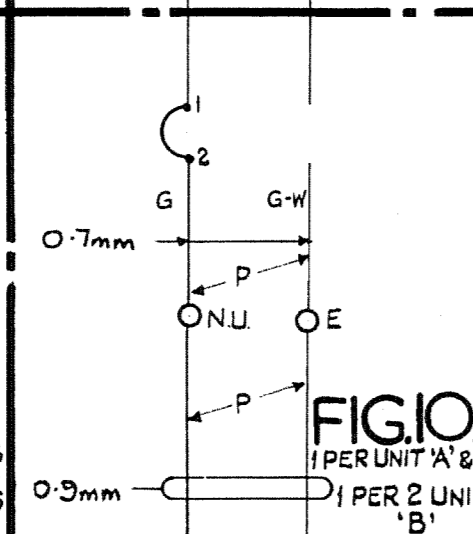
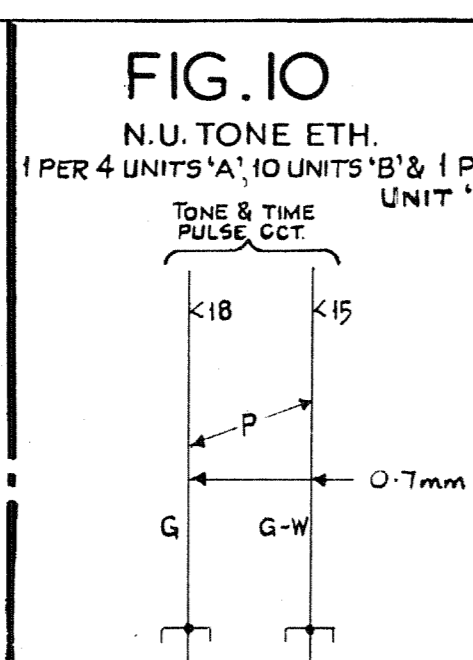
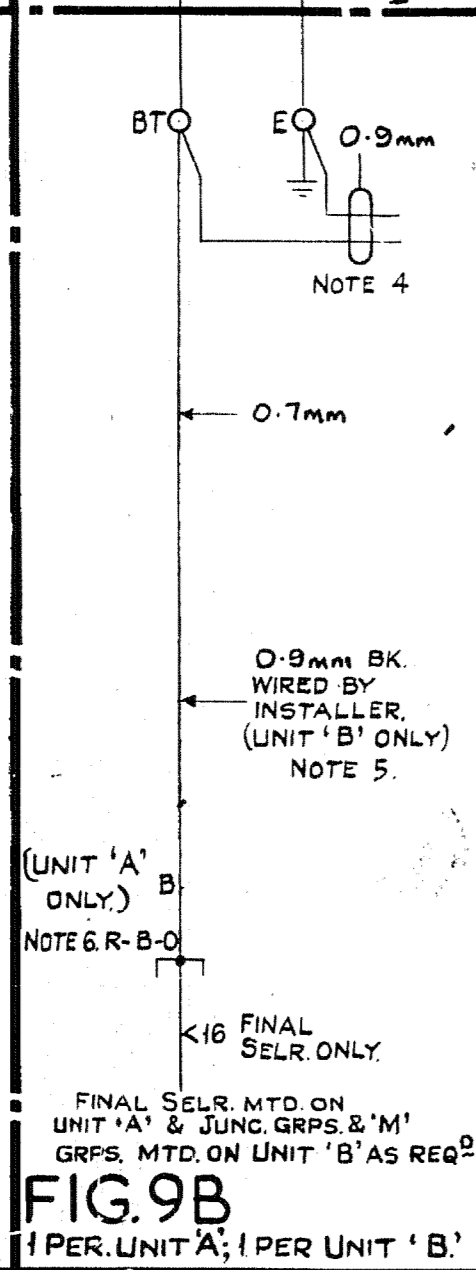
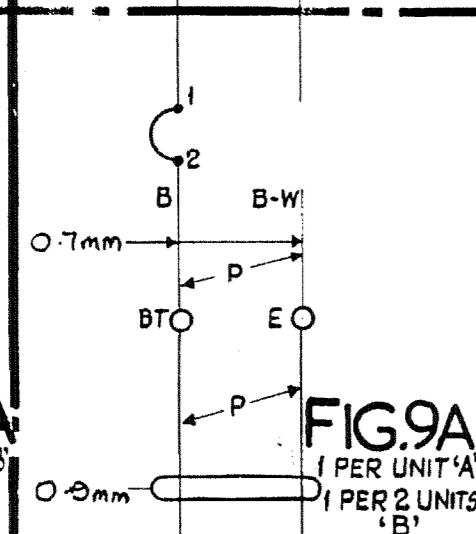
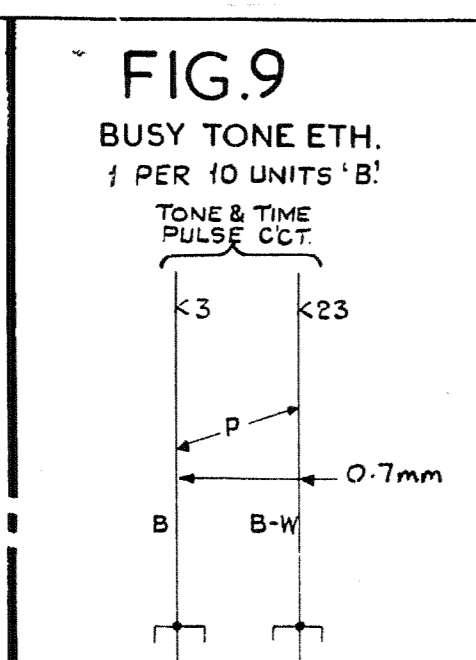
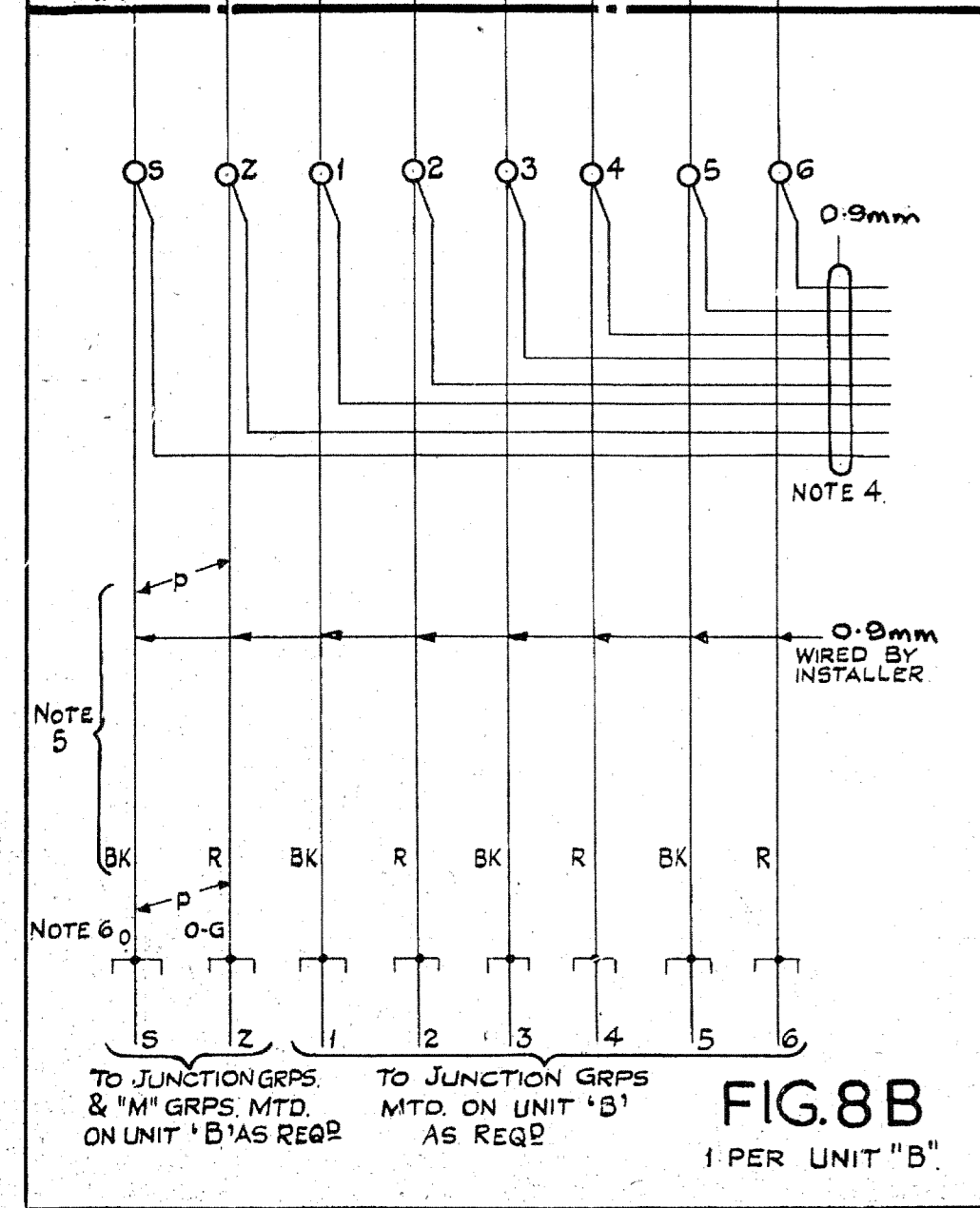
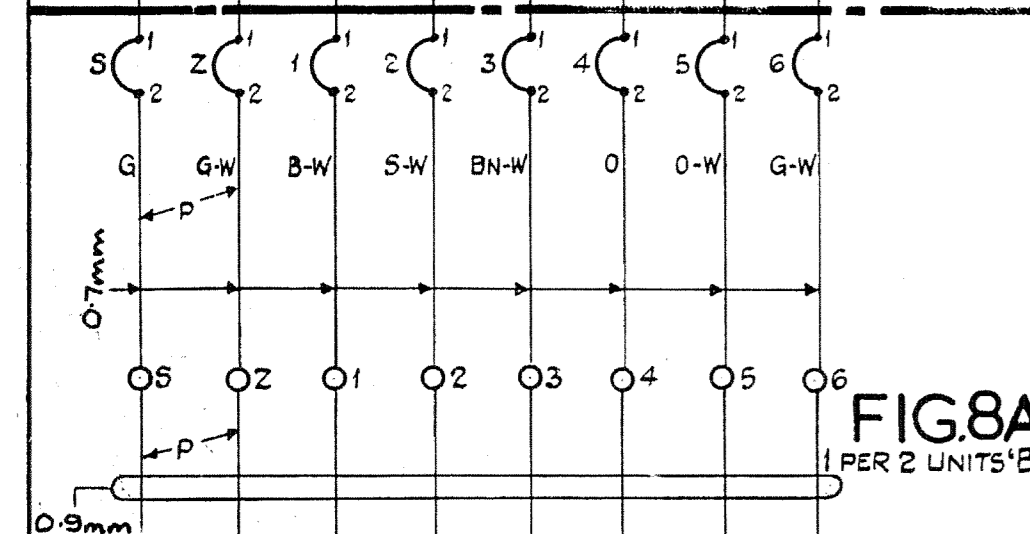
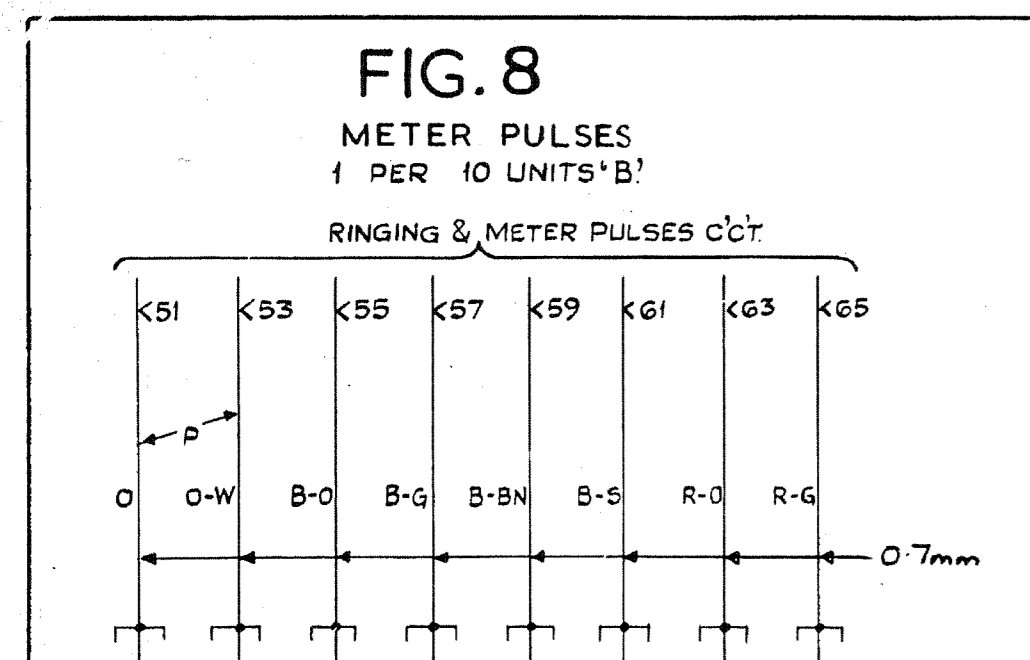

ENGR'S RECORD			RACK COMMON SERVICES	
NO CHANGE	SHT 4	AMD. SHT 5	RETRACED	DATE
				21A 24-3-82 LUF
				21 19-11-81 LUF
				20A 24-8-73 B.S.H
				20A 17-2-72 B.S.H
				19
AMENDMENT	PARTICULARS	ISSUE DATE	APP'D	
NZPO				

GBW 13730

SHEET 2/5

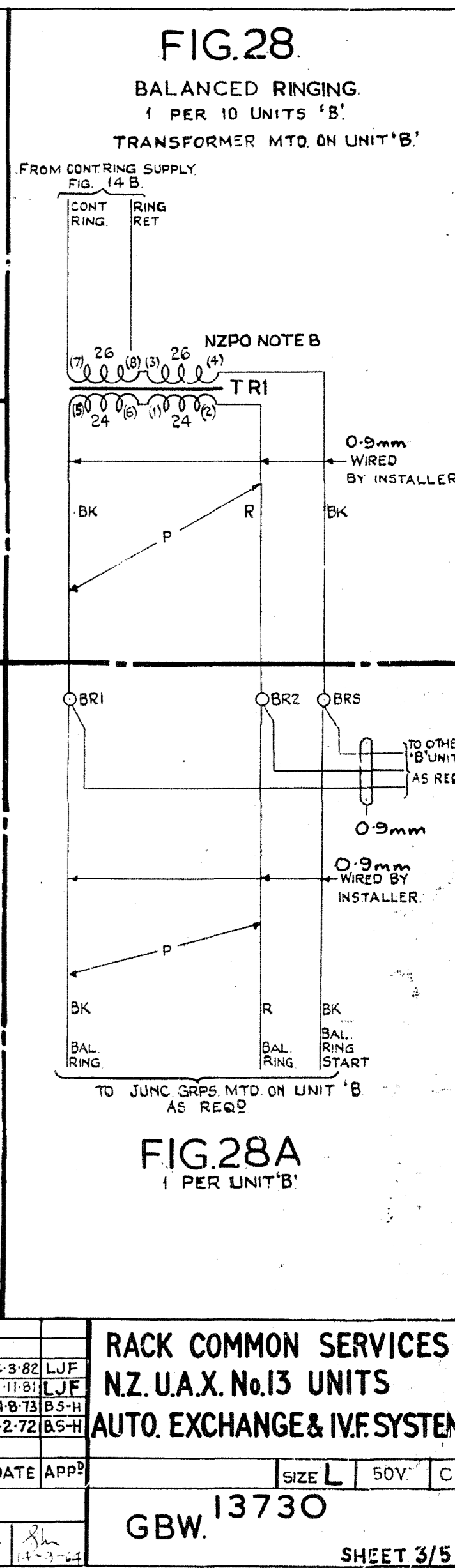
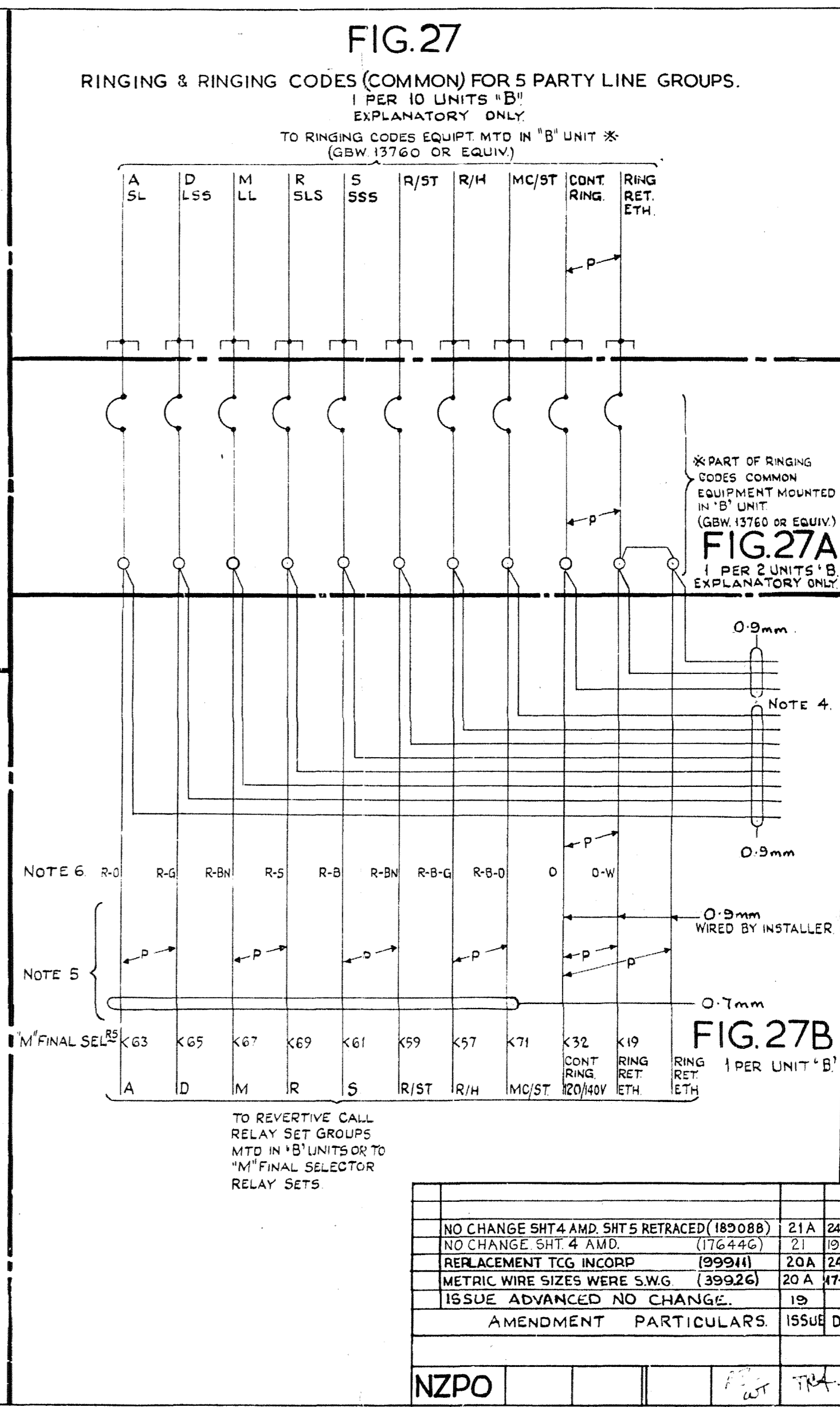
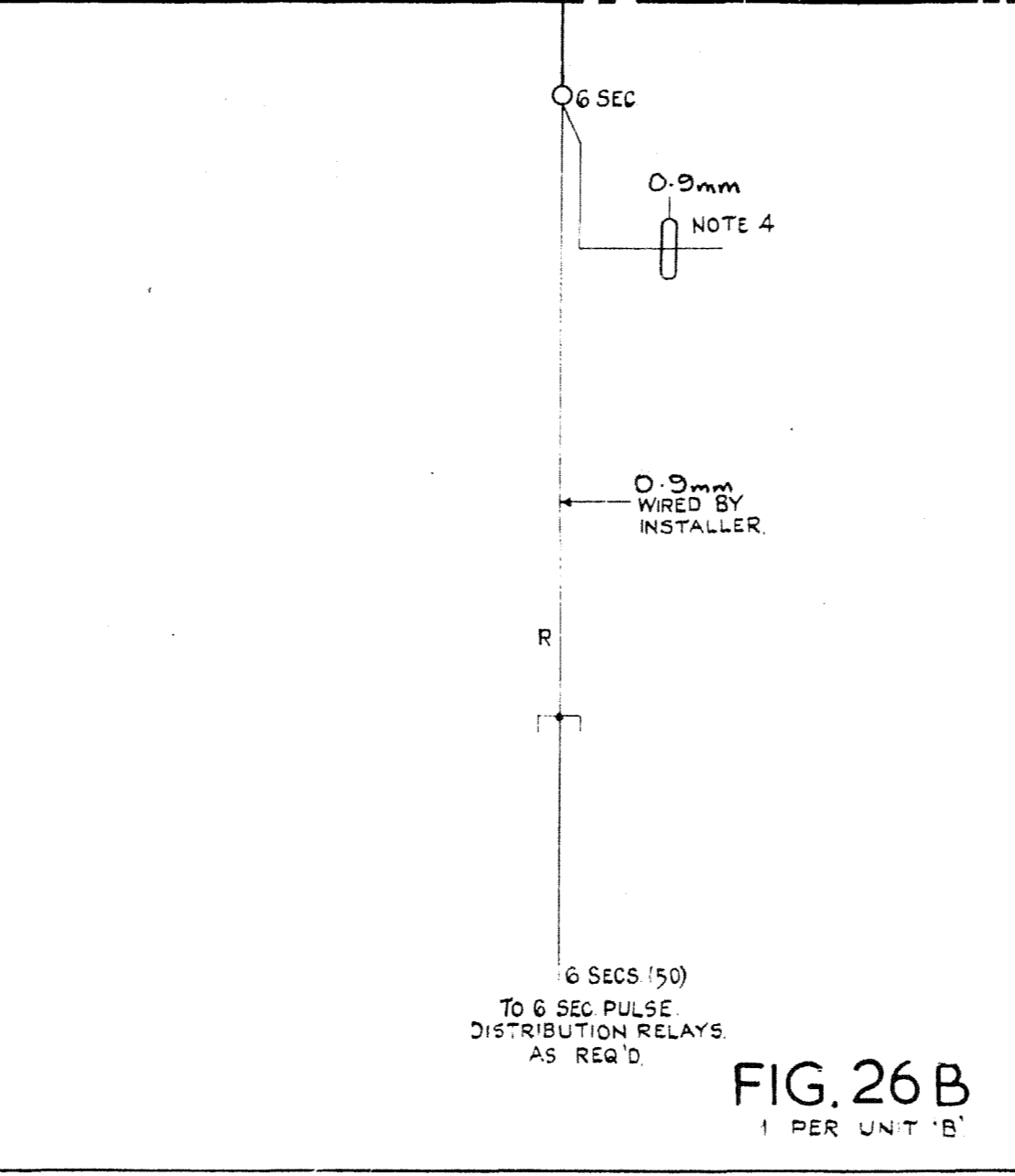
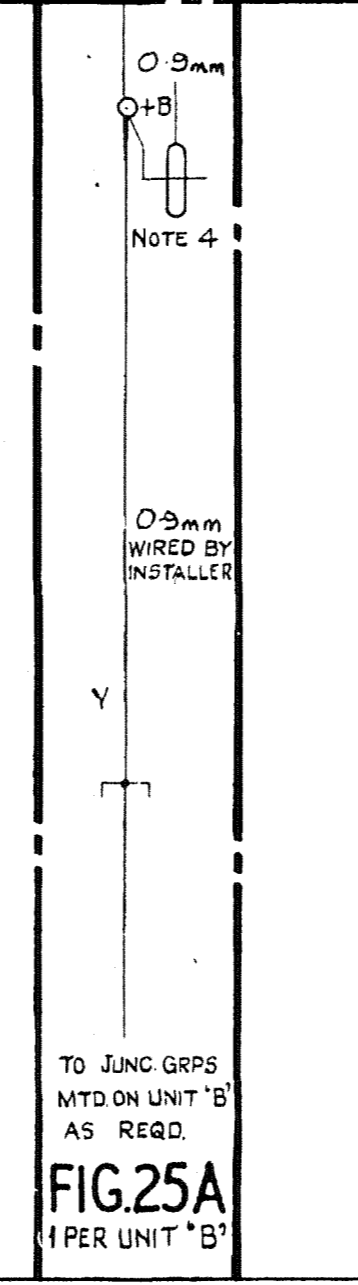
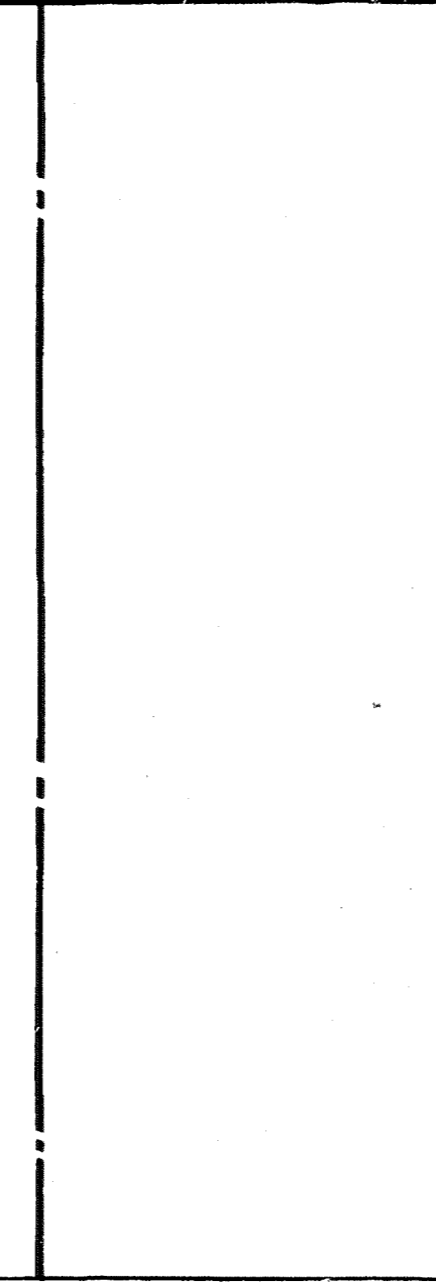
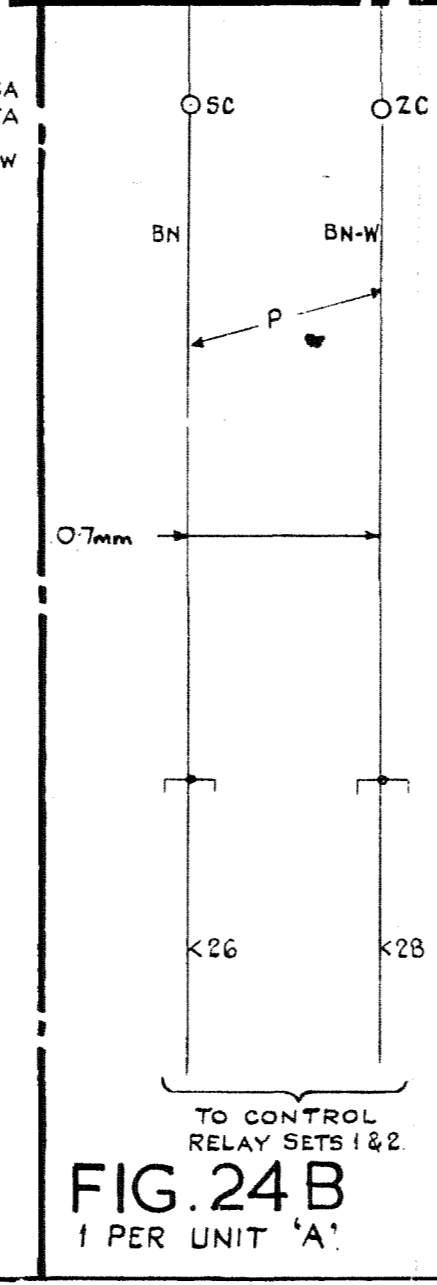
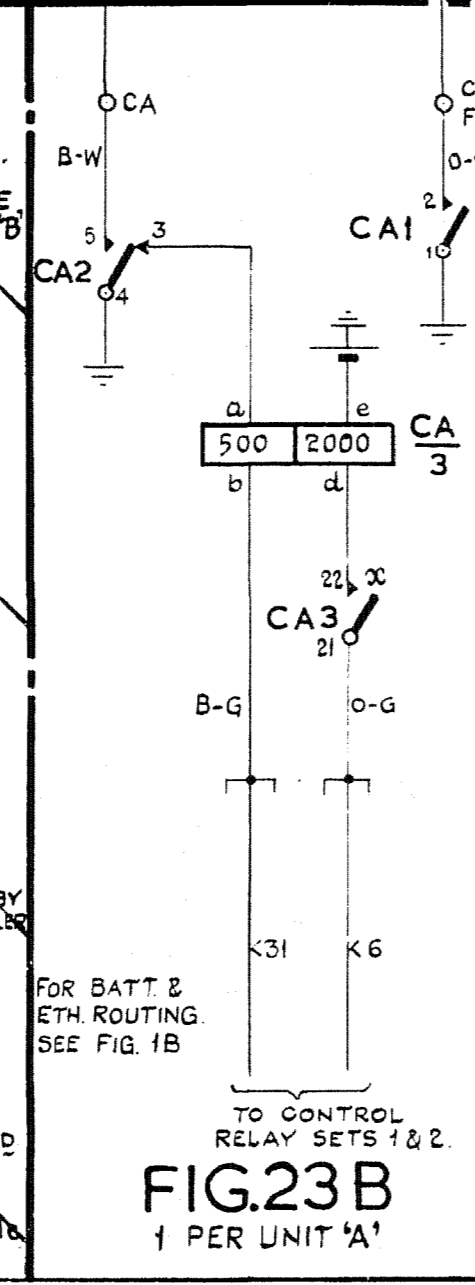
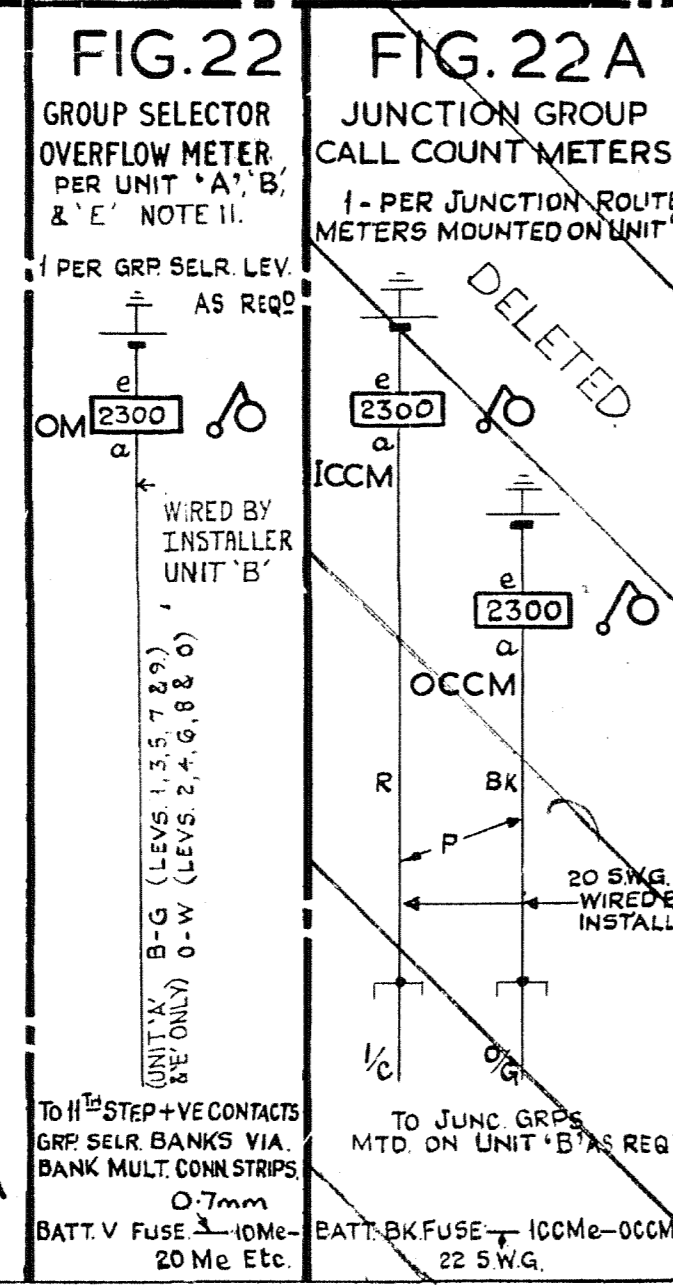
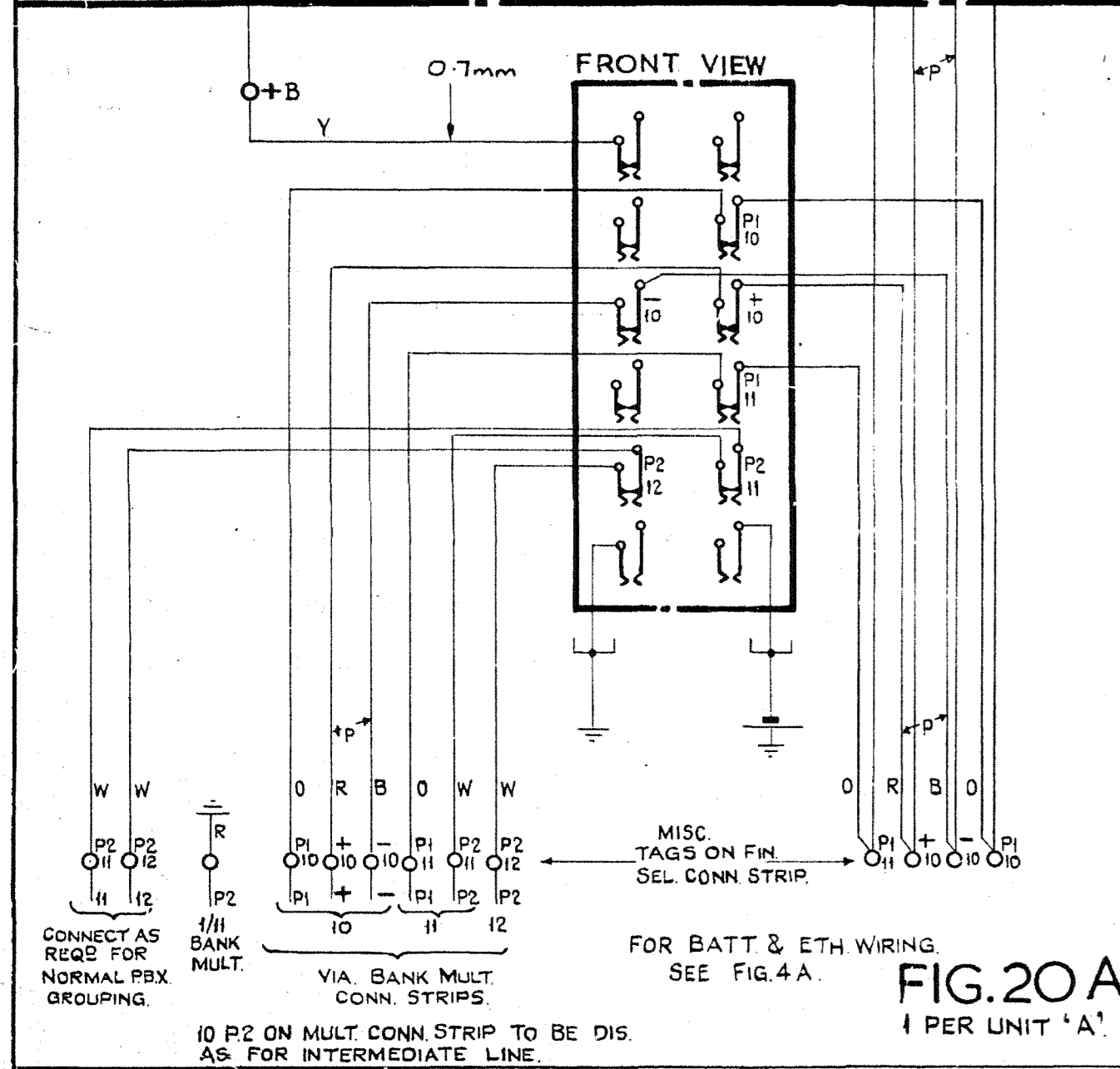
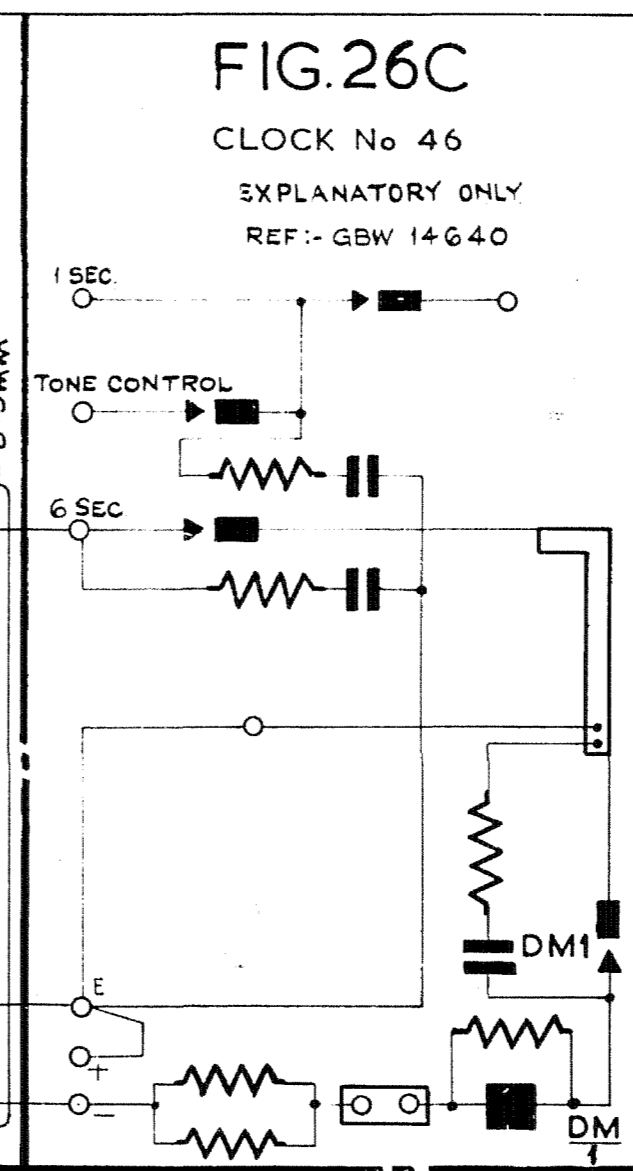
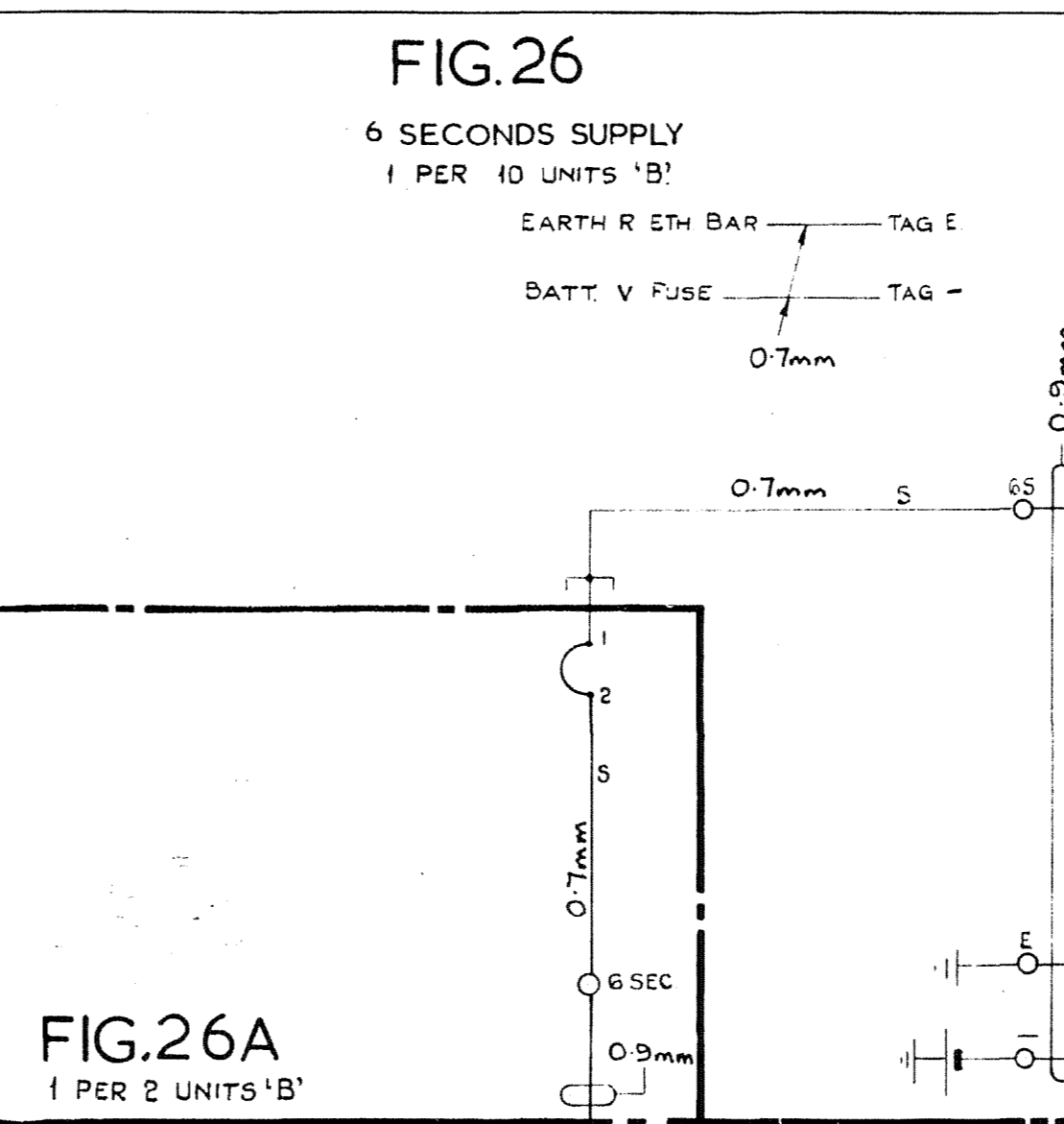
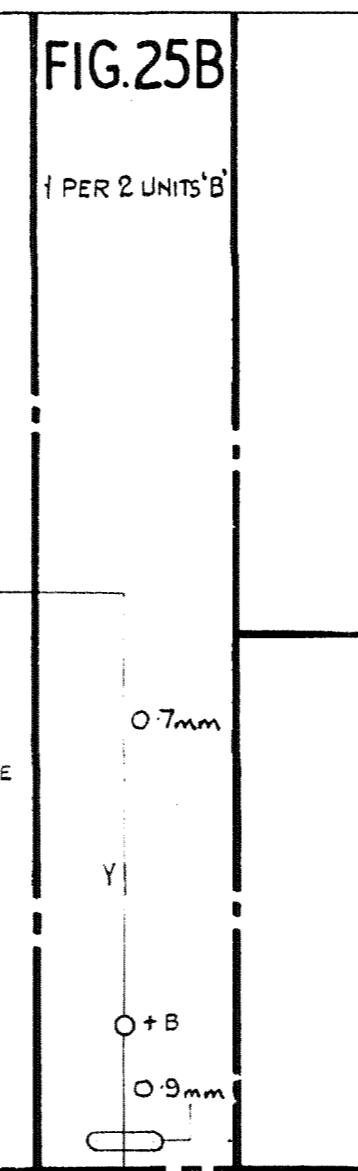
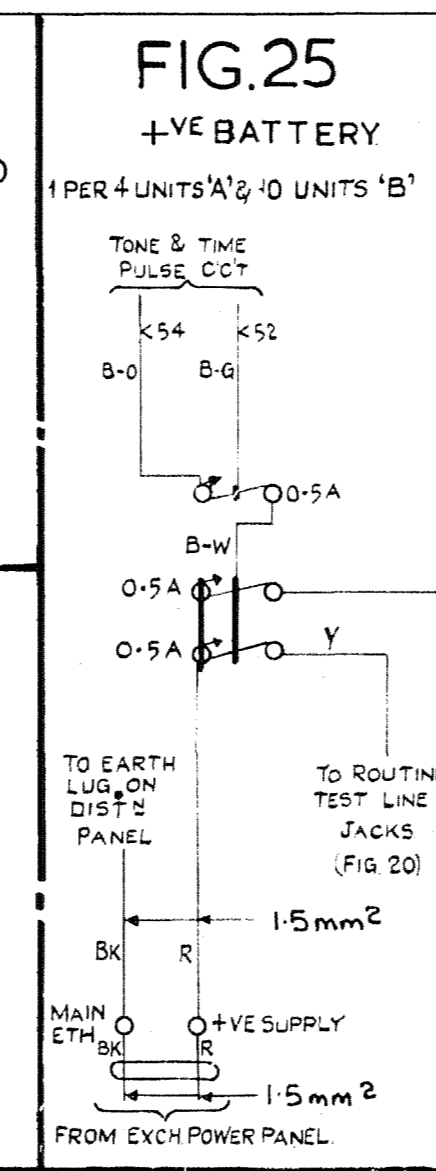
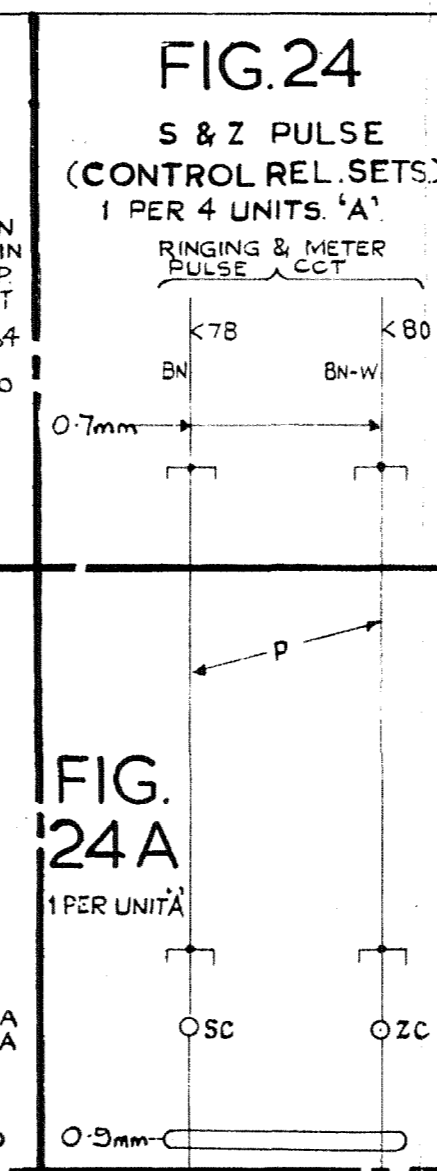
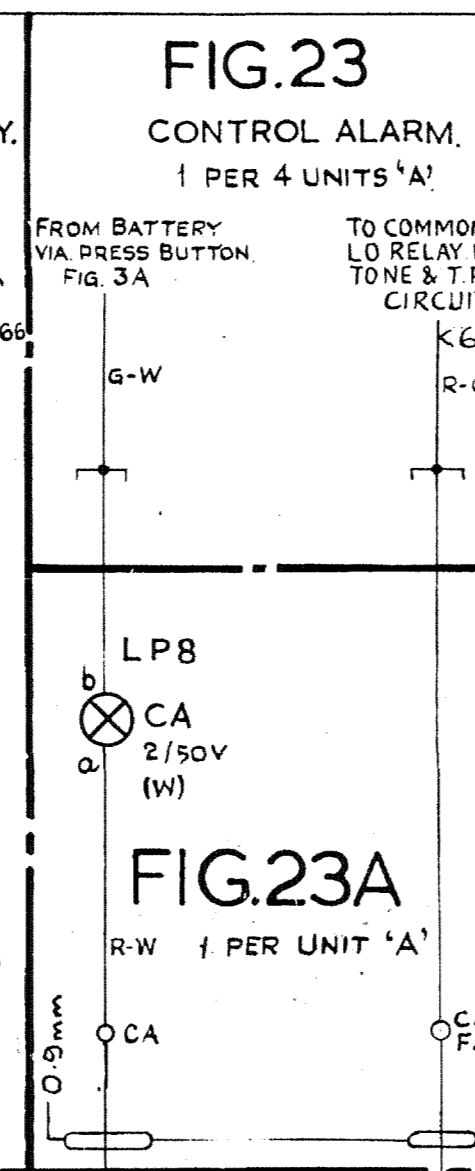
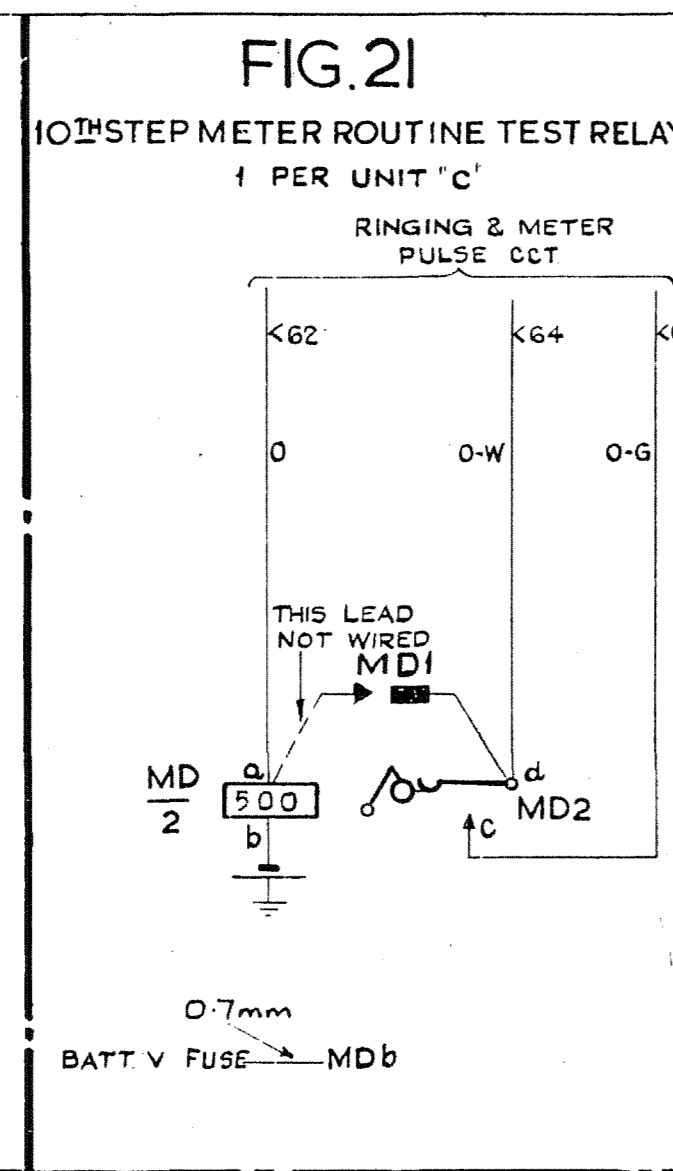
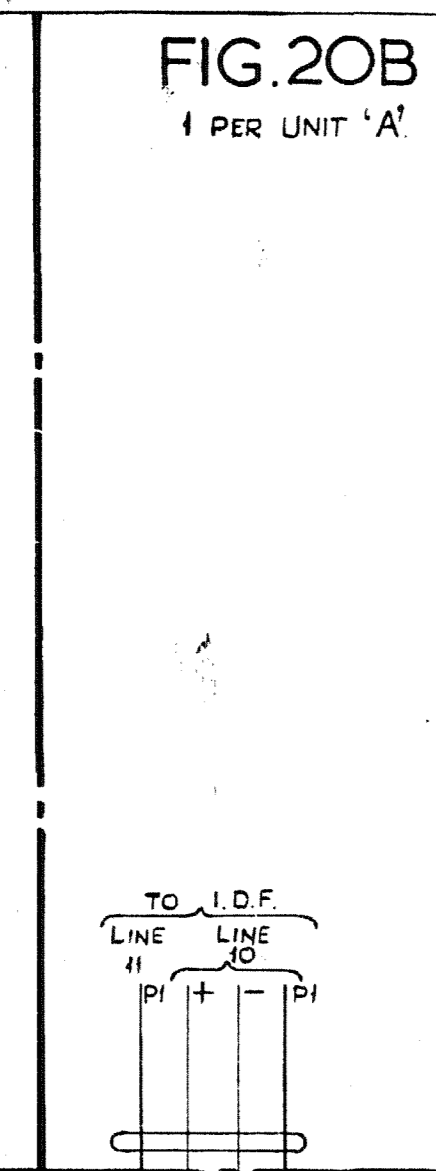
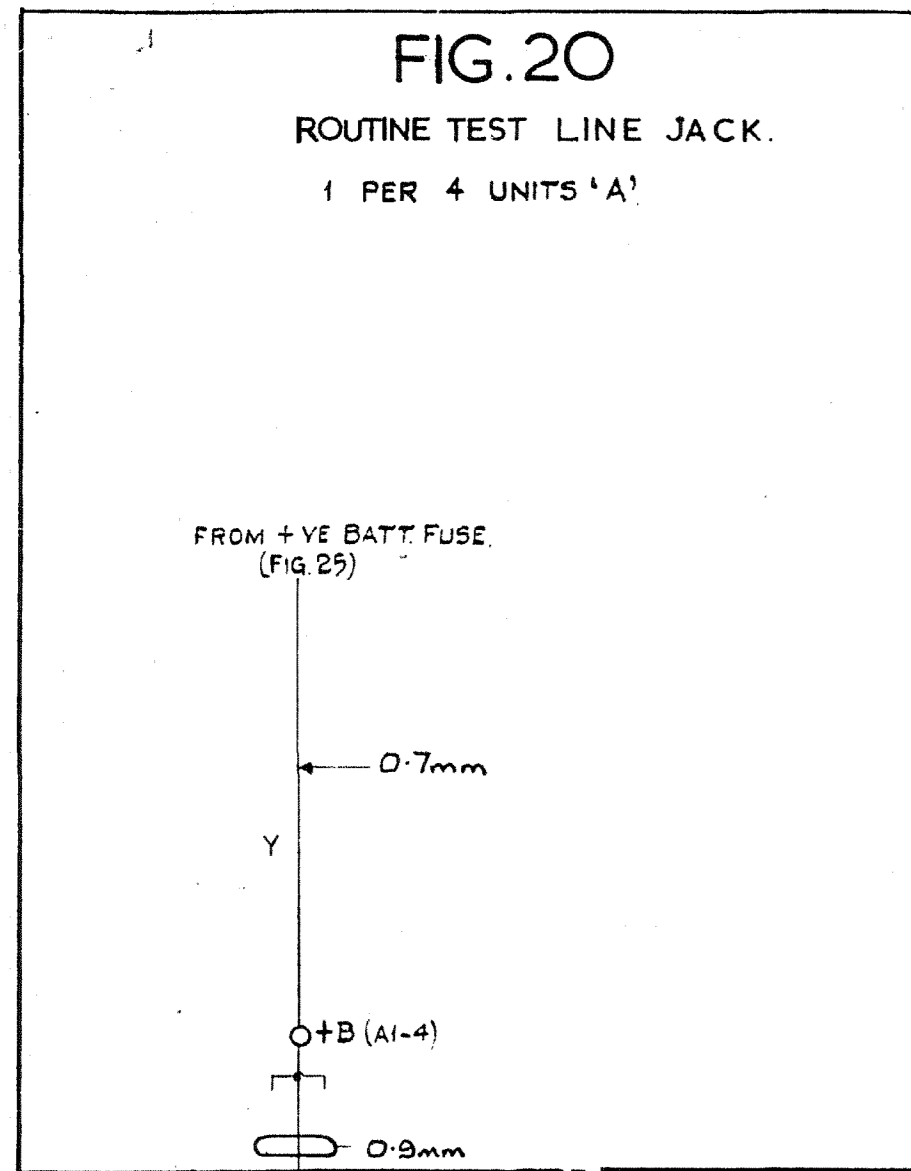

RACK COMMON SERVICES			
N.Z. U.A.X. No.13 UNITS			
AUTO. EXCHANGE & IVF. SYSTEM			
NO CHANGE SHT 4 AMD. SHT 5 RETRACED (189088)	21A	24-3-82	LJF
NO CHANGE SHT 4 AMD. (176446)	21	19-11-81	LJF
REPLACEMENT TCG INCORP (39911)	20A	24-8-73	BS-H
METRIC WIRE SIZES WERE S.W.G (39926)	20A	17-2-72	BS-H
ISSUE ADVANCED NO CHANGE.	19		
AMENDMENT PARTICULARS.	ISSUE DATE	APP'D	SIZE L 50V C
NZPO			
			GBW. 13730
			SHEET 3/5

FIG.29 REVERTIVE PULSE
1 PER 10 UNITS 'B'

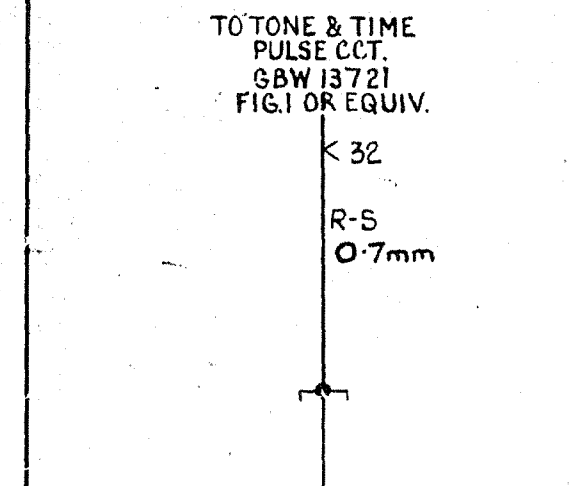

FIG.29A
1 PER 2 UNITS 'B'

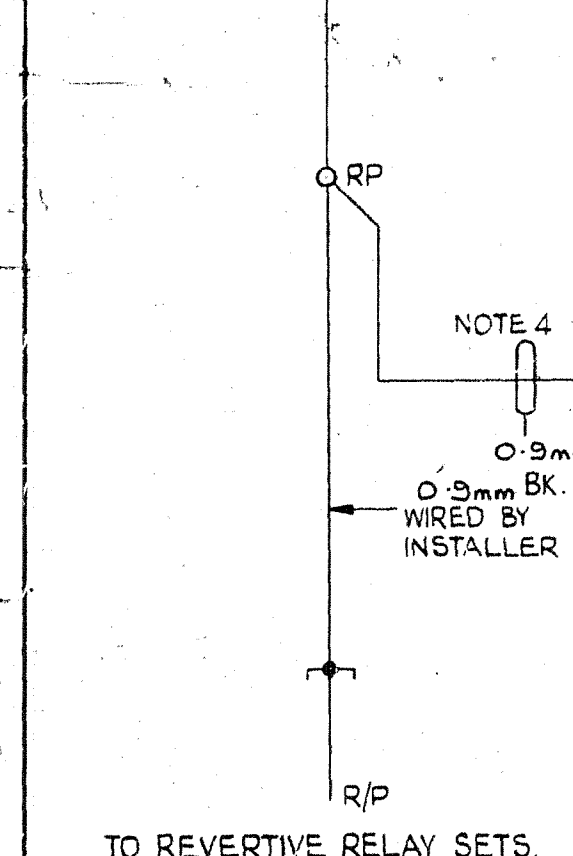
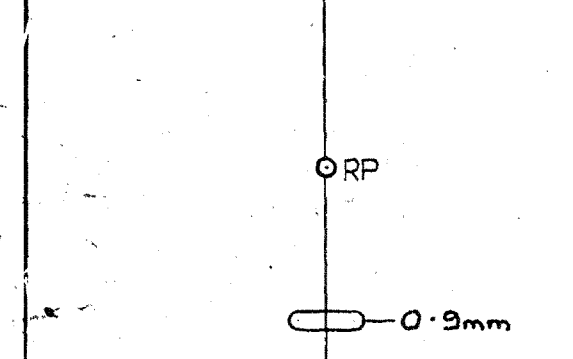

FIG.29B 1 PER UNIT 'B'

FIG.30 FUSE ALARM POSITIVE BATTERY SUPPLY
1 PER GRP. OF UNITS 'S'

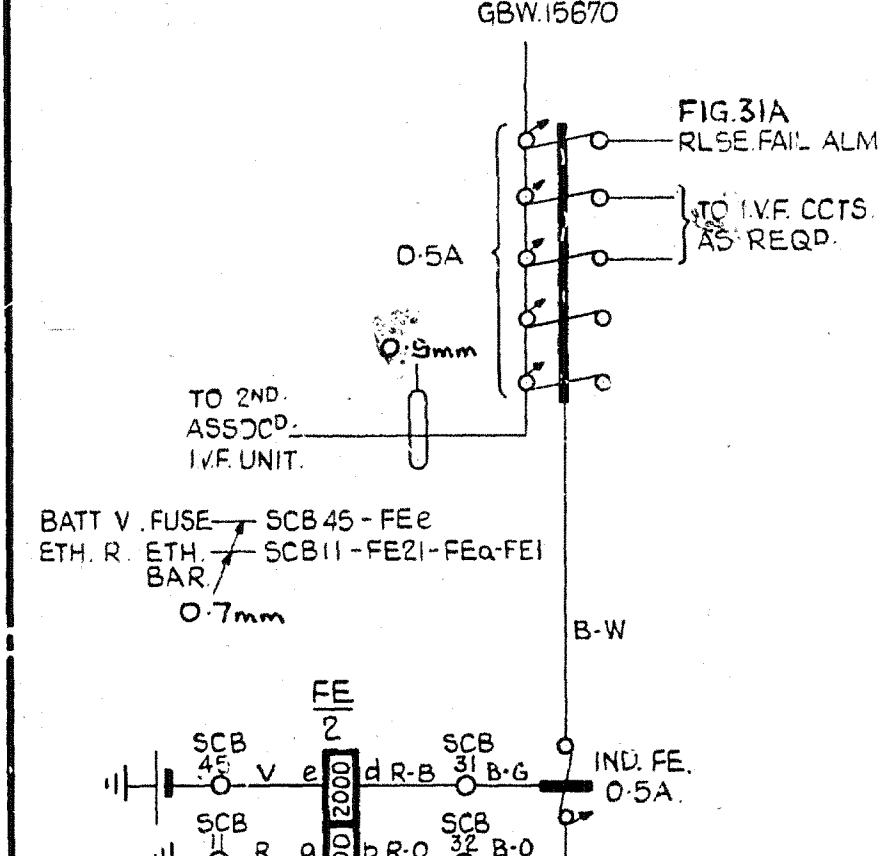
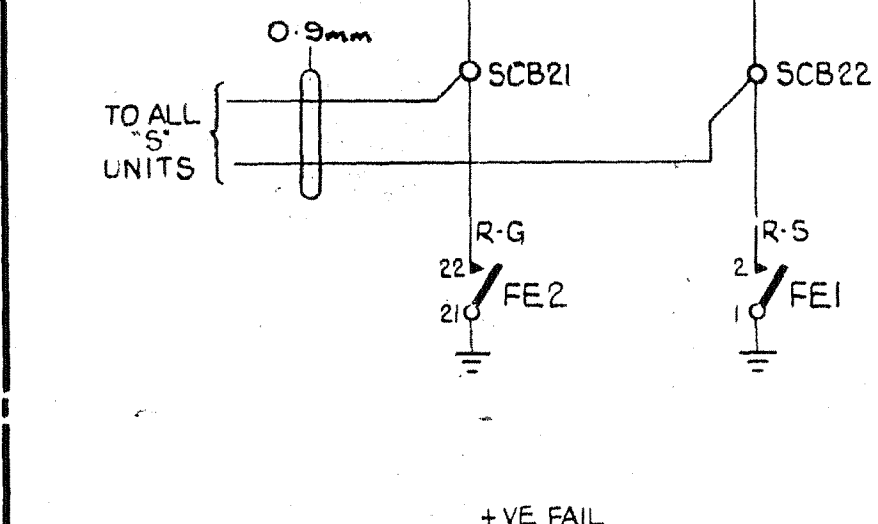
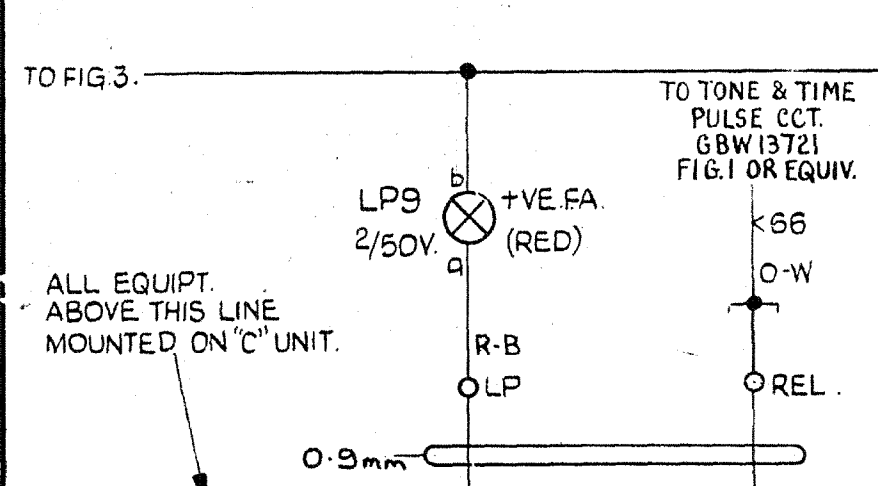

FIG.30A 1 PER UNIT 'S'

FIG.31 RELEASE FAILURE ALARM (10 SECS. APPROX.)
1 PER GRP. OF UNITS 'S'

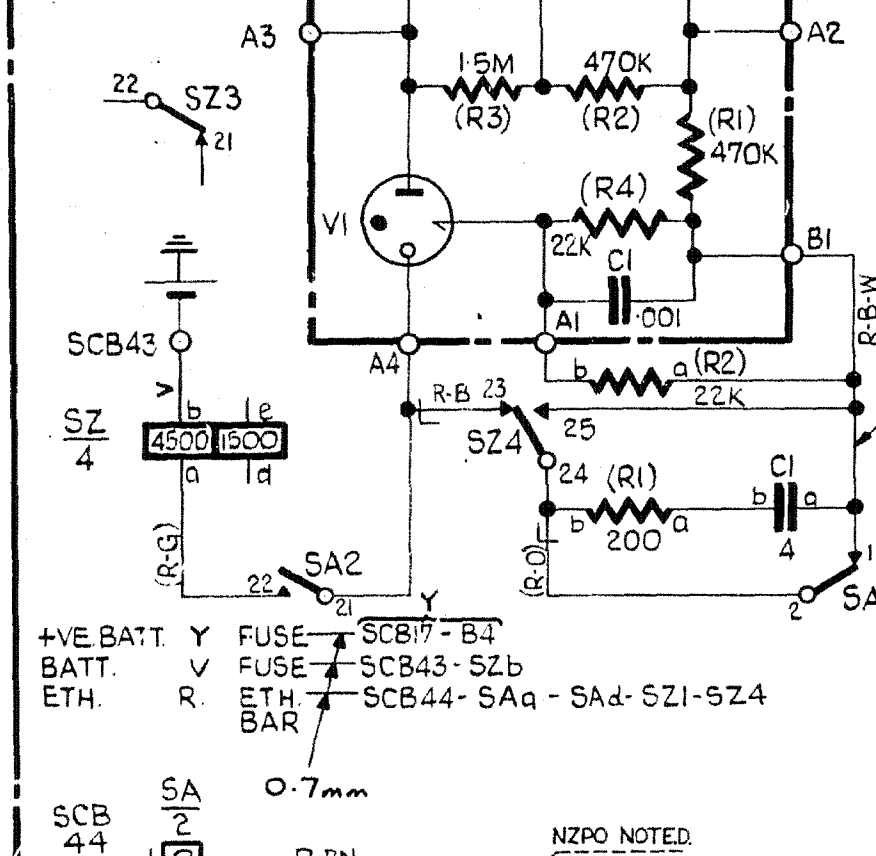
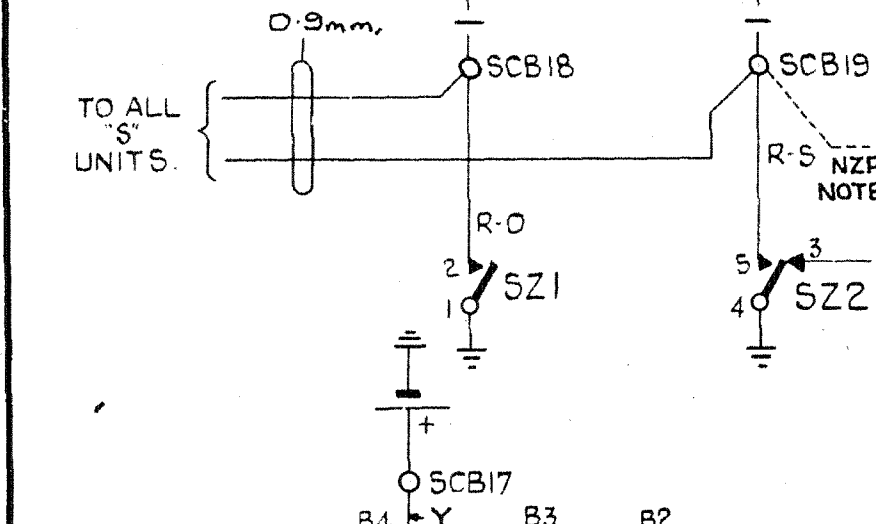
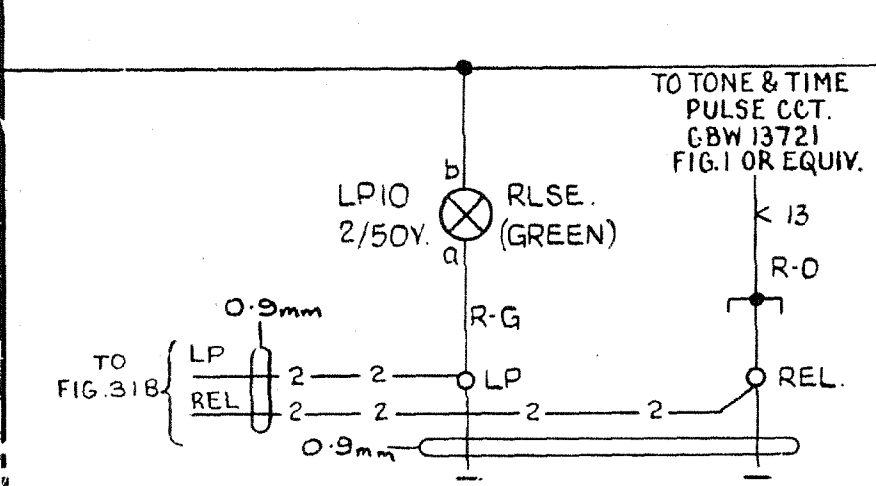

FIG.31A 1 PER UNIT 'S'

FIG.32 FUSE ALARM HEATER SUPPLY (I.V.F.)
1 PER GRP. OF UNITS 'S'

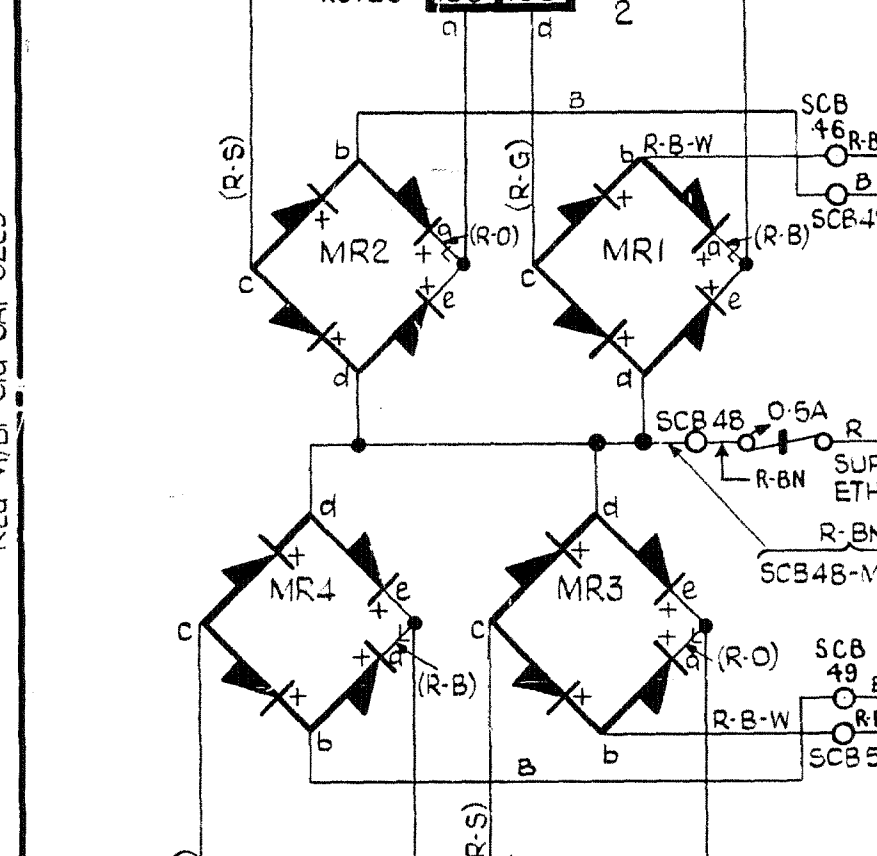
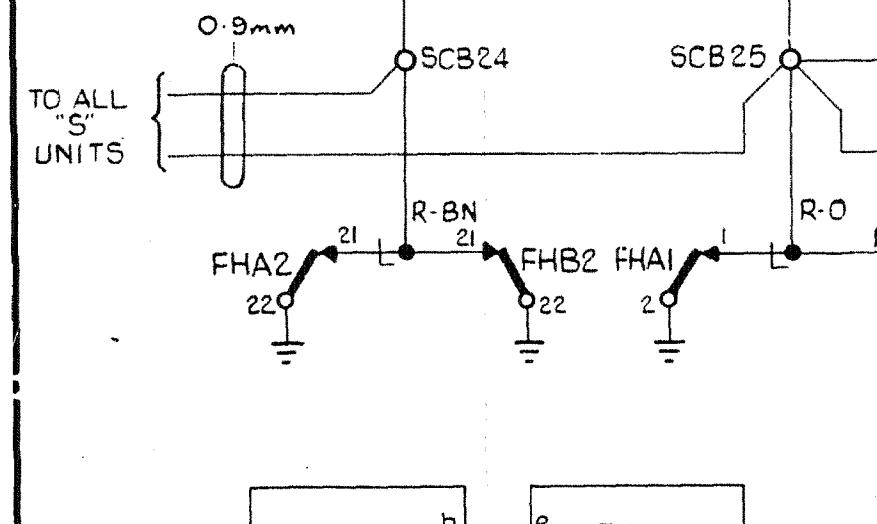
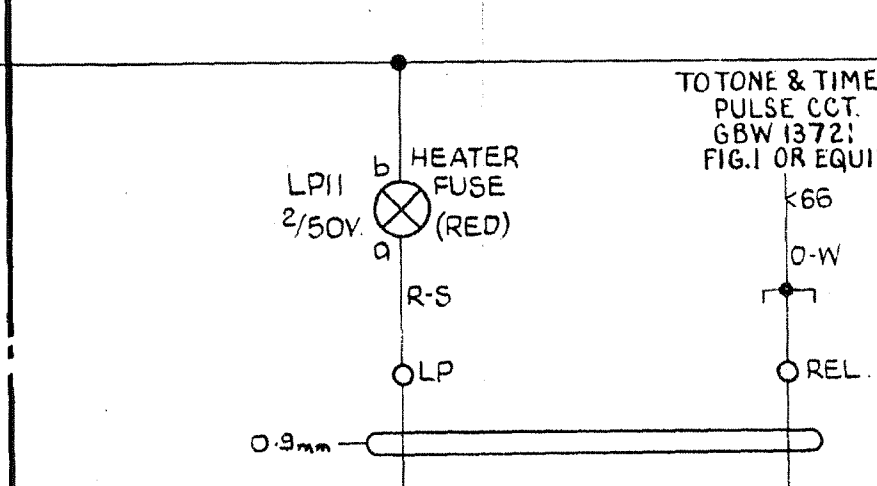

FIG.32A 1 PER UNIT 'S'

FIG.33 50V. POSITIVE SUPPLY FAIL ALARM
1 PER GRP. OF UNITS 'S'

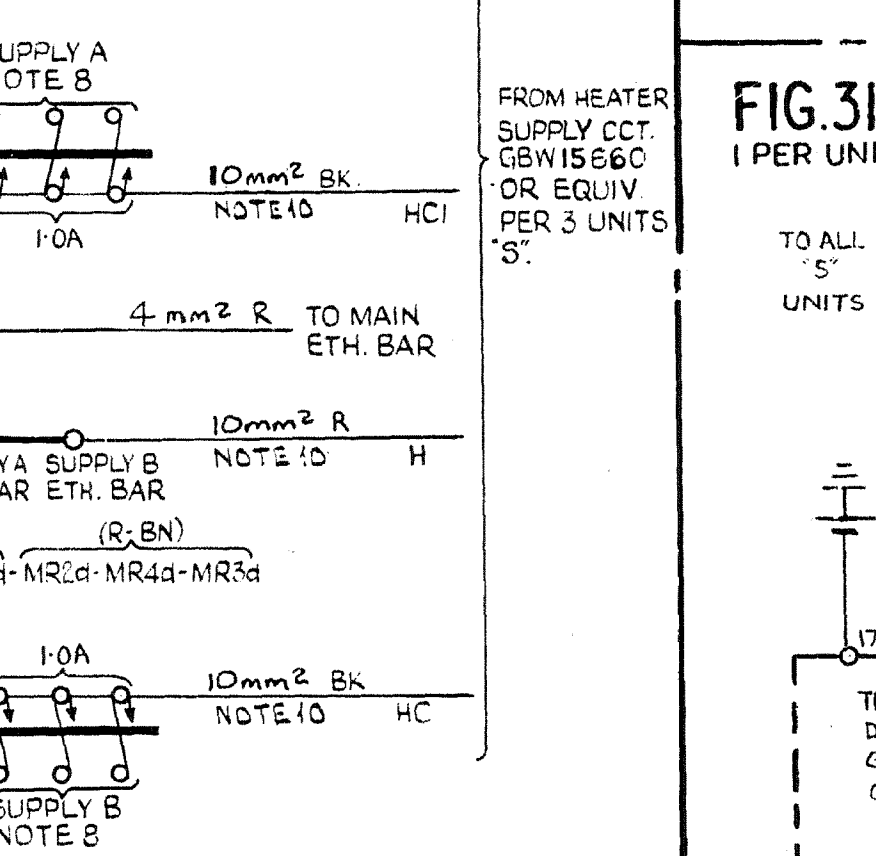
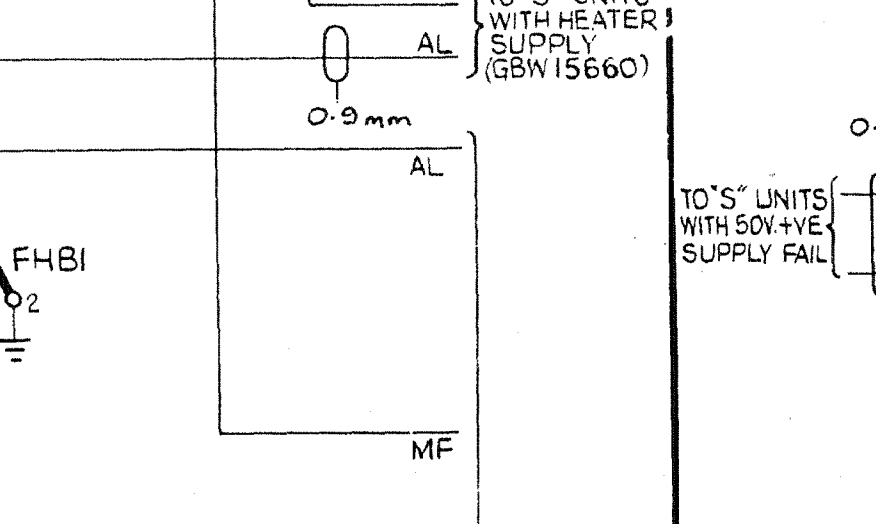
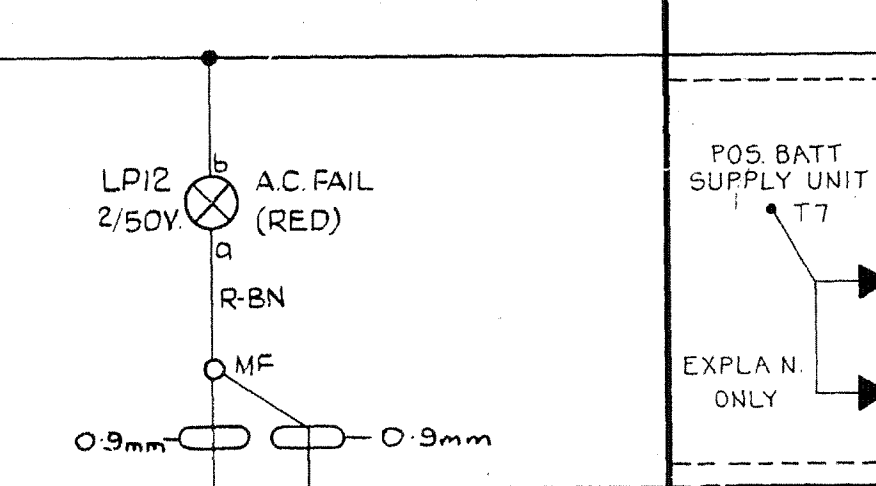

FIG.33A EXPLANATORY ONLY (PART OF GBW.15670)
1 PER 10 I.V.F. LINE CCTS.

FIG.34 2280~ DISTRIBUTION (A.C.3)
(2 OSCILLATORS PER 15 B/W CCTS.)
1 PER 1ST, 4TH ETC. UNITS ('S')

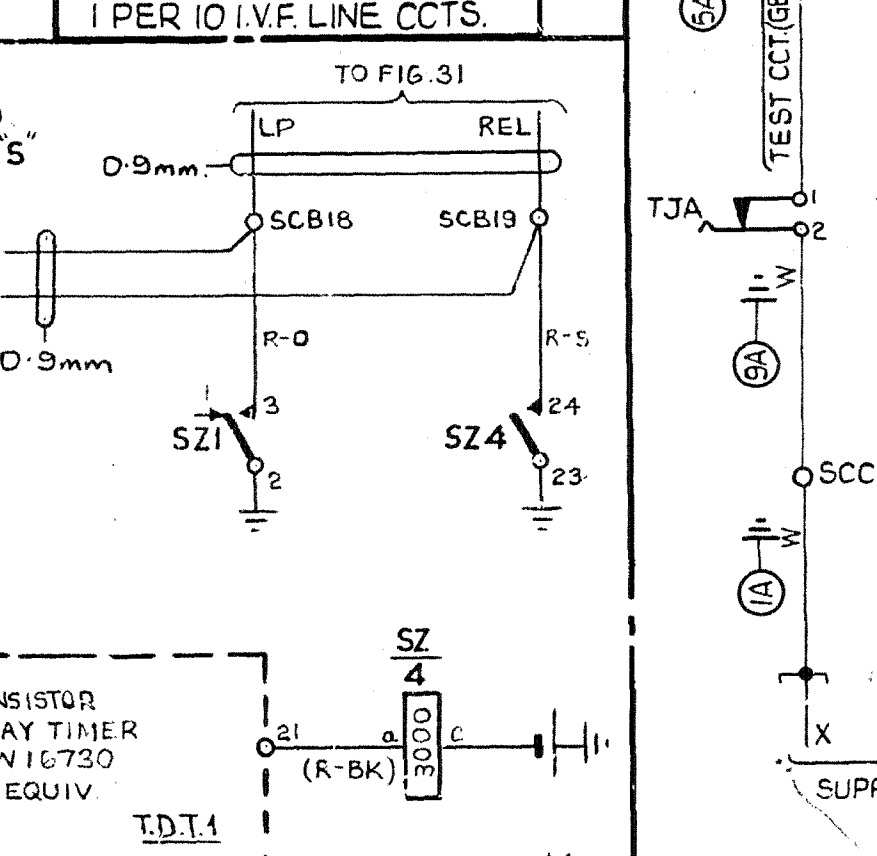
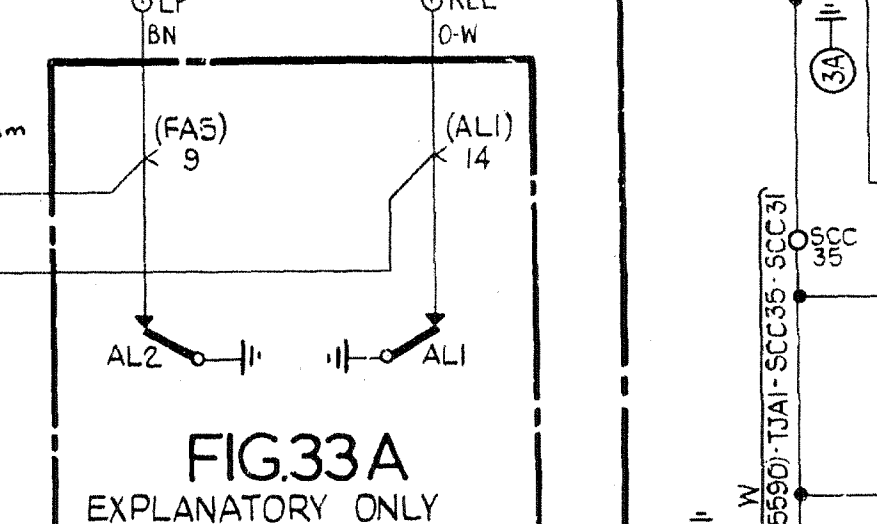
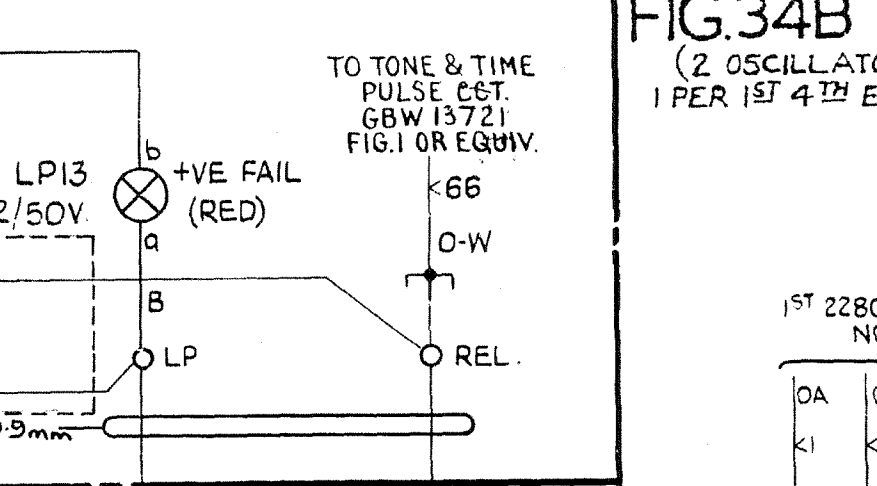

FIG.34B 2280~ DISTRIBUTION (A.C.3T)
(2 OSCILLATORS PER 15 B/W CCTS.)
1 PER 1ST 4TH ETC. UNITS ('S')

FIG.35 50V.-VE BATT. FUSE ALARM
& OSCILLATOR FAIL ALARM.
1 PER UNIT ('S')

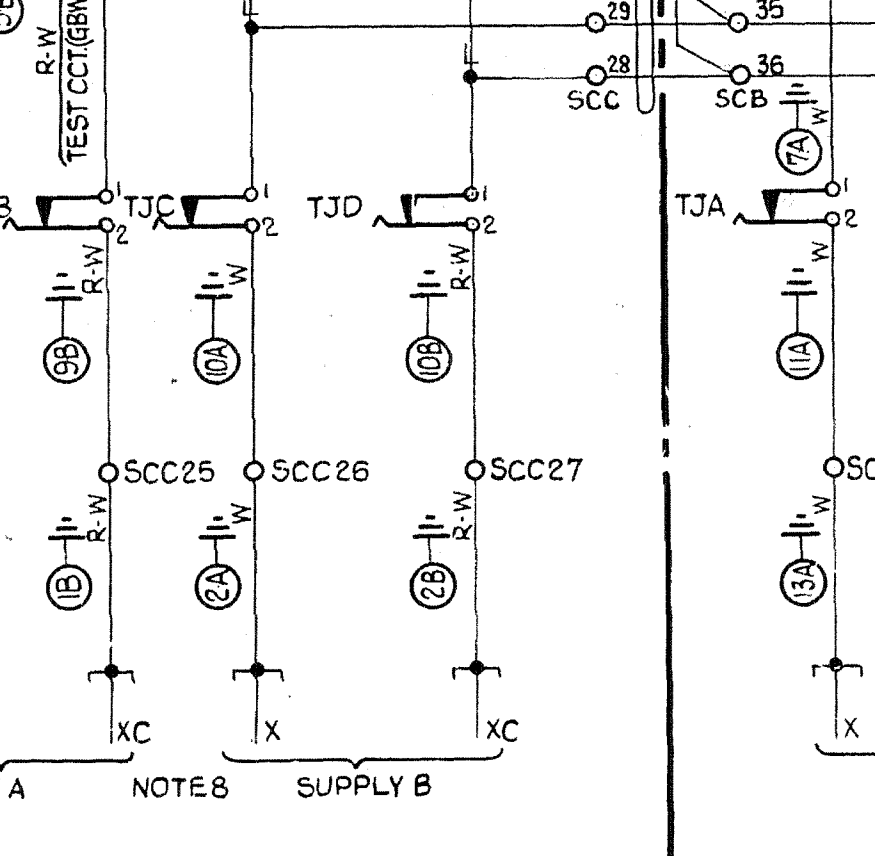
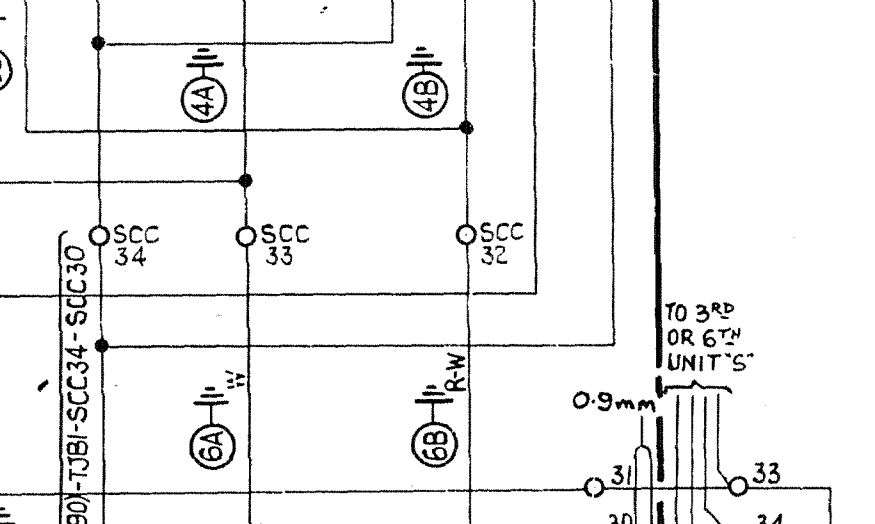
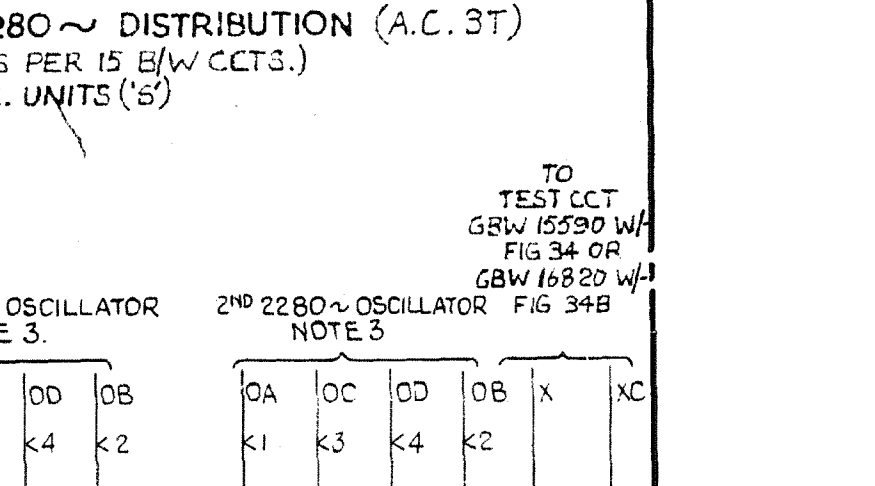

FIG.35A 1 PER UNIT 'S'

FIG.36 2280~ DISTRIBUTION (A.C.3T)
(2 OSCILLATORS PER 15 B/W CCTS.)
1 PER 1ST 4TH ETC. UNITS ('S')

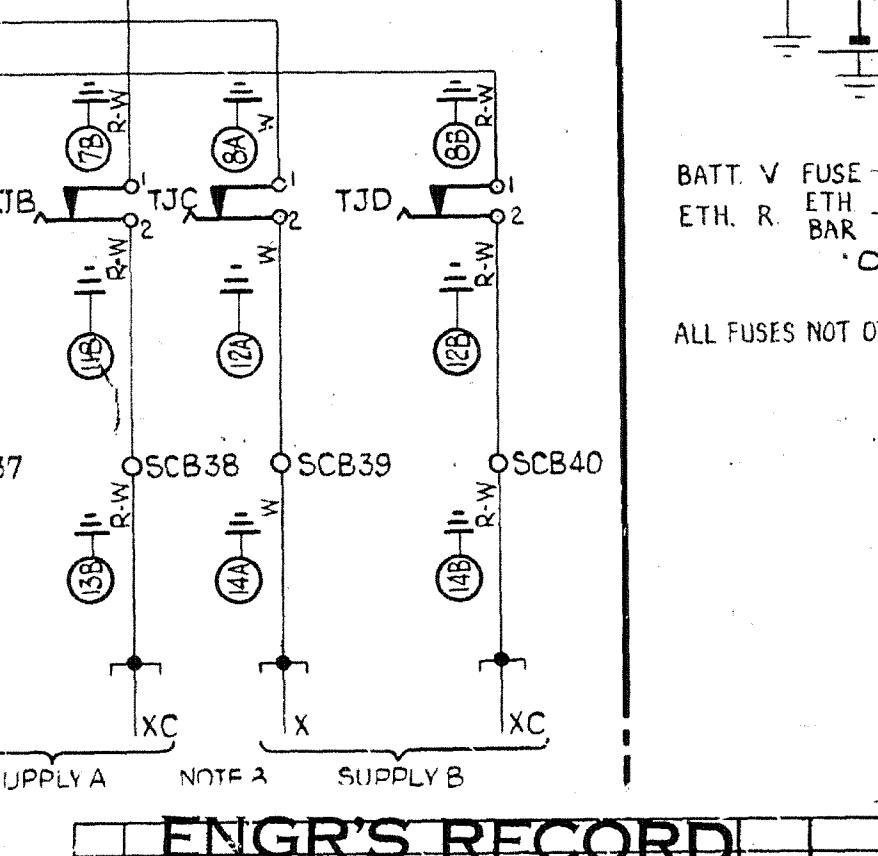
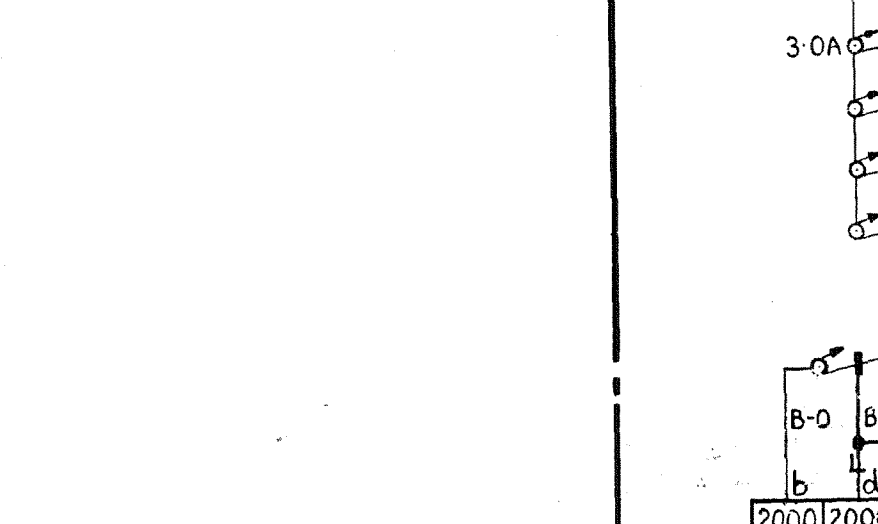
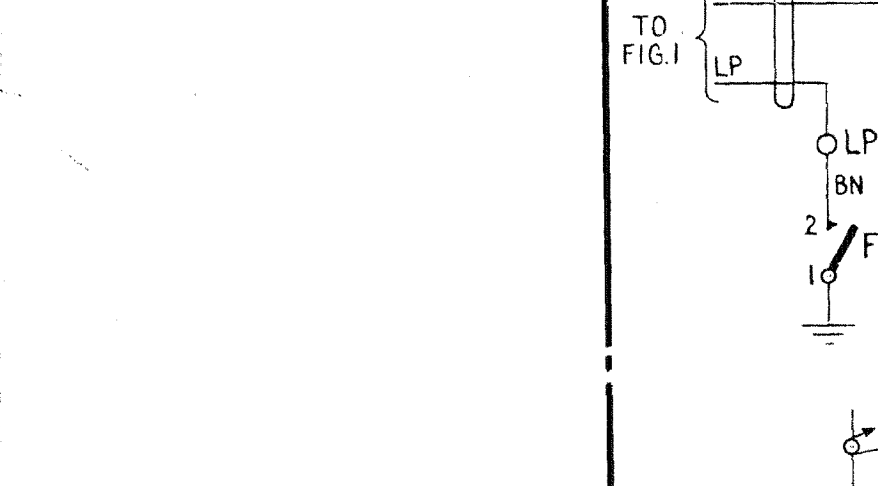

FIG.36A 1 PER UNIT 'S'

ENGR'S RECORD			
CHANGE COLUMN CORRECTION. (189088)	21A	24-3-82	LJF
FIG 33 POS BATT SUPPLY UNIT ADDED (176446)	21	19-11-81	LJF
REPLACEMENT TCG INCORP (99911)	20A	24-8-73	B5-H
ME TRIC WIRE SIZES WERE S.W.G (39926)	20A	17-2-72	B5-H
ISSUE ADVANCED NO CHANGE.	19		
AMENDMENT PARTICULARS	ISSUE DATE	APPRO	SIZE L 50V. C

FIG.37 2280~ DISTRIBUTION (A.C.3)
(2 OSCILLATORS PER 15 B/W CCTS.)
1 PER 1ST 4TH ETC. UNITS ('S')

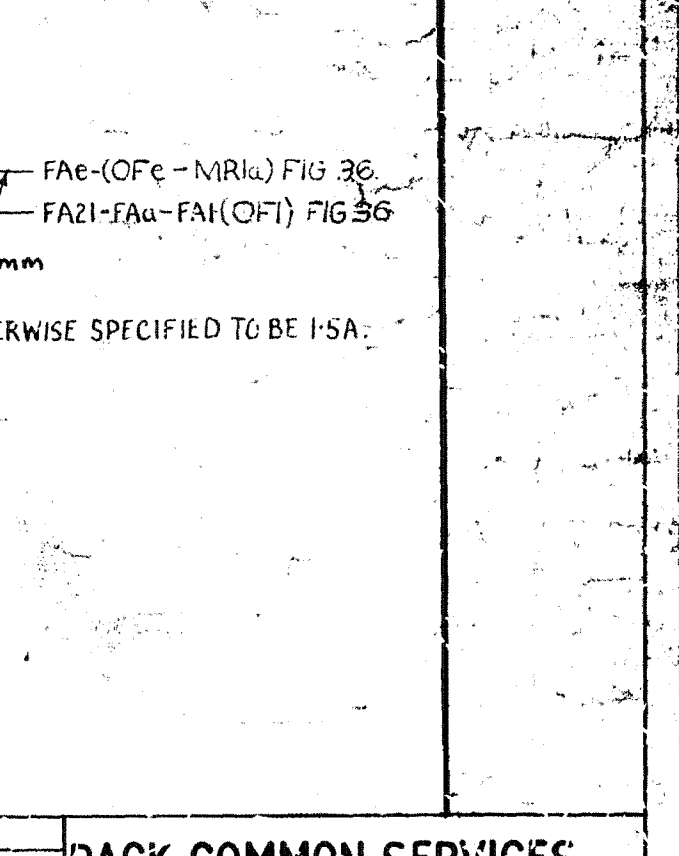
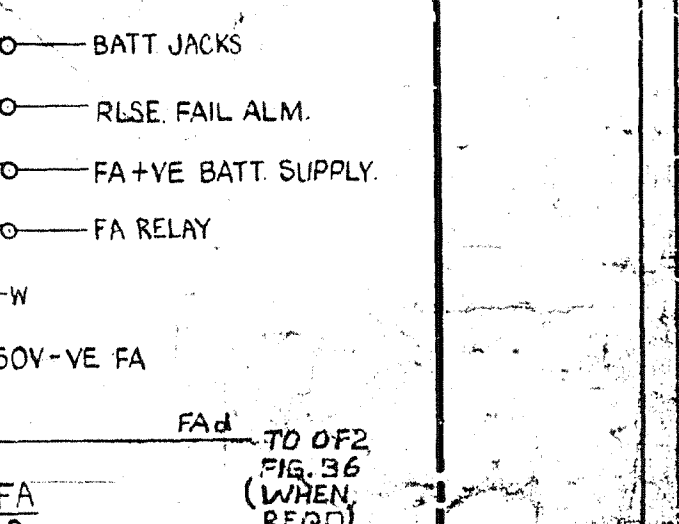
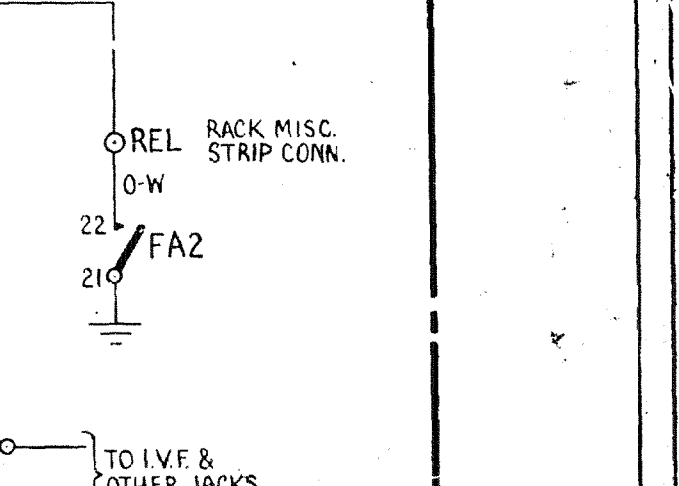

FIG.37A 1 PER UNIT 'S'

RACK COMMON SERVICES			
N.Z. U.A.X. No.13 UNITS			
AUTO EXCHANGE & I.V.F. SYSTEM			
NZPO	2, r	PH	PH

