

FIG.1A
FUSE ALARM

FIG 2
RELEASE ALARM
1 PER SELECTOR

FIG 3
BATTERY JACKS
1 PER PABX

FIG 4
RING START
1 PER PABX

FIG 5
LINE START
1 PER PABX

FIG 6
PULSE START
1 PER PABX

FIG 7
DIAL TONE
DISTRIBUTION
1 PER PABX

FIG 8
BUSY TONE
DISTRIBUTION
1 PER PABX

FIG 9
RING TONE
DISTRIBUTION
1 PER PABX

FIG 10
WARN TONE
DISTRIBUTION
1 PER PABX

NOTES

- ORDER OF CIRCUITS IN WIRING RUN READ FROM TOP TO BOTTOM
- EXCEPT WHERE OTHERWISE STATED, ALL WIRING BEARING A COLOUR CODE TO BE IN 23 SWG.
- UNLESS OTHERWISE SPECIFIED TAGS ARE ON MISC STRIP CONN
- GBW NUMBERS IN BRACKETS REFER TO EQUIPMENTS MANUFACTURED TO SPECIFICATIONS OS 1035 & OS 1058 BRACKETS WITH NO NUMBER INDICATE THAT THE CONNECT ON DOES NOT EXIST ON THESE EARLY EQUIPMENTS
- WHEN EXTENSION 89 IS A DISTANT EXTENSION VIA A CARRIER SYSTEM CONNECT Fb & NE23 WIRE TO INT RING & INT RING RET

EXPLANATORY
PART OF MISC CCTS
GBW 14720 (13270) OR EQUIV

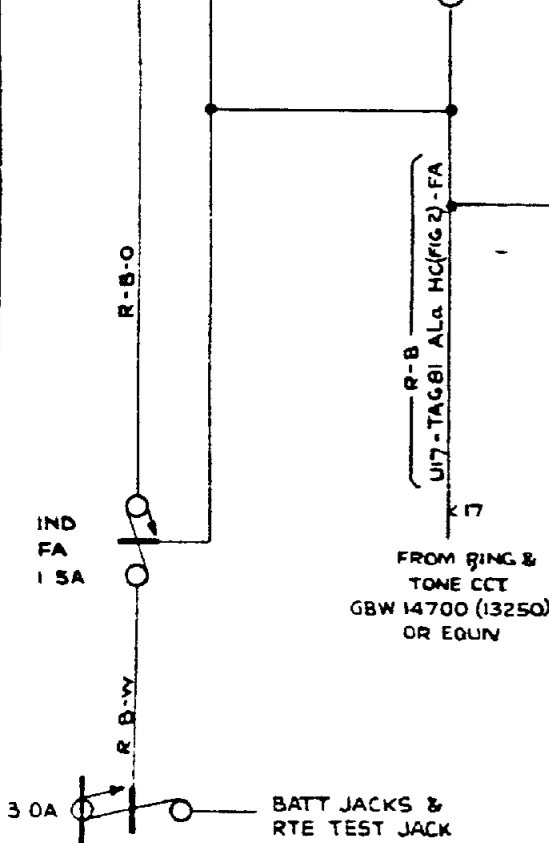
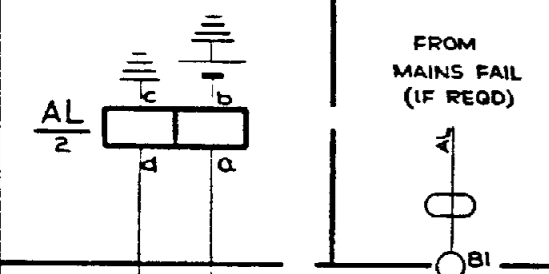
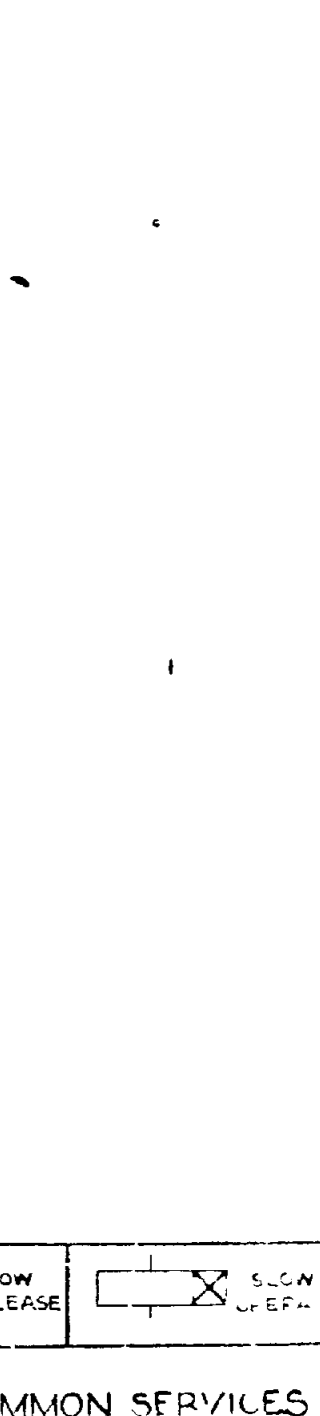
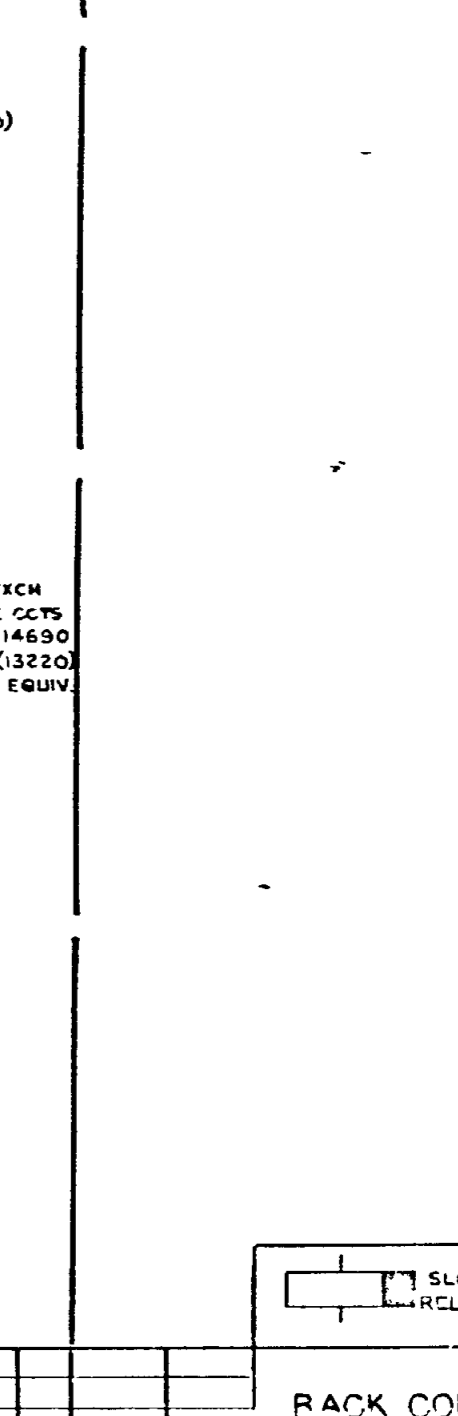
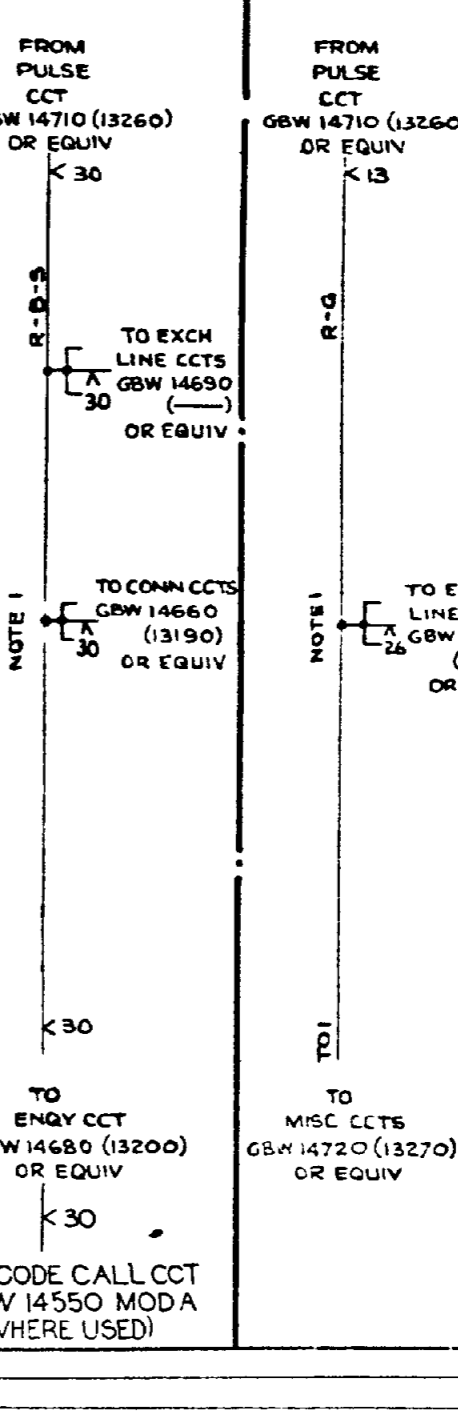
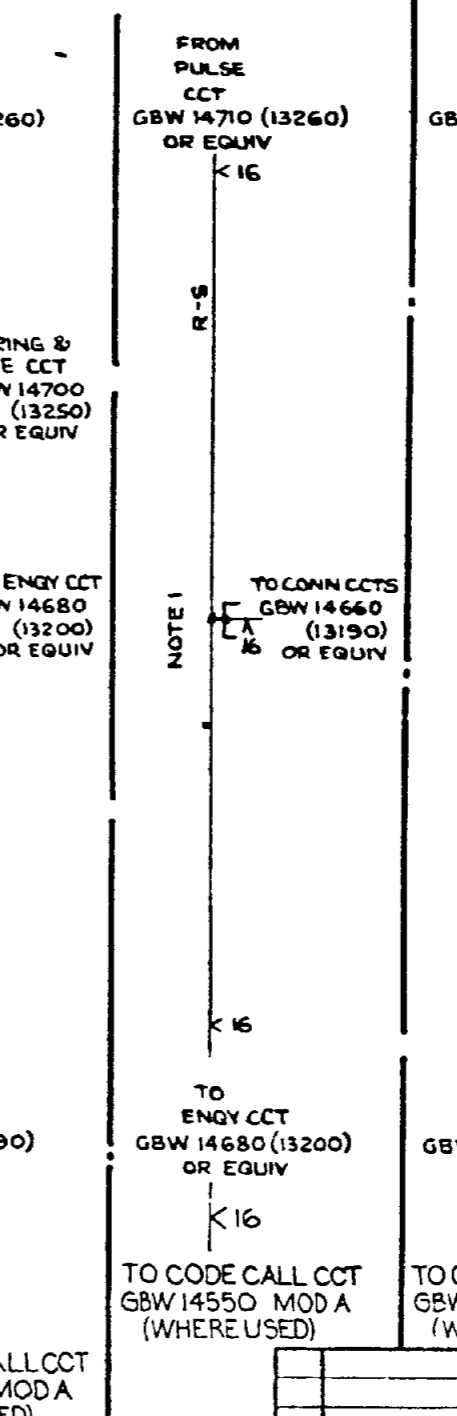
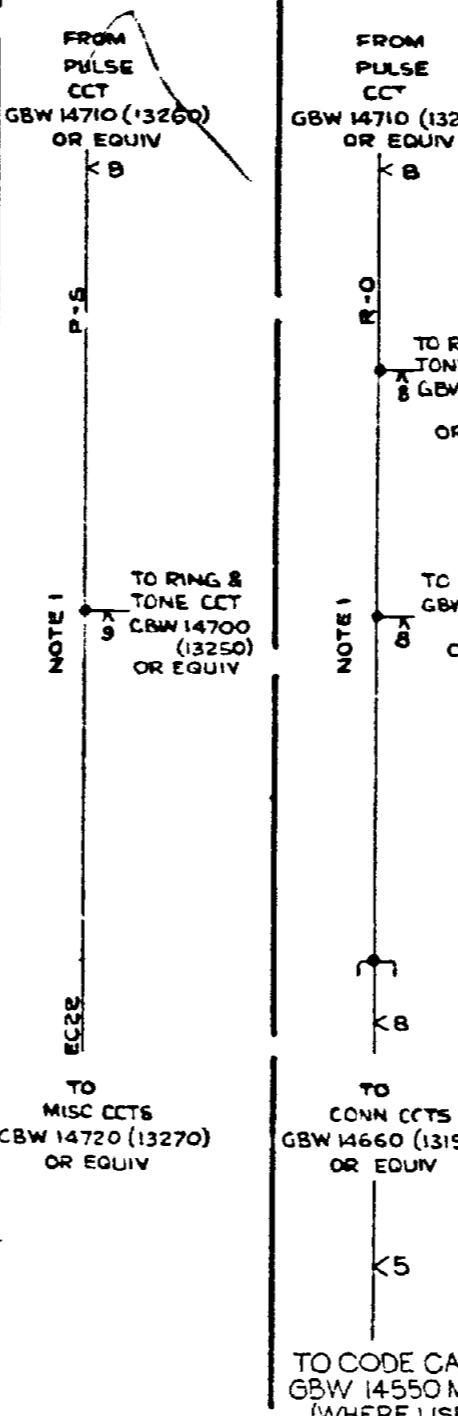
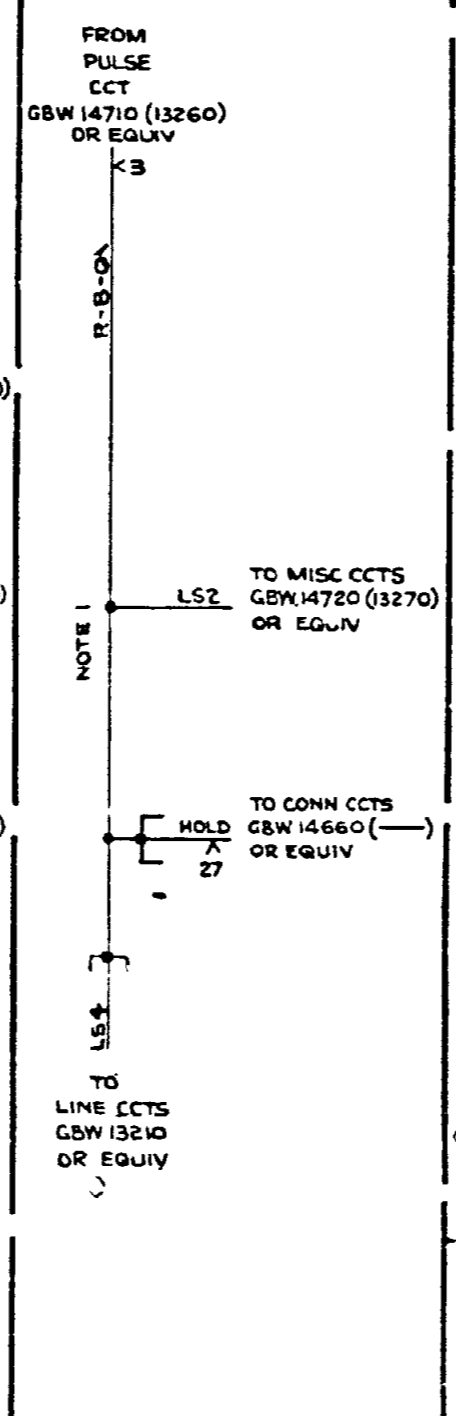
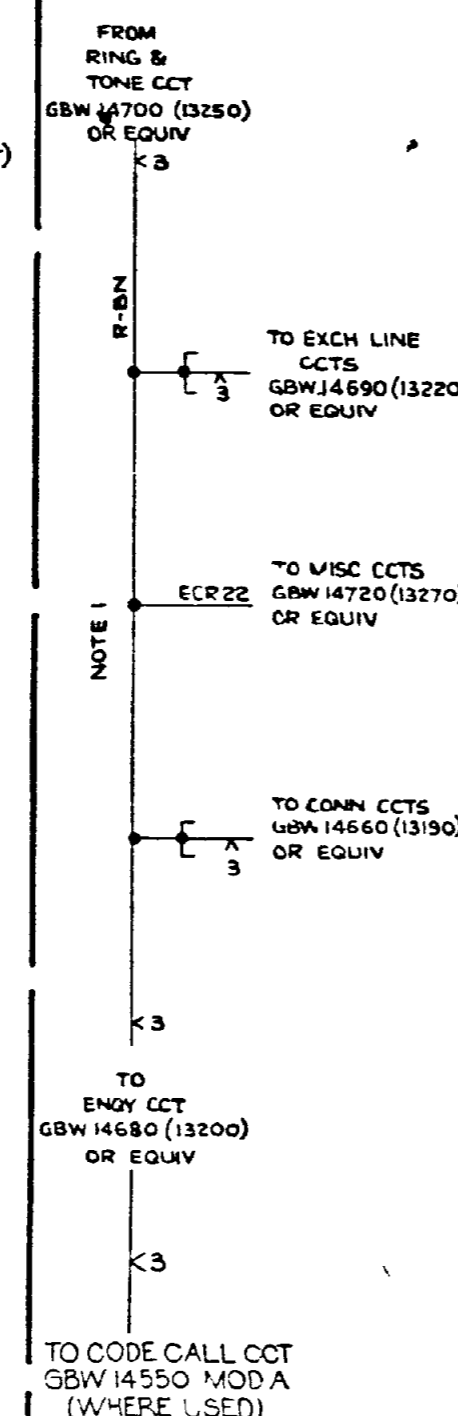
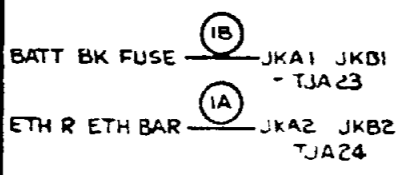
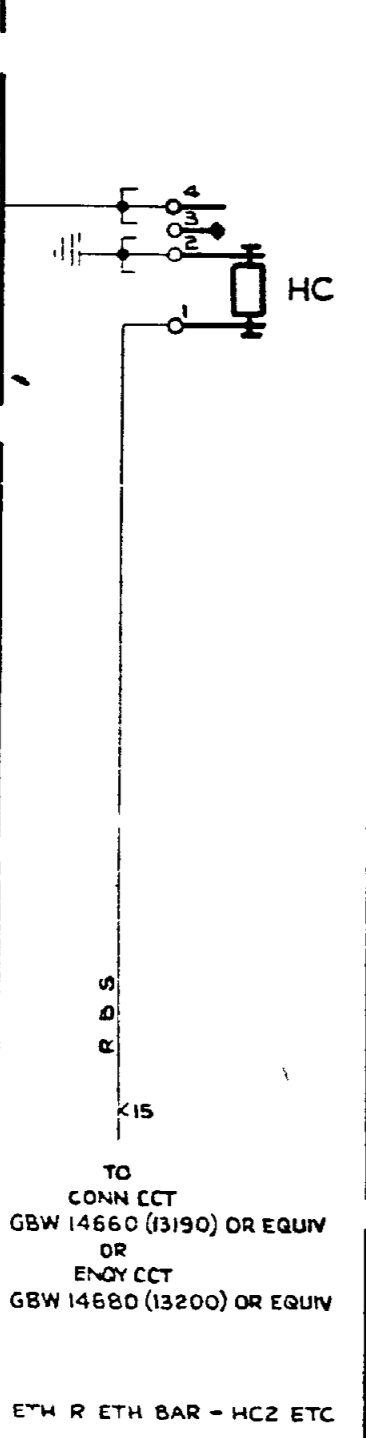

FIG 1B
PER PABX



SLOW RELEASE		SLOW REPEAT	
RACK COMMON SERVICES 35 & 49 LINE FABX WITH AUXILIARY SERVICES			
OLE 5	ADDED	(30497)	B 29 6 72 G.F.E.
REPL	REPL	(23277)	A 13 6 80 LW.H
AMENDMENT	PARTICULARS	SSLT	DATE APPD
NZ PO		DRAWN	CHECKD
		MR G	CLYD
GBW 13300 MOD A			

FIG 11

INTERRUPTED RINGING DISTRIBUTION 1 PER PABX.

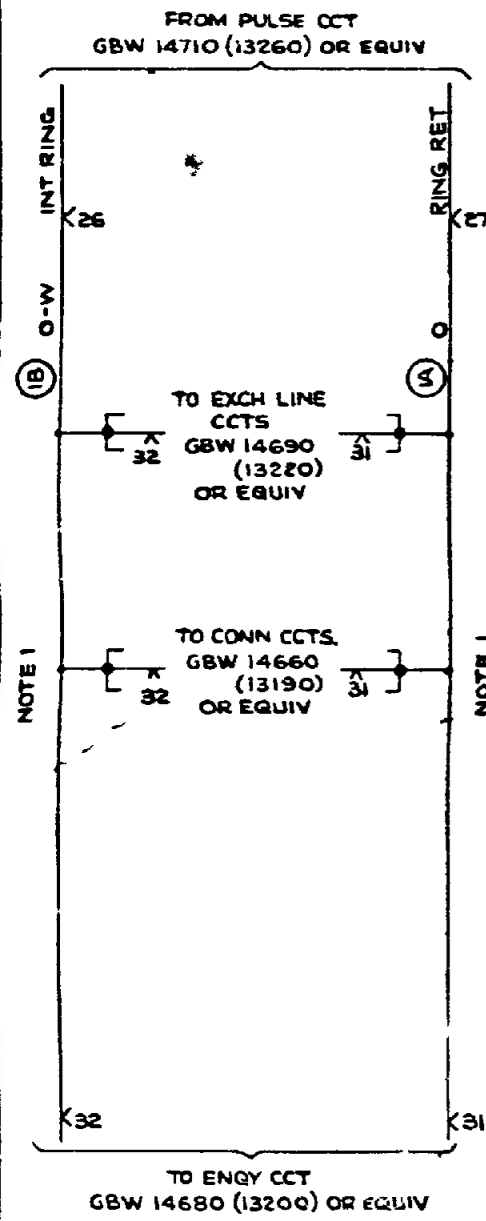

FIG 12

CONTINUOUS RINGING DISTRIBUTION 1 PER PABX. NOTE 5

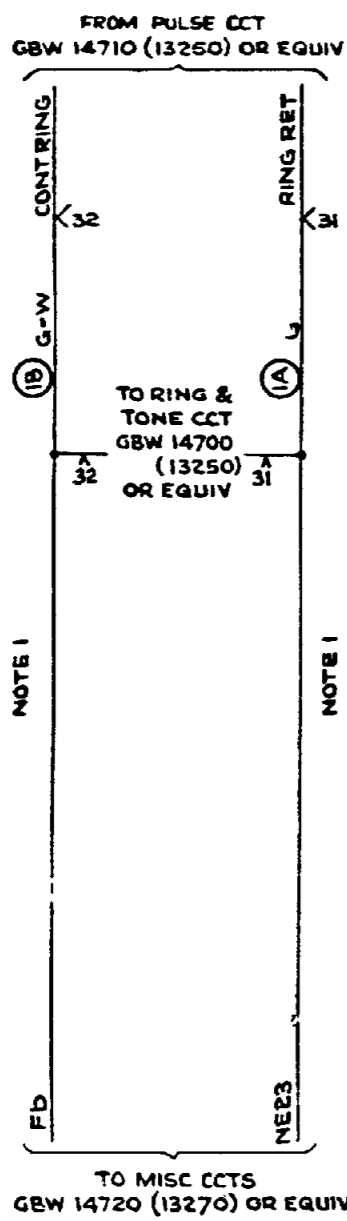

FIG 13

BUSY ETH DISTRIBUTION 1 PER PABX

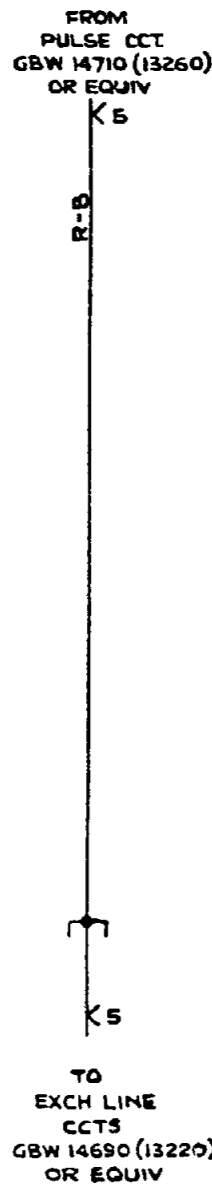

FIG 14

FLICKER ETH DISTRIBUTION 1 PER PABX

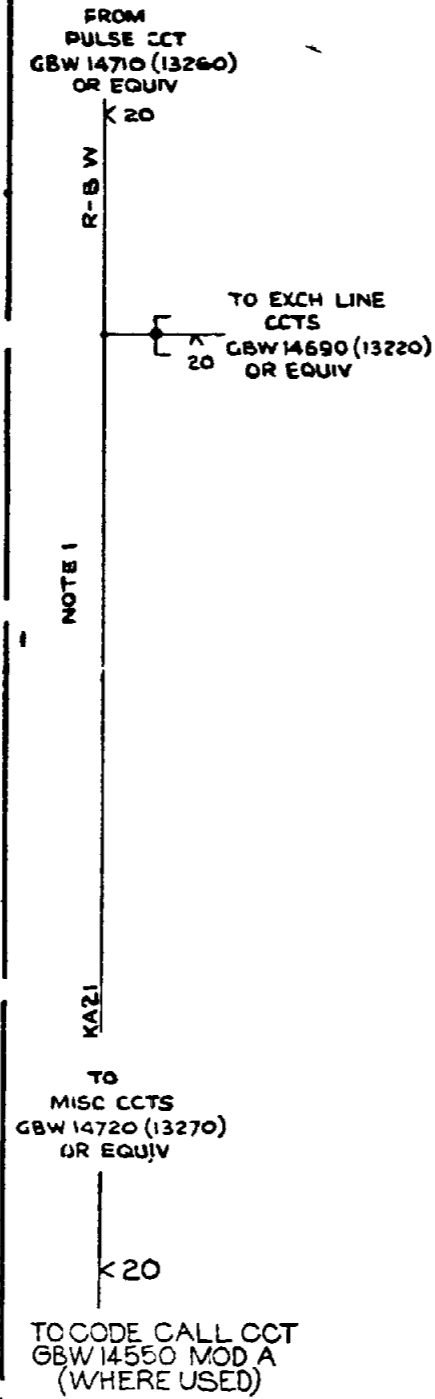
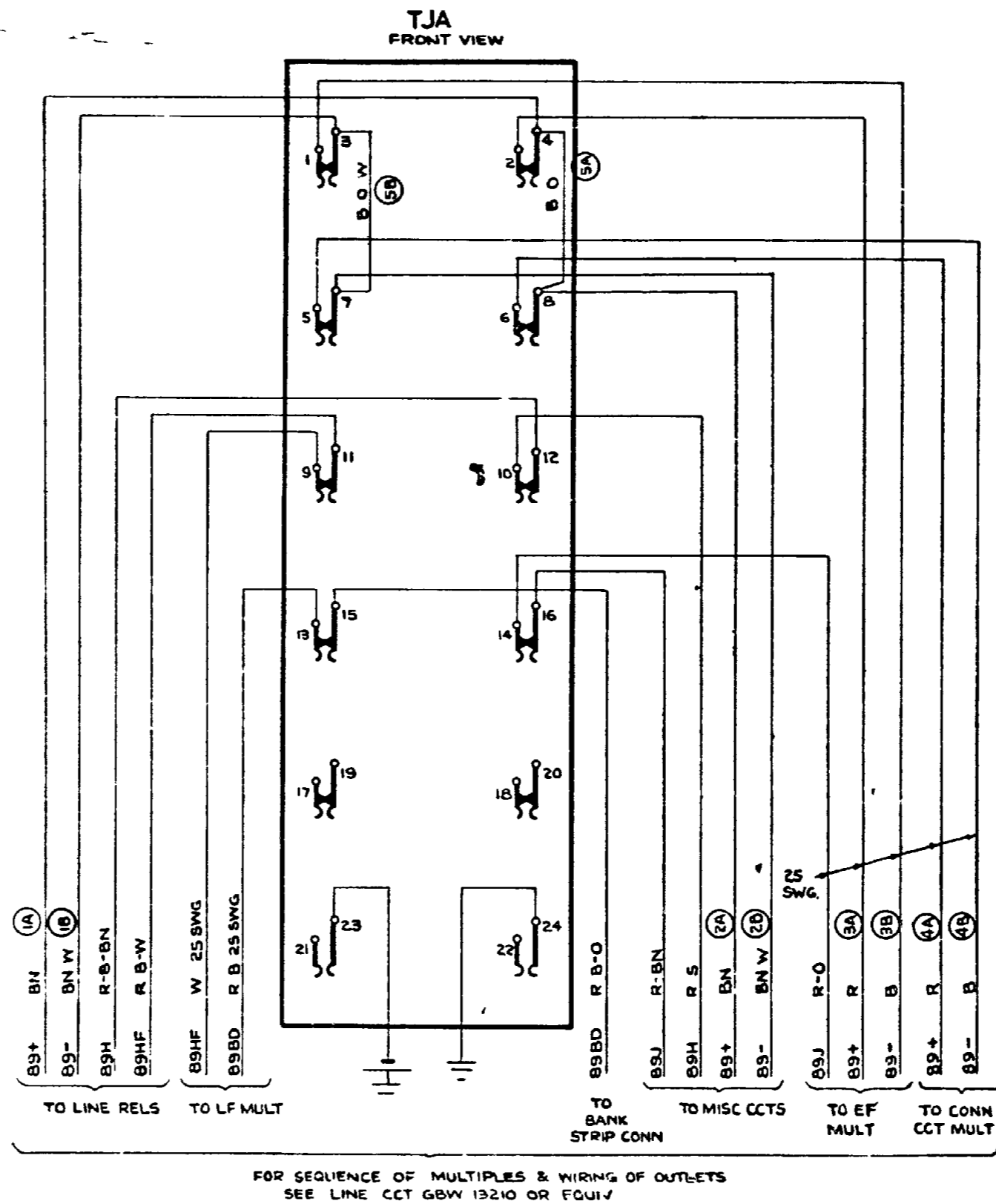

FIG 15

ROUTINE TEST JACK 1 PER PABX



FOR BATT & ETH RUNS SEE FIG 3

		<input type="checkbox"/> SLOW RELE-SE		<input checked="" type="checkbox"/> SLOW OPERATE	
RACK COMMON SERVICES 35 & 49 LINE PAB X WITH AUXILIARY SERVICES					
REFERENCE TO NOTE 5 ADDED (30497)		B	29 6 72	GFE	
PREPARED FROM 10B 113200 ISSA OF 11-55 (22277)		A	13 6 60	LWH	
AMENDMENT	PARTICULARS	ISSUE	DATE	APPD	
		SIZE M		50V	W
GBW 13300 MOD A SHT					22
NZPO	DRAWN TB	CHECKED	WIRING	CIRCUIT	